

ANNALS OF
HORTICULTURE

L. H. BAILEY

EX-LIBRIS

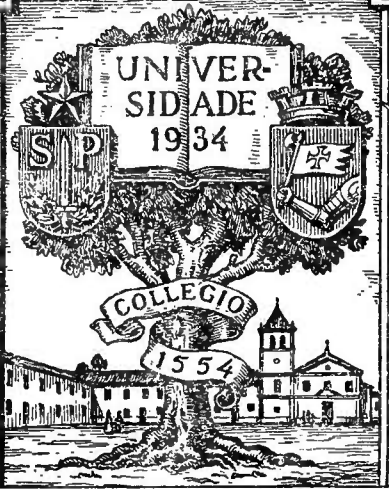

UNIVERSIDADE DE SÃO PAULO
ESCOLA SUPERIOR DE AGRICULTURA
LUIZ DE QUEIROZ

J.W.R.

Nº 1035

~~570~~

~~58~~

101 23 20-2

635

B155

Annals of Horticulture

IN NORTH AMERICA

FOR THE YEAR 1889

A WITNESS OF PASSING EVENTS AND A RECORD OF
PROGRESS

By

L. H. BAILEY

COPYRIGHTED 1889

NEW YORK :
RURAL PUBLISHING COMPANY
1890



By the same Author.

HORTICULTURIST'S RULE-BOOK.

A compendium of useful information for Fruit-Growers, Truck-Gardeners, Florists and others. Completed to the close of the year 1889. Flexible cloth, small 12mo, 236 pages. Price, \$1.

It is just such a portable book as many practical and experimental gardeners will want at hand, for its condensed information on the multitude of subjects which are constantly coming before them.—
JOHN J. THOMAS.

We have never seen in any similar treatise a collection of facts so comprehensive, so practically instructive, so concisely and accurately stated.—
E. S. CARMAN.

It is difficult to conceive how a greater amount of practical, every-day information relating to fruits and vegetables could be condensed into smaller compass than is contained in this manual.—
F. M. HEXAMER.

PREFACE.

A series of Annals of Horticulture, of which the present volume is the initial, is projected for the purpose of preserving in convenient form a record and epitome of yearly progress in horticulture. Our horticultural interests are becoming so various and extensive, and records of them are so widely scattered, that such compendiums are a necessity; and summaries of the most important discoveries and discussions must have a direct and immediate practical use, wholly aside from their values as history.

A leading feature of the series must necessarily be complete records of the introduction of horticultural plants; and the author desires that these volumes shall comprise the standard publication of new varieties. So far as record is concerned these publications can serve the purpose of the certificates issued for new varieties by the Royal Horticultural Society in England, and by similar organizations in other countries; and to this end, all North American originators and introducers are solicited to make records of their novelties and introductions. It certainly requires no argument to convince both dealer and purchaser that all interests will be greatly subserved by such annual records.

Complete lists of all the varieties of fruits, kitchen garden vegetables and ornamentals now cultivated in North America, are needed. Such lists are indispensable to an understanding of the present condition of our horticulture, and they become

more valuable in each succeeding year as matters of history. They would furnish invaluable material for the study of the direction and extent of variation in cultivated plants; and, as varieties increase, they should serve a purpose in preventing the duplication of varietal names. A contribution to such comprehensive record has been made in this volume, in the insertion of a list of all the varieties of kitchen garden vegetables now cultivated in North America, so far as the names can be learned. The list has been prepared at immense labor and with great care. It is expected that similar lists for fruits and ornamentals will be added in other years.

The present volume is in many directions fragmentary and incomplete in design. It is prepared under the pressure of many new enterprises, and it has the faults inherent in new ventures. It is particularly desired that future volumes shall be broader in their scope, and that European horticulture, particularly in all its relations to our own, shall receive greater attention. It is the purpose to present in each volume a few fresh and attractive accounts of the horticultural interests of other countries, in extension of the plan already inaugurated in our last chapter.

The author is aware that accumulations of the year can never be complete unless the horticulturists of the country co-operate in making them, and he will be grateful for any facts which are worthy of record.

L. H. BAILEY.

GARDEN HOME, ITHACA, N. Y.

December 31, 1889.

CONTENTS.

PART I—General Annals.

CHAPTER I.

YIELDS AND PRICES OF 1889.	9
----------------------------	---

CHAPTER II.

FRUIT INTERESTS.	16
1. Trees and Shrubs for the Cold North	16
§ 1. For the Prairie States.	
§ 2. For the Northeast.	
2. The Newer Fruits of the South . .	21
§ 1. Notes on New Southern Fruits, with Particular Reference to Southern Florida. By E. N. Reasoner.	
§ 2. Notes on Florida Peaches. By G. L. Taber.	
3. Tendencies in California Horticulture	26
4. Oriental Fruits.	28

CHAPTER III.

ORNAMENTALS	33
1. Recent Tendencies in Ornamental Gardening and in Ornamentals	33
§ 1. Evolution in Taste.	
§ 2. General Notes on Ornamentals. By F. L. Temple.	
2. Chrysanthemums	39
§ 1. Brief History.	
§ 2. Chrysanthemum Notes. By Edwin Lonsdale.	

CHAPTER III.—ORNAMENTALS: *Chrysanthemums*, continued.

- § 3. Chrysanthemum Shows of 1889. By John Thorpe.
 § 4. Some of the New Chrysanthemums. By John Thorpe.
 § 5. Chrysanthemums of 1889. By H. P. Walcott.
3. Roses. By E. G. Hill. 55

CHAPTER IV

PLANT DISEASES AND INSECTS.	59
1. Vegetable Pathology	59
2. Economic Entomology	61
3. Arsenites for the Plum Curculio.	63
4. Desirability of Laws to Control Insect Ravages and Plant Diseases.	69

CHAPTER V.

NATIONAL AND EDUCATIONAL INTERESTS.	71
1. Horticultural Work of the National Department of Agriculture	71
2. Horticultural Work of the Experiment Stations.	75
3. Irregularities in Weights and Measures	80
4. The National Flower Discussion	82
5. Missouri Botanic Gardens.	83

CHAPTER VI.

CONVENTIONS OF NATIONAL SOCIETIES PERTAINING TO HORTICULTURE FOR THE YEAR 1889	86
1. American Pomological Society	86
2. Society of American Florists	87
3. American Association of Nurserymen.	91
4. Association of American Cemetery Superintend- ents	92
5. The Northwestern Cider and Vinegar-Makers' Association.	92
6. American Seed Trade Association.	94

PART II—Special Annals.

CHAPTER VII.

ANNALS OF PLANTS ..	96
1. Introductions of 1889	96
2. Catalogue of American Kitchen Garden Vegetables	106
3. Plant Portraits of 1889.	141

CHAPTER VIII.

DIRECTORIES. ..	157
1. Directory of the National, State, Provincial and other Most Important Horticultural Societies in North America ..	157
2. List of Horticulturists, or Horticulturists and Botanists, of Experiment Stations in North America ..	162
3. The Botanic Gardens of the World	164
4. Some American Seedsmen and Nurserymen	169

CHAPTER IX.

TOOLS AND CONVENIENCES OF THE YEAR	174
------------------------------------	-----

CHAPTER X.

RECENT HORTICULTURAL LITERATURE	193
1. Register of Experimental Horticulture	193
§ 1. Title Index.	
§ 2. Subject Index.	
2. Books of 1889 ..	213
3. Horticultural Periodicals of the World	214

CHAPTER XI.

NECROLOGY OF 1889.	217
--------------------	-----

CHAPTER XII.

HORTICULTURE IN OTHER LANDS ..	231
1. Horticulture in Paraguay. By Dr. Thomas Mor- ong	231
2. Trees and Fruits of the "Palm Hills" of India. By Rev. S. B. Fairbank	240
Index ..	245





ORTICULTURE may be divided into four general subjects: Pomology, Olericulture, Floriculture and Landscape Horticulture. Pomology considers the science and culture of fruits, olericulture has to do with vegetable gardening, floriculture grows herbaceous or various small plants for their individual merits as objects of ornament, while landscape horticulture shapes and applies the conceptions of landscape gardening and is well nigh inseparable from it. Each of these subjects may be again divided into many divisions, any one of which is large enough to absorb the thought and practice of a lifetime. There are perhaps no branches of business which include so many diverse subjects and practices as horticulture. Even agriculture or general farming, in the restricted sense in which we now use these terms, is much less various in its constitution than this. The breeds and families of domestic animals are many times outnumbered by the species of plants which fall to the domain of horticulture, while all the practices of general agriculture are much fewer and mostly less various than those required of the horticulturist.

Horticulture considers an immense range of industry and appeals to widely diverse motives and emotions. In particular, it appeals strongly to all the finer instincts, demanding a high appreciation of expression in nature, and inspiring an elevated feeling for works of art. It is also a vocation of specializations. Particular and explicit knowledge is nowhere more needed than here; and watch-

fulness of every detail in a multitude of plants and endeavors is essential to success. So it comes that horticulturists are usually good observers. In fact, in the finer branches, good observation is the chief requirement and the most important stock in trade. As horticulture appeals to the emotions as well as to the simple requirements of existence, it follows that it becomes a most fitting vocation for a full and happy life. All this demands a culture in the individual, and a keenness of perception which few occupations require; for occupations are rare in which high emotion is necessary to the conduct of their elementary principles. All the beauty and variety of contiguous nature and the most interesting types of the vegetation of the world, become plastic materials in the hands of the cultivator. It is but a step from all this material form and color into that larger realm which composes landscapes and paints imaginations, a step so small that horticulture all but passes into fine art.

Unhappily, there are comparatively few horticulturists who possess the delicacy of feeling necessary to the full enjoyment of the art, and there are perhaps fewer still who have the special knowledge necessary to the largest material success. There are few, even, who know the scope of horticulture. Pomology and floriculture are so widely separate in the minds of most cultivators that no affinities are seen between them. The horticulturist must possess both narrowness of application and breadth of view. He not only needs books, but he must have them. To read and to digest his thoughts must become a part of his business rather than wholly his pleasure.

PART I

CHAPTER I.

YIELDS AND PRICES OF 1889.

In general, fruit crops have been under the average, and prices have ruled good to high. The causes of the light crops are difficult to determine. The failure in the apple crop in many parts of the country is largely if not entirely the result of very heavy crops last year. Cold weather, yellows and insects have lessened the peach crop. Continued cold and wet weather in most parts of the east has seriously interfered with many fruits and vegetables. In a large part of the Mississippi Valley and westward to the mountains there has been very dry weather, and in many regions drought has been excessive. Very dry weather early in the season lessened production in some parts of the south. Late rains have injured the raisin, grape and other crops of California.

The apple crop has been light, as a whole. The large apple growing districts of New York produced almost nothing for market, and all through New England the production was very small. In Illinois the crop was light to fair. Michigan, on the contrary, produced an enormous crop, it being estimated at a million barrels, probably half of the entire crop of the United States. Missouri and Kansas also gave fair crops. The western crop is in less demand for exportation than the eastern, and as a consequence European shipments have been comparatively small, and prices have ruled high. The total exportations from North American ports for the week ending

November 30th were 417,421 barrels, against 879,096 for the corresponding week in 1888. This may be considered an average measure of the extent of foreign shipment this year as compared with last. The apple crop of Europe was light, on the whole. England had a small crop, Scotland fair, France and Belgium very poor, Holland small, Germany fair to good. Denmark has had a large and fine crop, however, and the fruit has come into direct competition with the American product. Northern Spain has also put considerable fruit upon the English market, for the first time in the history of active American exportation.

Tasmania is now sending apples to the English markets. The first shipments from Tasmania to London were made about three years ago. They come on the market after the shipments from North America and Europe have ceased, and therefore command good prices. They closely resemble American apples in color and general appearance. These southern fruits cannot compete with the American product, however, as they arrive out of season and the price paid for American apples would not be remunerative to Tasmanian growers. The long distance through which they must be transported demands thorough packing. They arrive in crates holding about 40 pounds of fruit.

Peaches were generally a light crop in the eastern United States. The orchards on the Delaware and Chesapeake peninsula produced less than half a full crop, and probably less than two-thirds an average crop. The larger yields were in the lower two-thirds of the peninsula. In the northern counties hundreds of orchards gave no crop; a few yielded sparingly and a very few produced a nearly full crop on some varieties. Prices on the peninsula have ruled high. Along the railroad in Delaware the best yellow fruit sold for \$1 to \$1.40 per basket of five-eighths bushel. A poor quality of white fruit brought from 40 to 60 cents, and the best white fruit sold as high as 90 cents and \$1. The Michigan crop was light but fine. The center of peach growing in the famous Michigan fruit belt lies in Allegan county, but the crop there was exceedingly light, while in Berrien county, at the southern limit of the peach growing district, the crop was fair. In Southern Illinois the crop was poor, owing, in large measure, to the depredations of insects. Through the south

an average crop was obtained. In Georgia, however, the crop was probably the best ever grown. But the crop is usually neglected in the south, and it does not attain the importance that it might in northern markets. The peach interests of the east are suffering seriously from the yellows. In Delaware, for instance, the capacity is scarcely more than a third as great as ten or even fewer years ago. The Michigan growers have fought the disease vigorously and are suffering little.

Grapes were fair to good in New York, a failure in the fruit region of Michigan, and the New Jersey, Delaware, and Southern Illinois crops were much injured by rot.

The Florida orange crop is considerably below that of 1888, owing to the very dry weather of April and May. The output this year will probably not exceed 1,600,000 boxes, while the crop of last year was about 2,000,000 boxes. This reduction means more than a shortage of 400,000 boxes, for more trees are coming into bearing each year. The crop will probably bring remunerative prices to growers, and yet it is large enough to supply the market at reasonable figures.

Berries have been a good crop generally. In Michigan, Southern Illinois, and throughout the south the yields were fully average to large. Berries are yearly becoming more important in the southern states.

Strawberries have been a heavy crop, but the quality, particularly in the east, has been poor, owing to the cold and wet weather. Most of the large markets were glutted in the height of the season. Yet, on the whole, prices have averaged fair to good. The strawberry market season is constantly lengthening. The New York season now extends over about four months. It opens late in February or early in March with the Florida berries, closing about the first week in July with consignments from Central and Northern New York. Berries from the vicinity of Charleston arrive about two weeks after the Florida crop, and Jersey berries come in about June first.

Cranberries have been a very light crop in New Jersey and the west. In New England the crop has been fair to good. The poor crop in the west and the comparative scarcity of apples have made a brisk demand for cranberries. The American Cranberry Growers' Association state that the New

England crop is $22\frac{1}{2}$ per cent. short, the western crops $37\frac{1}{2}$ per cent. short, while the shortage of the New Jersey crop amounts to 40 per cent. Late advices report the Cape Cod crop to be large. A disastrous hail storm in July is estimated to have destroyed 20,000 barrels of growing fruit, and to have seriously injured the vines. The fire-worm also wrought much damage.

California.—The fruit product in California has been good, on the whole. The total value of the fruit crops of the state has been estimated at \$13,000,000, exceeding the estimate for 1888. The orange crop is estimated at 900,000 boxes. The raisin crop in California was seriously injured by late rains, and much of the crop will be thrown into the poor grades. The total shipments of California fruits, dried, canned and green, for the first ten months of 1889 were 131,083,400 pounds, against 111,225,100 pounds in 1888, and 114,187,000 pounds in 1887. Messrs. Schacht, Lemcke & Steiner, of San Francisco, make the following estimates of the total dried fruit output of California in 1889: Raisins, 19,000,000 pounds, of which 18,000,000 pounds are packed in boxes; prunes, 15,200,000 pounds of French and 200,000 pounds of German and Hungarian; apricots, 2,000,000 pounds; sun-dried peaches, 500,000 pounds; bleached peeled and unpeeled peaches, 2,700,000 pounds; nectarines, 200,000 pounds; pitted plums, 200,000 pounds; apples 400,000 pounds evaporated and 100,000 sun-dried; peas, 50,000 pounds. The 1889 raisin crop is estimated to fill 900,000 boxes; had the weather been favorable, the crop would probably have reached 1,200,000 boxes.

Vegetable crops, in general, have been good, with prices better than last year. The watermelon crop of the south has been large. The importation of cabbages has been large, a single steamer arriving from Copenhagen early in 1890 with a cargo of 4,297 packages.

Potatoes have been a very poor and light crop throughout the east, owing to damage by rot. In many large potato-growing regions the crop which is fit to store is not sufficient to supply the local demand. The crop in some parts of the west has been large, however. It was light in California. Advices from England and Scotland report full and sound crops, and importations will probably be great, yet

the abundance of the crop in the west and in some of the Canadian provinces will probably prevent so large importations as occurred two years ago. The following totals of imports in various years, beginning with October 1st in each instance, will convey an idea of movements in potatoes :

1886-7.	From Great Britain	35,349 sacks.
	" Continent	6,640 " "
	<hr/>	
	Total	41,989 " "
1887-8.	From Great Britain	1,166,205 sacks.
	" Continent	80,083 " "
	<hr/>	
	Total.	1,246,288 " "
1888-9.	From Great Britain	11,301 sacks.
	" Continent	3,685 " "
	<hr/>	
	Total	14,986 " "
1889 (to December 1st).	From Great Britain	11,710 sacks.
	" Continent.	8,220 " "
	<hr/>	
	Total.	19,930 " "

Organizations.—Prices are coming to be largely modified through organizations of growers and merchants. This modification may be in the nature of control through the establishment of a monopoly upon any commodity, or it may be brought about by a better distribution of products and better methods of placing them upon the market. This latter phase of commercial organization is one which is now eliciting much discussion, yet one which receives less attention from growers than it deserves. But fruit exchanges are appearing in all parts of the country, and are doing much to perfect methods of marketing and transporting produce. Growers of particular fruits in special regions find such exchanges a necessity in the increasing competition of business. Cultivators are at last beginning to understand that the sale of the products of the soil is governed by the same laws of supply and demand which control business in other directions. The Florida orange growers in particular have been alert during the past year in considering methods of disposing of the increasing supply, and their efforts will be watched with interest by all horticulturists. It is asserted that only one orange tree in fifty in Florida is yet bearing profitable crops. When the remaining

trees come into bearing, very perfect methods of distributing the product must be devised, particularly as the California groves are placing large quantities upon the market. The Florida Fruit Exchange decided that all oranges should be sold at auction this year, rather than by the customary commission method. All sales are to be made in Jacksonville, New York, Boston, Philadelphia, Baltimore, Chicago, Cincinnati, St. Louis and New Orleans. This means that shipments are to be consigned to a few points, rather than scattered over the country as heretofore. The exchange has probably handled two-thirds of the Florida crop this year.

A "Florida Orange Combine" was formed in New York early in September, to which "all responsible and reputable houses in the trade shall be eligible," all "Florida orange growers to be admitted free of any dues." The object sought by this association has been a subject of considerable discussion, and an excerpt from the constitution is therefore inserted: "The object of this association shall be to prevent consignments of Florida oranges, by concentration of the same at some central point or points, viz.: Jacksonville or Cainsville, or wherever it may be found most practicable to do so, and we hereby pledge ourselves to establish a buyer in Florida at such point and buy all the oranges our section may demand, in honest rivalry with other sections of the United States, thus fixing a uniform price for all grades throughout the trade. While we pledge ourselves to buy, in Florida, along with others, that portion of the crop which will supply our section, we expect the Florida grower to cease consignment of his fruit, unless the same is consigned to a member of this organization, as it is apparent to any fair-minded man that one could not safely purchase and sell against commission fruit. We, therefore, pledge ourselves not to buy fruit of any man or set of men engaged in consigning any portion of his or their crop, except as stated above. This association will establish a uniform grade, and at all times get the best possible information for the use of growers on picking, carrying and packing, and improve the transportation in every possible way by inducing the different lines to use the most improved cars, and when possible put on special orange trains running on fast time, and provide a uniform system of marketing the entire crop by auction, and in every way make the interest of the

grower identical with our own. This shall in no way affect any arrangements previously made between members and growers.”

The orange industry is increasing with great rapidity in North America. Florida and California are the leading competitors at present, but it appears as if Mexico will soon produce large and fine crops. The emigration to Mexico of thrifty Americans has been large during the past few years, and it is from this population that we are to expect greatest importations.

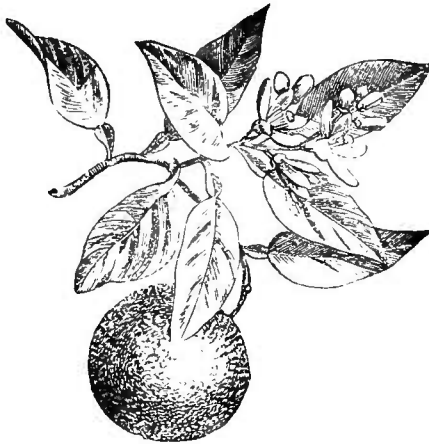

CHAPTER II.

FRUIT INTERESTS.

1. Trees and Shrubs for the Cold North.

§ I. FOR THE PRAIRIE STATES.

There is much agitation concerning the merits of particular fruits and ornamentals for the cold prairie states, where the greatest hardiness is required. There are two lines of effort for the production of varieties suited to this region,—the importation of varieties from Russia, with a few from the northern Chinese region, and the origination of hardier sorts directly from our American stock. It is no doubt true that the ultimate progress will come as the result of both these endeavors; and the present unsettled condition of affairs must in the end be productive of good, wholly aside from matters of present varieties, as it spreads and popularizes an agitation for the common good. The mass of foreign varieties which have been thrown upon the country has led, in the present eagerness of the public mind and in the absence of comprehensive tests, to great confusion and often to premature denunciation of the whole project. In order to aid in simplifying this confusion of varieties, I have invited Professor Budd, of the Iowa Agricultural College, who is particularly conspicuous in the introduction of plants for Iowa and adjoining states, to prepare lists of the varieties which at present appear to possess greatest merit. These are plants “which are doing well over a large part of the northwest.”

Apples for Prairie States—

- Red Astrachan, 1 Coll.* This is not ordinary Red Astrachan. The tree is hardier and fruit less acid and not so highly colored.
- Noble Redstreak, 61 Dept.
 Longfield, 161 Dept., 57 M.
 Sweet Stripe, 196 Coll.
 Recumbent, 240 Coll.
 Borovinka, 245 Coll.
 Arabka, 257 Coll., 155 M.
 Winter Stripe, 260 Coll., 33 M.
 Rosy Aport, 269 Dept.
 Lead, 277 Coll., 3 and 92 M., 40 Fischer.
 Veronesh Reinette, 282 Dept.
 Switzer, 304 Dept.
 Red Queen, 316 Dept.
 Yellow Transparent, 334 Dept.
 Thaler, 342 Dept., 147 M.
 Kibernal, 378 Dept.
 Repka Malenka, 418 Dept.
 Cross, 413 Coll.
 Lubsk Reinette, 444 Coll.
 Kiev Reinette, 447 Coll.
 Beautiful Arcad, 453 Dept.
 Repka Kislaja, 466 Dept.
 Zusoff's Winter, 585 Dept.
 Romna, 599 Dept., 11 M.
 Golden White.
 Plikanoff, 980 Dept.
 Veronesh Red, 1277 Coll. Has proved a fine winter apple in Southern Iowa.
 Ostrokoff's Glass, 4 M.
 Royal Table, 5 M.
- English Borovinka, 9 M.
 Blushed Calville, 22 M.
 Skisch Apple, 15 M.
 Ukraine, 10 M.
 Large Anis, 27 M.
 Repka Aport, 137 M.
 Kursk Reinette, 20 M.
 Birth, 161 M.
 Skrisch Sweet, 8 M.
 Sandy Glass, 24 M.
 Marmalade, 144 M.
 Silken, 75 and 104 M.
 Gravensteiner, 135 M.
 Breskovka, 152 M.
 Aport, 23 M.
 Grandmother, 6 M.
 Vargul, 16 M.
 Vargulek, 12 M., 55 Fischer.
 Good Peasant, 31 M.
 Karabovka, 21 M., 14 Fischer.
 Green Sweet, 2 Fischer.
 Antonovka, 8 Fischer.
 Autumn Aport, 41 Fischer.
 Golden Reinette, 51 Fischer.
 Blackwood, 58 Fischer.
 Rosovka, 52 Fischer.
 Veronesh Arabka, 94 Fischer.
 Winter Citron.
 Bogdanoff.
 Crimea (Bogdanoff).
 Shepherd.
 Persian (Bogdanoff).
 Steklianka (Bogdanoff).
 Zweibel Borsdorf.
 Boiken.

Pears for Prairie States—

- Bessemianka.
 Limber Twig.
 Gakovska.
 Autumn Bergamot.
 Kurskaya.
 Victorina.
 Early Bergamot
- Flat Bergamot.
 Winter Pear.
 Medviedevka.
 Orel.
 Dula.
 Saccharine.
 Lemon.

*Notes are here made upon two importations from Russia, one an importation made in 1878 by the Iowa Agricultural College, designated by *Coll.*, the other the Department of Agriculture importation of 1870, recorded in the above as *Dept. M.* refers to introductions from Moscow. The Fischer numbers were obtained from Veronesh, Russia.

Plums for Prairie States—

White Otschakoff.	Black Prune.
Yellow, 43 Fischer.	Early Red.
Yellow Aubert.	Hungary.
Red Aubert.	Moldavka.

All the above plums are of foreign origin. Concerning the native plums, Professor Budd writes as follows in the *Prairie Farmer* of Nov. 23d, giving also some notes on foreign varieties:

"The recent trying winters and summers have given us much valuable experience with the plum. Of the native varieties of the Americana species, De Soto, Wolf, Cheney, Rollingstone and Wyant have given the best satisfaction of those long on trial. All of these have proved regular and bountiful bearers of really good fruit, and the curculio rarely thins the crop of perfect specimens below the profitable standpoint. In size and quality the De Soto, Wyant and Cheney we place in the front list. For dessert use the Wyant is a fair substitute for the peach, when used uncooked with cream and sugar, with the pit and skin removed.

"Of the Chickasaw species, the Maquoketa, Forest Rose, and Pottawatomie have proved hardiest in tree, the most regular in bearing, and the best in quality. Of the native plums cooked at the station, last season, these were pronounced better than any of the Americana varieties, by a majority of testers.

"Of the European species the variety long cultivated in this country that has stood best, and borne the most regular crops of good fruit, is the Richland, which is now receiving much attention in parts of Indiana, Illinois and Iowa.

"Of the varieties first introduced by the Iowa Agricultural College from East Europe, the Early Red, Black Prune, Moldavka, Hungarian, Yellow Aubert, and White Otschakoff, have been most favorably reported. Of this list, the Early Red, Moldavka and Yellow Aubert have been most widely fruited, and as yet have been most favorably reported over a great part of the prairie states, and east of the Atlantic.

"Such varieties as Green Gage, McLaughlin, Lawrence, Jefferson, Imperial Gage, Prince's Yellow Gage, Smith's Orleans, Reine Claude Bavay, Bradshaw, and others, are found to be tender in tree, imperfect in foliage, tender in fruit-bud, and worthless for general planting, or even trial by amateurs in the northwest."

Cherries for Southern Iowa—

Abbesse de Oignies.	Gros Gobet.
Red Oranien.	Red Muscateller.
Amarelle Bunt.	Double Glass.
Duchesse de Angoulême.	Vilne Sweet.

Cherries for Central and Northern Iowa—

Spate Amarelle.	Gros Lang Loth.
Schattan Amarelle.	King's Amarelle.

Cherries for Central and Northern Iowa—(continued.)

Amarelle Bouquet.	Lithaur Weichsel.
Ostheim.	Griotte du Nord.
Shubianca.	Juniat Amarelle.
Doppelte Natte.	Heart-shaped Weichsel.
Griotte Imperial.	George Glass.
Brusseler Braune.	Orel.
Lutovka.	23 Orel.
Bessarabian.	24 Orel.
Sklanka.	25 Orel.
Fraendorfer Weichsel.	26 Orel.
Straus Weichsel.	27 Orel.

Peaches—

Some of the Chinese varieties have fruited and they are very promising.

Apricot—

The Shense (Acme of Nebraska), from Northern China, is the best.

Ornamentals—

<i>Populus Bolleana.</i>	<i>Viburnum Lantana.</i>
<i>Salix laurifolia.</i>	<i>Philadelphus scabra.</i>
<i>S. Babylonica</i> , from Central Russia.	<i>Berberis Amurensis.</i>
<i>S. Napoleonis.</i>	<i>Prunus triloba.</i>
<i>S. aurea.</i>	<i>Rosa rugosa.</i>
<i>Shepherdia argentea</i> , native.	<i>Spiræas</i> , particularly <i>triloba</i> , <i>Van</i>
<i>Eleagnus angustifolia.</i>	<i>Houttei</i> , <i>Douglasii</i> and <i>Nobleana.</i>
<i>Eleagnus macrophylla.</i>	<i>Tamarix Amurensis.</i>
<i>Betula alba.</i>	<i>Hydrangea paniculata.</i>
<i>Alnus incana</i> , native.	<i>Ligustrum vulgare</i> , from Poland and
<i>Hippophæ angustifolia.</i>	Central Russia.
<i>Halimodendron argenteum.</i>	<i>Lonicera Tartarica.</i>

§ 2. FOR THE NORTHEAST.

There are considerable areas in the northern portions of our eastern states where horticulture would thrive but for the extreme winters, and the remark will apply to large parts of Ontario, Quebec and other eastern provinces. In these regions, the western agitation concerning iron-clads has particular value; yet humidity of atmosphere, soil and other conditions, are so different in the two regions that each section must in a large measure discover methods and varieties for itself. Mr. Charles Gibb, of Quebec, and Dr. T. H. Hoskins, of Northern Vermont, are known as the leading promoters of a better horticulture in the cold

regions of the St. Lawrence basin. Dr. Hoskins makes the following list, for this occasion, of the fruits which have proved most reliable for the region of Lake Memphremagog :

Apples—

Yellow Transparent.	Alexander.
Peach of Montreal.	Antonovka.
Tetofsky.	McIntosh Red.
Oldenburgh.	Longfield.
Shiawassee.	Scott's Winter.
Wealthy.	Bethel of Vermont.

Pears—

None yet except the Bessemianka. Probably several other Russians will prove valuable.

Cherries—

Griotte du Nord.	Ostheim Weichsel, and probably a
Brown Brussels.	dozen more kinds from North Ger-
	many and Russia.

Plums—

Moore's Arctic.
August Red, and probably other Russians.

Grape growing is practiced to a large extent in some parts of our northern borders. Dr. Hoskins makes the following statements concerning this grape industry :

"Very few of the fruit growers in the Middle States are aware of the progress of grape growing in Canada and along our northern border, in New York and New England. There are some favored localities along the border—as Mr. Jack's, Chateauguay Basin, P. Q.,—where even the Concord and the Niagara prove a commercial success ; but as a rule, the Concord is too late, and even the Worden is uncertain. I have been growing grapes on Lake Memphremagog for now nearly 25 years with success, yet the locality is not so favorable as on Lake Champlain and the St. Lawrence river. Even on the Ottawa, grape culture is proving pecuniarily profitable. There is nothing whatever in the way of this crop except the shortness of the season, and as we are getting earlier varieties constantly, this is not insuperable. The Talman is sure in the worst seasons, and though too poor, yet it finds a ready sale at a fair price. The Delaware, Adirondac, Moore's Early, Brighton, Salem, Hartford, Eumelan and Israella, all succeed well, and the new Green Mountain seems likely to prove a first-rate early white grape. It does not appear improbable, in view of these facts, that lower Canada and northern New England shall eventually be able to supply its own markets with a sufficiency of home-grown grapes."

2. *The Newer Fruits of the South.*

§ I. NOTES ON NEW SOUTHERN FRUITS, WITH PARTICULAR REFERENCE TO SOUTHERN FLORIDA. BY E. N. REASONER, MANATEE, FLORIDA.

Angel Peach. Originated near Waldo, Florida. It is a seedling of the Peen-to, retaining all the vigor and productiveness of its parent. It is a perfect freestone, very early, and has a delicious, rich sub-acid flavor. It will be extensively planted in Northern Florida and Southern Georgia, in place of Peen-to, as its habit of blooming somewhat later than the latter places it out of reach of late frosts; and it has a better appearance and flavor than the parent.

Chinese Blood Peach. A very fine blood clingstone of vigorous growth, and blooms late in the spring; recently introduced from Japan and promises to be very valuable; fruit large, blood red; clingstone; ripens early in July.

Japan Dwarf Blood Peach. A stocky, rather dwarf growing peach from Japan. Of good size and appearance; freestone; ripens in June; has fruited finely in Southern Louisiana and promises well for a market peach.

Maggie Peach. Originated in North Florida. Size medium to large; appearance excellent; slightly oblong; color yellowish white with flashes of red; flesh fine, melting and juicy; ripens first of May. Has been already extensively planted.

Red Ceylon Peach. Originated at Fruitland Park, Florida, from seeds received from Ceylon. Will probably do well in extreme Southern Florida. A freestone of excellent quality; flesh yellow, blood red near the pit, and of an agreeable acid flavor, but not sour. This will prove the best for canning or drying. It ripens early, and the fruit has no trace of *noyveau* flavor.

Reeves' Mammoth Peach. Originated in Orange county, Florida, from a Florida seedling. A freestone, ripening during July and August; nearly round; flesh white, well colored at pit; seed small as compared with size of fruit, which is very large, some specimens weighing a half pound. Quality good, sprightly and high flavored.

Yum Yum Peach. A seedling from Peen-to, coming from Waldo, Florida. Ripens very early, before or with the parent

Peen-to. It is of medium size, slightly long in shape, having a small suture, and short recurved point. In color it is a rich wax, or cream, slightly tinged with red on one side; juicy, of most delicious flavor, being free from the *noyeau* found in the Peen-to, and parts fairly well from the seed. The tree is a vigorous grower and heavy bearer. This is being largely planted.

White Adriatic Fig. This was introduced into the extreme south scarcely four years ago and has proved its adaptability to the various soils and climate of the Gulf coast. In Southern Florida, where the tropical rainy season is felt the most, the fruit cannot profitably be grown for drying, but above this section the tree promises well for either drying or shipping to market in a fresh state, in much the same way as strawberries.

San Pedro fig, with all its good recommendations from California, has not yet done at all as well in Florida as the former. The tree grows thriftily, but when half grown the young figs drop. As yet no cause can be found for this unfortunate habit.

Ference fig has grown well for two seasons, but has not yet fruited to any amount. It is said to be excellent for drying.

Oriental plums are all doing remarkably well over the whole south. In extreme Southern Florida only isolated specimens amount to anything, and these have extra care and attention. Although of such undoubted merit, the Kelsey does not bring remunerative prices, as it is shipped during the summer months when other plums and choice fruits are in abundance farther north.

In oranges there are some improvements. Rev. Lyman Phelps, of Sanford, Florida, has, by crossing originated a new one called the "Jaffa Blood." This was produced by direct pollination, and the result is a terminal bud sport from the Jaffa orange. Mr. E. H. Hart, Federal Point, Florida, has grown Villa Franca lemon with the characters of the Navel orange. By simply inserting buds of a Navel in the forks of a lemon tree, direct pollination was secured, and resulted in lemons having navels, with the shape of the orange. Of course this is only a curiosity, but it serves to illustrate what may be done in pollination of citrus fruits.

Musa paradisiaca variegata has fruited; the fruit resembles

closely the ordinary plantain, but is striped lengthwise with white. We find the Large Fig banana a most excellent sort. In flavor it is between a Hart's Choice and Dwarf (Cavendish), but more closely resembles the latter. The plant is very prolific and fruits as quickly after planting as does Hart's Choice. *Musa Ensete*, the ornamental banana, does not succeed in Southern Florida. The soil is too thin and light. It needs rank manuring and plenty of water.

Psidium Guineense, the Guinea guava, has fruited for the first time in Florida. The fruit is pear-shaped, with a very rich flavor; a novice with guavas would not eat many. The Cattley guava and the Chinese or Yellow guava still continue popular. They will grow in any soil, and while growing vigorously, bear enormously. The fruit does not make as good jelly nor as much of it, as varieties of our common guava (*P. guaiava*), and many are disappointed in this respect. It can, however, be canned and preserved in other ways, being excellent when cooked.

Solanum Guatemalense, the widely advertised melon-pear or melon-shrub, produces well when manured heavily and watered excessively.

A new pomegranate called "Purple-seeded" is advertised from Northern Florida. The proprietor advances many good qualities for it. It is not disseminated widely yet, even for trial. The introduced varieties from California—Paper-shell, Hermosillo and Spanish Ruby—have been planted considerably along the Gulf, but no mention of them is made in the horticultural papers. The fruit of each sort is exceedingly delicious and trees bear well if properly cared for.

The kaki or Japan persimmon finds greater favor every year, and much credit is due Mr. Van Deman for his painstaking care in assorting the many names and bringing order out of chaos. The growers responded liberally in sending specimens of fruit to him for examination and comparison, and soon we may see advertised strictly correctly named trees.

The olive is coming rapidly into demand. Young trees of a variety of sorts, but chiefly Picholine, are bearing in various places. The soil and climate are suited for this tree over the greater portion of Florida and the region bordering closely on the Gulf westward.

LeConte and Keiffer pears are growing and bearing in the

Lake region of Florida. There is reported blight on the LeConte in Southern Georgia, but nothing definite is known about it yet.

Niagara grapes are being almost exclusively planted in place of others this year. The success of this grape in Orlando, especially, has created a widespread interest over the rest of Southern Florida. Other grapes of better quality even are not being planted except by the "careful few." Whether the Niagara business will be overdone is a mooted question.

Much has been said and written about fibre plants this year and Sisal hemp in particular, but no one has taken hold of the industry on a commercial scale as yet. There is no reason why Florida cannot produce at least a part of the cordage necessary for use in the United States, and at a good profit.

The casava (*Manihot aipi*) is now cultivated extensively over the south. This produces immense crops of roots which are available as food for man and for all our domestic animals. Propagation is carried on by cutting up ripened stalks in the way sugar cane is planted. These are kept over winter in a dry situation, or "hilled" up in dry sand.

Jamaica Indian sorrel (*Hibiscus Sabdariffa*) is now planted commonly over Southern Florida. This forms large bushes, sometimes ten feet high, with a blossom at every leaf. The red fleshy calyx is stewed, and tastes very like cranberries. A fine jelly is made also. The Roselle hemp is obtained from the branches by decortication.

The McNeill pea, a cow-pea of recent origin, is attracting attention in Northern Florida. It is very prolific, and first rate for the table, besides furnishing heavy feed for stock.

Pennisetum sp. from India, a fodder grass of the greatest vigor, since its introduction to Florida has grown remarkably. The seeds sown in May produce rich grass which can be cut when two and a-half feet high four or five times by the last of October. If the seed is left uncut on the grass till dead-ripe, enough falls off to seed the ground for next season. This is adapted to dry soils and is superior to anything yet tried.

§ 2. NOTES ON FLORIDA PEACHES. BY G. L. TABER, GLEN ST. MARY, FLORIDA.

Amongst the new fruits adapted to the south I know of nothing that promises better than the Angel Peach, which I have first placed upon the market for this winter's trade. My attention was first called to this peach a little over one year ago, and after investigating its merits I promptly bought the original orchard tree, paying a large sum for it. The Angel is a seedling from the Peen-to, originated near Waldo, in this state, and retains all the vigor, productiveness and adaptability of the parent Peen-to. Some of the important characteristics of this valuable variety are as follows, viz :

First. The Angel is an early peach, and a perfect freestone.

Second. It is of perfect shape—almost exactly round.

Third. It is a very large peach, of high color, and exceedingly handsome.

Fourth. It comes into bearing very early, and is exceedingly prolific.

Fifth. It is entirely devoid of the *noyveau* flavor, characteristic of the Peen-to and some of its seedlings. The flesh is white, melting and juicy; a delicious, rich, sub-acid of exquisite flavor.

Sixth. The Angel blooms a full month later than the Peen-to, thus avoiding frosts that would prove destructive to the Peen-to and admitting of the Angel being grown much farther north than that variety; at the same time there is no question as to its equal adaptability to the extreme south, with either the Peen-to itself or any other of its numerous seedlings.

During the past seven years I have tested upward of one hundred and twenty-five varieties of peaches in my own orchards and have made several introductions of new varieties of unusual merit for the extreme south. I am offering several new varieties this year in addition to the Angel but consider this variety the best of any of the new introductions. Two other varieties are, however, worthy of special notice, viz : The Laura, a very large, round, early clingstone which originated from the Peen-to, and the Imperial, a large, oblong, early freestone which originated from the Honey.

I am also offering, for the first time, the new apri-

cot Santa Fe, which originated on the shore of Lake Santa Fe in this state, and from which it is named. It is a remarkably early variety, ripening the last of May, and for the past five years the original tree has not missed a crop, while the majority of the varieties of apricots are extremely uncertain in this state. The Santa Fe is a very fine variety and its reliability makes it doubly valuable here.

3. Tendencies in California Horticulture.

One of the most remarkable developments of American horticulture in the last few years has been the growth of the dried and canned fruit industries of California. California horticulture is developing in every direction with wonderful rapidity, and it is difficult to signalize any branch of it for particular discussion in an annals of current progress; yet its most conspicuous feature at the present time appears to be the tendency and determination to drive all foreign preserved fruit products from American markets. This has been most marked in raisins. The raisin output has increased from 6,000 20-pound boxes in 1873 to 915,000 boxes in 1888. The products have met with good demand in the east, and they are even now finding lucrative markets in the old world. So brisk has been the competition, that Spanish or Malaga raisins are each year decreasing in quantity in our markets. In 1882 nearly 1,000,000 boxes of Malaga raisins, out of a total crop of 1,900,000 boxes, were marketed in the United States, while in 1888, only 112,000 boxes, out of a total crop of 700,000 boxes, came to this country. The United States Consul at Malaga hears a prediction in Malaga itself that California raisins will soon largely supply the markets of Spain! It is certainly evident that American markets will soon be supplied entirely with the American product. It is said that the advantage of California raisins over Spanish is that they do not "candy" so soon, and can be kept longer.

Prunes from California are competing sharply for control of American markets. Fig culture is also attracting great attention, and dates are among the possibilities. The following comprehensive report upon figs by a committee of the California State Horticultural Society presents the latest and best compendium of the fig industry:

Your committee* on "The Fig," after devoting considerable time and labor to carefully examining very many varieties grown and cured in this State, and comparing them with the imported Smyrna, or "Fig of Commerce," respectfully report that we have arrived at the following conclusions:

First—That the true type Smyrna fig, the variety known as the "Fig of Commerce," as imported and sold in the markets of this country, has not been produced, so far as this committee could discover, in this State up to the present time.

Second—That the different fig trees growing in this State, known and designated as the true Smyrna, have not thus far produced the true type Smyrna or "Fig of Commerce."

Third—That all of these varieties, including the White Adriatic, are producing fruit valuable for drying and are worthy the attention of all who desire to grow figs, either for profit or pleasure.

Fourth—That the foothill regions of the State are especially adapted to the growing of figs and produce the finest qualities, and these uplands are, in our judgment, preferable to the lowlands of our interior valleys for successful fig culture.

Fifth—That growers of figs in California are impatient and expect too much of their trees. The Smyrna fig tree does not produce and mature its true type fruit until the eighth or tenth year from planting, even at Smyrna, the home of the fig. Why should we reasonably expect better results in California? But some California growers do expect most extraordinary results from very young, scattered fig trees. They expect an abundant crop of mature figs from three or four-year-old trees, and stand ready to condemn the trees if such results are not realized.

CURING, PREPARING AND PACKING THE FIG FOR MARKET.—This committee, after a careful investigation, further find and are prepared to say that very many changes from present methods are desirable, and that there is a chance for great improvement. Under this head, we will subdivide as follows:

First—The fig should be allowed to thoroughly mature and ripen upon the tree before it is gathered. By this we do not mean to be understood that the fig should be over-ripe.

Second—That the fig may be improved by bleaching, but that at present our growers sulphur entirely too long. Six to eight hours in the sulphur box will ruin any fruit, particularly the delicate fig, as it destroys the flavor, bleaches the pulp and flowers of the fruit and renders it tasteless and practically worthless for market. The time required to arrest fermentation and prevent oxidization is from ten to thirty minutes, varying as to conditions and circumstances.

Third—Figs should be thoroughly sweated in bulk after drying, care being exercised not to dry them too much, and after thorough evaporation and sweating, they should be dipped in clear, scalding water before packing. The sweating process will equalize and soften the fig and prevent it from turning sour after being packed.

Fourth—The figs should be graded, both as to size and quality, into three uniform sizes, Nos. 1, 2 and 3. Grades Nos. 1 and 2 should be more or less handled and then packed in layers in boxes of convenient size. Grade No. 3, being the small, poor figs, should be packed in canvas bags holding about sixty pounds.

*B. N. Rowley, G. P. Rixford, Alfred T. Perkins.

4. *Oriental Fruits.*

It has long been known that the ornamental plants of Japan and some parts of China are peculiarly well adapted to the soil and climate of the Atlantic States. In fact, the floras of those countries are in many respects remarkably similar to that of our Alleghany region. The nature of these similarities and the reasons for them were long ago presented in a striking generalization by Asa Gray. Our Pacific coast flora has fewer affinities with our eastern flora than the eastern has with the Japanese. We should expect that our eastern pomology must derive many acquisitions from Japan and northern China, and such is notably the case, particularly if we consider the very recent period in which the most important introductions have been made. Yet the kinds are fewer and less various than we are led to expect from our experience with oriental ornamentals. Comparatively few of them are adapted to the Northern states, and such as are hardy are little known: *Prunus Simoni* is hardy even in Canada and Iowa; certain Chinese peaches and apricots give promise in the north; offspring of the Japanese or Chinese pears possess more or less value in the northern and central states, and the northern limits of profitable culture of the Japanese plums are not determined. Mr. Charles Gibb, of the province of Quebec, well known through his knowledge of fruits in the extreme north, is now traveling in Asia with the hope of finding, particularly in Mandchuria, fruits of great hardiness. We shall at least hope to learn how much we are to expect from these countries. In the meantime, it may be useful to make an inventory of our fruits of oriental origin.

To southern horticulture, several of the Japanese and Chinese fruits have already come to be of commercial value. The Japanese persimmon, or Kaki (*Diospyros Kaki*), is probably the most important. "Nine fruiting seasons just passed," writes Mr. Berckmans, "have satisfactorily settled the question as to the value of this fruit for the cotton-growing belt of the southern states, where the tree is perfectly hardy. The merits of this fruit are the early bearing age of the trees, as well as wonderful fertility, as it is quite common to see one-year-old trees planted in spring produce a crop of from twenty to fifty well-developed persimmons the following

year." The nomenclature of the varieties is much confused, but there are, probably, no more than a dozen clearly marked sorts. The fruit is now beginning to be known on the markets. *Garden and Forest* makes the following interesting notes upon this beautiful fruit:

"The fruit of the Japanese persimmon, or Kaki, can still be found [early December, 1889] in the markets of New York in great abundance, and of extraordinary beauty and excellence. It is raised in Florida and Georgia, where the Kaki has been planted in large quantities. It is by far the handsomest dessert fruit which the market affords at this season of the year; but it is a question whether the Kaki really possesses as good a flavor as one of our thoroughly ripened and frosted native persimmons from Georgia or Virginia, a fruit which some people consider about the best that grows. A cross between the American and Japanese species might be expected to produce a fruit of larger size and finer color than that of the former, and with a richer flavor than any of the cultivated forms of Kaki. The Asiatic persimmon, according to Rein, is 'undeniably the most widely distributed, most important and most beautiful fruit tree in Japan, Corea and northern China. In Japan it endures night frosts at a temperature of from twelve to sixteen degrees C. It can be cultivated high up in the valleys and far beyond the limit of the Bamboo cane. It is a stately tree, after the fashion of a pear tree, with beautiful deciduous leaves, almost as large as those of some magnolias, but of bright green color and resembling those of the pear in shape only. The new leaves come in May; it blossoms in June; the season of ripe fruit is late in autumn, from the middle of September until the end of November. There are many kinds of Kaki, ranking in size from a small hen's egg to a big apple. Some are nearly spherical, others oblong, others heart-shaped. In color of the outer skin they run from light orange-yellow to deep orange-red. They are distinguished also by their taste, which is pleasant in its way and reminds one of tomatoes, as does the color also. They are eaten not only in a soft doughy condition, in which those of the Migako-no-djo, in the province of Hiuga, are prized most highly, but the fruit is gathered while still hard, to ripen afterward. The best in Japanese estimation are *Tarugaki*, that is, tub persimmons, which have been converted from astringent into sweet fruit by being kept in an old saké tub. The bitter astringent taste of all green Kaki remains, even in the ripe fruit, in the case of most varieties, and it is from these that, during the summer, an astringent fluid, rich in tannin, is prepared (called Shibu), an acid of considerable importance in several industries.' When over-ripe and dried in the sun, pressed somewhat flat, and then put away in boxes, the sweet Kaki get to look and taste, in a few months, when skinned, like dried figs, and are used like them. The white powder which covers these dried persimmons in boxes is natural sugar that has exuded from the fruit. 'In September the Kaki tree, laden with large, orange-colored fruit, is a great ornament to the landscape. This beauty it preserves till it loses its leaves in October.'"

Several Chinese peaches are widely distributed in the south and are valuable. The best known of these is the Honey, which originated so long ago as 1854. It was raised by Charles Downing from a pit from China, and was dis-

tributed by Mr. Berckmans in 1858. Peen-to (*Prunus platycarpa*) peach originated with Mr. Berckmans in 1869 from pits sent from Australia, where it was probably introduced from China. Seedlings of these peaches are among the leading fruits of the south. There have been recent introductions of a different race of Chinese peaches, which appear to be adapted to the very northernmost borders of our present peach districts. In 1881 the Iowa Agricultural College imported eleven varieties from the "hill country northwest of Peking. They have larger, thicker leaves than our common sorts, ripen their wood earlier in fall, and have proved thirty per cent. hardier than our old sorts."

An apricot from northwestern China also gives promise in the north.

The apricot plum (*Prunus Simoni*) was introduced into this country, by way of France, probably less than ten years ago. It is cultivated mostly as a curiosity, yet it possesses several points of excellence as a market fruit. It is hardy even in Iowa. Improved varieties will undoubtedly soon appear.

Several varieties of Japanese plums (*Prunus Hattai*) are now well distributed in this country. The first introduction appears to have been made into California in 1870*, the variety being the one now commonly planted as Kelsey. The Japanese plums are fruits of large size and great beauty, and Mr. Berckmans thinks that "for our southern states they open a new era in plum culture." The varieties are confused, but they are at present probably less than a dozen.

The Chinese or Sand pear (*Pyrus Sinensis*) was perhaps the first fruit introduced into the United States from China or Japan. The Sand pear possesses no commercial value, but some of its seedlings are widely grown. The leading ones are the Kieffer and LeConte. It is supposed that most of the American offspring of the China Sand pear are hybrids with our common pear, but these statements need verification. The quality of the Chinese and Japanese pears, and their seedlings, is poor, but the fruit appears to be particularly adapted to large areas of our country. About a dozen varieties are now grown in America.

*1871 is commonly given as the date of introduction of the Kelsey. Mr. Wickson makes the following record: "Trees brought from Japan by the late Mr. Hough, of Vacaville, in 1870, and purchased by the late John Kelsey, of Berkeley, who propagated and fruited them for several years. First wide distribution was made by W. P. Hammon & Co., in 1884, who named the fruit after Mr. Kelsey."—*California Fruits*, 346.

A score or more of Japanese oranges are now cultivated in this country. One of the first introductions, or perhaps the first, was the Satsuma Mandarin, which has brought to Florida in 1876. Much may be expected of the oriental oranges in this country, when further introductions and adaptations have been made. They mostly represent a distinct and peculiar type. Professor Georgeson describes them as follows:

“The Japanese oranges are as different from our idea of an orange as they can well be, separating from the peel almost as easily as a grape, dividing into sections at the slightest pull, each section like a separate fruit, each piece dissolving in your mouth with the flavor of cherries, leaving no pulp behind.”

Other oriental fruits which are now grown in America are the following: Japanese chestnut, Chinese walnut, kumquat (*Citrus Japonica*), loquat (*Eriobotrya Japonica*), hovenia (*Hovenia dulcis*), a jujube (*Zizyphus Jujuba*), litchi (*Nephalium Litchi*), and a myrica (*Myrica rubra*). The last was introduced during 1889 by H. H. Berger & Co., of San Francisco. A recent number of the *Pacific Rural Press* describes it as follows:

“*Myrica rubra*, Sieb. & Zucc.—This evergreen fruit-bearing tree, indigenous to Japan, has only lately attracted the attention of botanists. It is a native of the southern parts of Japan, attains a height of forty to fifty feet, and a diameter of two and one-half to three feet. The foliage, resembles the magnolias and is of a firm leathery texture. The fruit blossom appears early in spring, and the fruit ripens during the month of July. It resembles in shape a firm blackberry, an inch long by three-fourths of an inch in diameter. It contains a single seed-stone of light weight. There are two varieties of this fruit. The one is a dark red, almost black, the other a light rose which is superior in flavor to the dark. The fruit is highly flavored, vinous and sweet, and answers all purposes to which our blackberry is put. It is delicious as a dessert fruit, makes a fine preserve, jelly or jam. The juice extracted from it may be taken as a refreshing beverage in its fresh state, and after being allowed to ferment produces a fine wine; set with alcohol, a brandy is gained from it equal to our famous blackberry brandy. The tree itself is highly ornamental, the bark is useful for dyeing a fawn color, and the timber is used in Japan for the most elegant cabinet-ware, having a finer mottled grain than the bird's-eye maple. The wood is light, tough and very durable. The tree is perfectly hardy in all latitudes where the thermometer will not fall below 15° above zero. It would succeed admirably throughout California, Texas, Mexico and all the southern states of the Union. The propagation of this useful tree is best carried on from seed, to which it comes true, or by grafting scions from a fruit-bearing tree on seedlings, which thus will come in bearing in a couple of years. The seed ought to be sown in leaf-mold and loamy soil with bottom heat if obtainable. The same ought to be kept

well shaded and mulched. The natives of the Japan provinces where this tree forms small forests say that the seed best germinates when, having been eaten by birds, it is passed through in the excrements into soft leaf-mold in shady places, when it germinates in a few days ; or, if the seeds have by accident been thrown into a rubbish heap of soil and other vegetable matter, on being cleaned away say after a month's time, the seeds are found well sprouted among the waste. The seed is light and ripens during July and August."

CHAPTER III

ORNAMENTALS.

I Recent Tendencies in Ornamental Gardening and in Ornamentals.

§ I. EVOLUTION IN TASTE.

The last year or two has witnessed a gratifying tendency in ornamental gardening to return to old species and to single flowered varieties. For many years the monstrous double flowers and horticultural curiosities have eclipsed simpler plants. It has seemed as if the freaks of fashion were determined to draw the gardener away from nature into a curiosity shop of monstrous forms and intense colors. This desire for abnormal forms of plants no doubt had its inception in the offering of striking varieties by dealers, but the desire appears to have outrun the means of its gratification and to have demanded impossibilities of the agents which gave it birth. The result has been that seedsmen and plantsmen have exercised every ingenuity to satisfy the public demand. Like all mere fashion, however, this love of novelty and monstrosity must reach a time when it shall sink into the purer and more permanent love of simplicity in nature. It is not necessary that all monstrosity and curiosity in plant variation should be discarded, but it is a rule which every person of artistic taste must hold that the abnormal and unusual shall never rival the normal or natural. The two characters hold the relation of spice and nutriment. There is at the present time a prominent reaction in favor of the older herbaceous perennials and a steadily growing desire for native plants. This "renaissance of herbaceous perennials," as Edward Lincoln happily char-

acterizes the movement, brings back to our gardens the endearments of long associations and carries us towards the love of nature rather than the admiration of the conservatory.

The most prominent phase of conventionalism in ornamentation, however, finds expression in carpet-bedding. So intense has become the praise of gaudiness and mass in color that carpet-bedding has even become confounded with landscape gardening, and it very often receives that appellation. Landscape gardeners have planted themselves firmly against the current, but they have for the most part acquired unpopularity for their pains. A most powerful invective has lately been hurled at this consuming fashion by William McMillan, of the Buffalo parks. Indeed, Mr. McMillan's essay carries so much of the gist of an appreciation of nature and at the same time exposes so much of the grossness of the fashion, that it deserves the first place in our horticultural literature of the year. This paper was presented before the Society of American Florists, and has been published in some of the periodicals; and everywhere it has aroused discussion. It is the utterance of a taste which is near to nature and which can interpret her. It may be above the average or even the frequent conception of beauty, but its standard is unassailable and immutable. "On a warm summer day, when a gentle breeze fans the foliage of the birch or poplar, the rythmical whispering and dancing motion of the leaves, will, to a lover of these trees, hum sweet music in his ear, and reveal a beauty not heard or seen by other people."

§ 2. GENERAL NOTES OF ORNAMENTALS. BY F. L. TEMPLE,
CAMBRIDGE, MASS.

To give even an outline treating of the growth and development of the present passion for ornamental plants and trees, which is so marked a feature of American horticulture at this day, would require large space, but some facts are too interesting to pass over in silence, although they do not come strictly under annals of 1889.

Our early settlers were people of some culture, and brought from Europe with them the love of flowers and the habits of using them, and never lost fully this refined instinct, even when their descendants passed their lives in remote and rude sections of the eastern states. They also brought with them the few pre-

cious kinds of shrubs and plants that were the people's favorites—this always means those of extreme hardiness and vigor as well as beauty—and planted them near their rude homes, and to-day there is no more pathetic sight in New England than to see on the long-forgotten site of some early settler's cabin a great mass of the good old lilac or patch of the double soapwort, two plants which deserve to be called the "colonists' comforts."

For many years all the garden plants that were planted by the people in our new country were the "slips" of such hardy kinds, given by one friend to another, and as I can myself vouch from early recollections in a country town, they were treasured and watched with loving care till able to endure all accidents. But when the great increase in means of transportation, by express and by mail, of all sorts of articles came, this love for beautiful growing things suddenly asserted itself and sought full gratification after so long repression. Nurseries and floral establishments sprung up as if by magic, and found good support. These again stimulated the hunger for plant beauty by seeking out new and showy plants from every part of the earth. Hardy plants were at first almost the sole kinds used, but gradually the more showy tropical sorts came to be thought more ornamental, and the now waning rage for "bedding plants" had its day. After satisfying the natural curiosity for seeing new forms and colors, we are now going back to the larger use of the permanent hardy shrubs and trees, and are using the tender plants in their proper subordinate relations, where they are of great value and will always hold an honorable place. But the day when a bed of scarlet geraniums was esteemed sufficient planting for a lawn around a noble house is gone forever, and a truer taste has been developed and acknowledged by trying and comparing both these methods—that of a glare of tropic colors lasting two months and then ten months of bare ground, and that of generous and adequate massing of shrubs with rich foliage and good flowers— and this refined taste has finally settled the principles which shall regulate the treatment of our home grounds.

Besides the universal acknowledgment that now obtains among all persons of any culture on this subject, that foliage is the main thing needed to satisfy the eye and form the sub-

stantial body of all plantations for ornament, the growing use of shrubbery has had a special effect which is of great importance. It has caused us to study our rich native flora in the way of shrubs, and to make use of the many charming natives that exist so abundantly in our fields and forests. This is the most healthy and hopeful phase of the whole subject, and is proof that the real and permanent beauty is now appreciated, and that glare is at a discount.

Our land is far more rich than Europe in fine decorative native shrubs, and this is a fact that Europeans were quick to see and make use of, while we have sadly neglected them as a rule, until the present awakening of taste has demonstrated their value and caused their use in many important places. In this existing impulse of our people to decorate their homes with plants, the thoroughly trained landscape gardener has done a noble work. It is largely through his honest and often unappreciated efforts to plant as true taste requires, and what things are most natural and characteristic for the given place rather than what untrained taste sometimes suggests, that a better knowledge of the true uses of plants and trees has been taught. His object lessons have been like good seed, and now fashion—most potent of all modern causes—has caught the spirit of it, and ordains that all grounds shall be at once and properly planted. We are still in the transition state from the earlier barrenness of ornament of the average “yard” of old days through that of “bedding” glories into the final and restful method of treatment, where masses of pleasing foliage, lighted up with flowers and varied in forms, and enduring most of all the year, give a sense of rest to the tired soul, instead of an ephemeral glare of colors, succeeded by sudden ruin at first frost, eked out by a long refrain of bare ground.

In this present elastic condition of our national ways of planting, it would be useful to compare the practice of the older nations who have had longer time to study this matter. In looking at them relatively, we find that the greatest difference lies in the far larger use made of evergreen shrubs, especially broad-leaved evergreens, in Europe. They plant for the whole year; we plant for the summer. England is famous for her laurels and rhododendrons, and uses them so freely that the main difference between the appearance of a

well planted place there in summer, or in winter, is mostly in the absence of blossoms in winter. So great a part of their shrubbery is made up of such plants as rhododendrons, that it is always green as far as the general effects go. This is not quite so easy to accomplish in our hotter summers and colder winters, but still it can be done by using plentifully the few shrubs that meet all these conditions, as our native rhododendrons and kalmias do so perfectly for most sections.

Turning from the general aspects of the case to some of the details, we find that the past few years have seen the introduction of many trees and plants of great interest to all cultivators. We are still learning what use to make of them, and need a long time to find out their true values in our land, with its widely differing conditions of climate. Among the most important of these newer species, which have just come into limited use with us, is the *Syringa Japonica*, or "tree lilac." This is the only species of the lilac group that really makes a considerable tree. Its native habit is the northern portion of Japan, where it is not very abundant, except in certain locations. A full botanical description of this remarkable tree can be found in *Garden and Forest* of July, 1889, with a good photogravure illustration. Its general appearance is that of a robust upright tree with a trunk closely resembling that of a fine, smooth, Morello cherry tree. Its foliage is half as large as that of an ordinary catalpa, thick and dark green, never diseased or injured by insects. Its blooms are individually smaller than those of the common lilac, but are produced in such great masses as to make a show not equalled by any other tree.

Spikes of its white, odorless flowers two feet long and eighteen inches broad have been measured on young trees near Boston. It is not known how large this noble species will grow in this country, but already some of the first raised here have reached the height of nearly twenty feet, with a diameter of seven inches. The highest authorities on trees have expressed the opinion that this is the most ornamental and valuable tree introduced for many years. It is, like all lilacs, extremely hardy, and not particular as to soil, while its vigorous and erect habit of growth in the nursery will be a recommendation with nurserymen. It shows no disposition

to assume the bush form, but is a tree in every sense of the term, always with a single stem, and never sends up suckers from the roots. It will be prized most, perhaps, as a specimen tree on the lawn, though other uses may be found for it. I had the peculiar pleasure of raising the first seedlings of this superb tree grown in a commercial place, and of introducing it to use, and feel much pride in its steady increase of popularity.

Another species of the same beautiful family is the new weeping Chinese lilac (*Syringa ligustrina Pekinensis pendula*), a weeping form of a species from the mountains of Pekin. This sort has a habit as pendulous as that of the Kilmarnock willow, with white blossoms with the odor of honey. It is one of the most interesting of the class of weeping trees now so popular.

Syringa villosa is another species of dwarf habit with foliage like that of *Syringa Emodi*, but more showy in flower. It is probably a geographical variety of that species. It is a very charming shrub, with its low round form, large leaves and large bright rose-colored spikes of bloom.

Syringa oblata is a species closely allied to the common lilac, but with very broad heart-shaped, thick and dark foliage of most striking appearance. It has the further value of not mildewing. It is greatly admired. It will be used by landscape gardeners for massing whenever plentiful enough, as the bad habit of turning white with mildew the last half of the season spoils our common lilac for use as a shrub for large massing in parks or otherwise.

Pyrus Malus Parkmanni (or *Halleana*), the finest of all the charming double flowering Japanese crab-apples, is a small tree producing foliage much like a laurel or kalmia, and blossom buds almost exactly like those of carmine-colored tea roses and which expand into semi-double rosy carmine flowers. There is no flowering tree in cultivation in our latitude so exquisitely beautiful during its period of bloom as this hardy and easily grown "tea-rose crab."

Other new trees of first-class merits as ornaments, are *Acer sacharrinum columnare*, a sugar maple, with the habit of a Lombardy poplar; *Ginkgo biloba fastigiata*, with similar habit; *Acer sacharrinum*, "Autumn Leaves," a form of the sugar maple, which has foliage all summer of solid yellow,

with fine green pencilings at the ribs and veins, with edges shading towards white, precisely as this species colors in the autumn; *Clematis Davidiana*, a species from China, half shrubby, very strong grower, flowers blue in whorls of 10 to 20, with very sweet odor, the leaves when ripe, or when dried, emitting a strong and delightful scent of "new mown hay," and are used in bags for permanently scenting the house, or clothing chest; *Pinus strobus zebrina*, a variety of the white pine, having white bars of half an inch in breadth across the needles; *Robinia pseudacacia mimosæfolia*, a variety with very small foliage, in effect as fine as a tree fern; *Cytisus Laburnum pendulum*, a weeping form of the Scotch Laburnum, of much beauty; *Salix vitelina* var. *Britzensis*, a neat growing willow having the bark on new growth of a bright orange crimson, during winter and spring, the most effective of all willows for winter effect; *Hydrangea vestita*, a new hardy hydrangea, which forms a large bush six to seven feet high, with flat, round cymes, as large as those of Otaksa, with white blossoms, and blooming two months earlier than *Hydrangea paniculata grandiflora*, very showy.

2. *Chrysanthemums.*

§ I. BRIEF HISTORY.

The centenary of the introduction of the chrysanthemum into Europe was celebrated in England early in November. Already the most popular of flowers, this celebration has served to still further popularize the chrysanthemum, and to stimulate exhibitions in all parts of the world. A collocation of all the records of chrysanthemum culture has shown that wonderful progress has been made in varieties, that virtually in a half century a comparatively unpromising plant has given rise to variations of most unusual character and of surprising usefulness.

"It is proper to observe," writes C. Harman Payne, in the *Gardeners' Magazine*, "that when we speak of the centenary of the chrysanthemum the intention is to refer to the importation of the first of the large flowering species. Long before this event took place we possessed tolerably accurate accounts of the existence of such a flower, and it is reasonably conjectured that a small-flowering variety was in cultivation



FIG. 1. KIKU, THE ORIGINAL LARGE-FLOWERED CHRYSANTHEMUM, 1789.

in this country [England] some few years previous to the introduction of the one from which we date the uninterrupted history of this popular autumn favorite. * * * * The year 1789 is a memorable one in the history of France, and

in the annals of horticulture it is not by any means of mean importance. Up to that date the dahlia was unknown in Europe, the Moutan pæony had not been brought from China, and the chrysanthemum was still only known to the florist of the period as a decorative subject frequently employed by the Chinese artist on his tapestry and ornamental papers. During that eventful year a Monsieur Pierre Blancard, a merchant of Marseilles, introduced from China three varieties of chrysanthemums, one with white flowers, the second with violet flowers, and the third with purple. The last only was he successful in preserving, and there is no record of his ever having attempted any subsequent importations. The next year several plants of this purple-flowered chrysanthemum were sent over to England." This variety, known as the "Kiku"—which is the Japanese name for chrysanthemum—is represented, reduced, in fig. 1.

The first chrysanthemum seedlings appear to have been raised by M. Bernet, of Toulouse, France. The seeds were sown in 1826. He subsequently produced many varieties, and they attained to considerable popularity for the period. "None of these are now grown in this country," says Mr. Payne, "for they belonged to a type long since discarded by English growers, who for a long run of years refused to be content with anything short of a strictly symmetrical globular incurved flower as an exhibition subject. Some, however, of these early seedlings bore resemblance to the reflexed class, and there is good ground for believing that Christine, Temple of Solomon, and Chevelier Damage, still cultivated by lovers of that class, were the product of M. Bernet's seed-bed." About 1835 the first English seedlings appeared, and in 1836 a Jersey Island gardener began the origination of new varieties, and he obtained some 500 seedlings in a short time. This success stimulated English gardeners, and from this date numerous new sorts have appeared. The first pompon appeared in 1846.

§ 2. CHRYSANTHEMUM NOTES. BY EDWIN LONSDALE, CHESTNUT HILL, PHILADELPHIA.

Chrysanthemum culture in this country dates back but a few years. The first show held in Philadelphia, worthy of the name, took place no longer ago than 1883 or 1884; and al-

though Horticultural Hall was well filled with plants on that occasion, only one collection was what is known as "pot-grown." The balance had been grown in the open ground all summer and lifted and potted a few weeks previous to the day of opening the show. It seems hardly credible to the chrysanthemum expert of to-day, without reflection, that such rapid strides could have been made in so short a time. In all well-regulated chrysanthemum communities it would now be considered the height of absurdity to even think of growing the plants in any other way than in pots all summer for exhibition purposes.

When about twenty-five or thirty new varieties were announced by H. Waterer, as having been received from Japan in the autumn of 1883, much interest was aroused in horticultural circles. If I remember correctly, water-color paintings accompanied the consignment, and the plants were numbered. Whether the varieties were labeled carelessly or became mixed in transit will never be known, but it is certain that there were deplorable mixtures when the plants flowered the following fall. Several sets were exported to Europe, and as a consequence, great dissatisfaction resulted. The mistake was made in distributing the varieties before they had flowered in this country. The error has not been repeated, for all chrysanthemums imported from any country are now flowered, and carefully compared with existing varieties before they are offered to the public, and great care is exercised in keeping them true to name. Had Mr. Waterer held back his collection until each variety had flowered, his profits would have been far greater, for the majority of the varieties were so much superior to anything in that line heretofore imported from Japan, that after they had been exhibited, the sales for them would have been limited only to the number of plants propagated. They were all distinctively Japanese varieties, though representing different types. Mrs. Charles H. Wheeler was a great improvement over anything that had been known in chrysanthemums. Its constitution is not of the strongest, but when seen in good condition it always leaves a favorable impression. Mrs. Frank Thomson, though not of the type which meets with the most favor in England, is nevertheless one of the best for this climate, being a healthy grower and freely producing its very large flowers. It is con-

sidered too coarse in Europe, especially in England, where the compact Chinese section seems to be looked upon with the most favor. The Chinese varieties do not flourish satisfactorily in many localities in this country, especially when grown out-of-doors all summer. Mildew plays sad havoc with them, frequently destroying the foliage. Mrs. George Bullock, of the Waterer collection, would, I think, suit the people of England. It is a robust grower, yet quite dwarf in habit, and its dark, healthy foliage forms an ample setting for its large, pure, white flowers, which are full to the center. The floret-petals are narrow and somewhat erect, though not by any means stiff. It is a great favorite here, both for exhibition and cut-flower purposes. It is believed to be identical with *Domination* and *Milkmaid*, and it is to be regretted that some reputable men in the business retain all three of the names on their lists without a word of caution or explanation. A good word could be said for nearly every variety of the collection.

Shortly after these new and unique varieties were introduced to commerce, Mr. W. K. Harris began to experiment with seed saving and seedling raising, and it is now generally conceded that he has raised more sterling varieties than all other growers in this country combined.

A demand for very large flowers on long stiff stems for cut-flowers has sprung up in most of the large cities, and the selection of seedlings is influenced to a large extent to supply that demand.

The prices realized this year have been fairly remunerative to the grower, especially in the New York market, where the wholesale price frequently goes as high as \$50 per 100 blooms. In Philadelphia the highest price paid was \$25 per 100, and these were for the choicest of the choice.

According to the European standard, it is not correct taste to cultivate, to the exclusion of all other varieties, what are termed the coarse sorts. There are large numbers of the Japanese varieties to which the name "coarse" cannot be applied, however. An instance is *James Y. Murkland*, which may be termed single. It shows the center very conspicuously. It has three or four rows of exquisite white floret-petals, which have a tendency to curl. This was raised by Mr. John Thorpe, the pioneer chrysanthemum man in this country.

This variety was, for about three years, a favorite in Philadelphia, as also was Sadie Martinot, which is almost identical with Murkland, except in color. Now they are displaced by varieties like Mrs. Wm. K. Harris (yellow) and Mrs. M. J. Thomas (white). It appears that the larger varieties appeal to the public eye more quickly than the small ones, but tastes will change soon, for more refined flowers must become favorites.

A list of the new varieties which are to be introduced through the channels of trade is given here. Most of them are seedlings raised within the city limits of Philadelphia; those imported have not been nearly so satisfactory for the past year or so.

Those to be sent out by H. Waterer are as follows :

Reward. (Harris.) Reddish maroon, very distinct in color; immense spreading flower.

President Harrison. (Monahan.) Red, with a salmon tint, deep red in the center of the flower, which is cup-shaped; enormous flower; good grower.

Mrs. Frank Clinton. Light canary yellow in color, flower full to the center; plant of good habit; quite distinct.

Gipsy. Bright mahogany red; very effective; incurved flower; good grower.

Model. Light pink, somewhat deeper in color than Lillian B. Bird; a pleasing shade; quite double, resembling the variety Gold in shape.

Miss Minnie Wanamaker. Full flower, yellow center; outer floret-petals white and drooping.

White Cap. Upper part of flower white, deep violet purple beneath, incurving when first open, afterwards drooping; quite distinct.

Twilight. Large flat full flower, in shape similar to Excellent; lemon-yellow center; outer floret-petals white; very fine.

Edwin Lonsdale. This is said to be the deepest and richest colored variety ever seen. It does not fade like so many high colored varieties; large full flower; dwarf in habit.

Mrs. Charles Dissel. Immense flower, incurved; light though bright pink in color; a great improvement on Mrs. Frank Thomson; one of the largest chrysanthemums in cultivation.

Hill & Co. will send out the following :—

Henry Elkins Widener. (Jamison.) This was awarded the “Blanc Prize,” in Philadelphia, twenty-five dollars, as the best seedling in bloom, never before exhibited and not in commerce. It is lighter in color than *Grandiflorum*, also larger, and the flowers are carried erect on strong stiff stems, which will insure its becoming a favorite both for exhibition purposes and for cut flowers. It has a little history which will be interesting. It was raised by Mr. William Jamison, gardener for R. C. Mason, Esq., who sold it to Hugh Graham’s Son. He sold it to Robert Craig for \$300, who in turn disposed of it on advantageous terms to the present owners.

Crown Prince. (T. Monahan, gardener for C. W. Trotter, Chestnut Hill.) A magnificent incurved flower, in the way of Mrs. Charles H. Wheeler, but it is more than twice as large. In color it is crimson on the upper surface of the floret-petals and bronzy yellow on the reverse.

Mrs. J. T. Emlen. (Monahan.) This is a decided improvement on Mrs. Carnegie, both in color and constitution. It is a good grower and throws its flowers well above the foliage on stout stems.

Molly Bawn. (Monahan.) This is a pure white sport from *Syringa* ; very large ; fine for exhibition purposes.

Mrs. Winthrop Sargeant. (Harris.) Very pale yellow, a new shade of color difficult to describe ; the flowers are very large and incurved, and are freely produced on erect stems ; a grand flower.

Mrs. Edmund Smith. (Harris.) Beautiful pure white with long and narrow floret-petals which are of great substance ; beautifully interlaced ; it remains a long time in perfection ; exquisite.

Carrie Denny. (Harris.) Another new shade, in color a deep rich yellow, suggesting amber ; incurved.

Miss Mary Weightman. (John McCleary.) In the way of Mrs. Wm. Mencke, but larger and at least two weeks earlier than that old favorite.

Robert S. Brown. (Monahan.) Similar in color to Hon. John Welsh. It is a healthy grower and a free bloomer and the flowers are four times as large.

John Lane. (Harris.) Lovely pink in color, incurved in shape. It is considered the best pink in existence for cut flowers.

Charles A. Reeser. (Harris.) Violet pink, a new shade not easy to describe; reflexed flower; good habit. This will make a good variety for specimen plants for exhibition.

Clara Riemen. (Riemen.) Lavender, shading to silvery rose, white centre; large spreading flower, of good substance.

T. H. Spaulding will send out: Ada Spaulding, Addie Decker, Antoinette Martin, Cyclone, E. Gurney Hill, G. P. Rawson, Garnet, J. R. Pitcher, Mrs. D. D. L. Farson, Marie Ward, Mrs. T. A. Edison, Mrs. Benjamin Harrison, Zenobia.

§ 3. CHRYSANTHEMUM SHOWS OF 1889. BY JOHN THORPE, IN THE AMERICAN GARDEN.

Never before have there been such shows as those of the present year. It is really surprising how the cultivation of the chrysanthemum is taken up, and with what enthusiasm it is diffused. It has been said for three or four years that after another year this chrysanthemum craze will be at an end, as there will be nothing new to offer, and the people will tire without novelty. Those who made such predictions can do so again, and at the end of a decade they will be farther from the end than now, so far as public interest is concerned. The magnificence and extent of the exhibitions of this year on the whole surpass any we have had in the country before. The decorations and arrangements of each exhibition have been a special feature, all different, all in good taste and thoroughly well done. There have been the finest 12 plants and the finest 300 cut-flowers ever seen in the country. There are seedlings surpassing all we have in cultivation; one, a novelty from Japan, that may be sought for more than the famous Mrs. Alpheus Hardy.

The show of the National Chrysanthemum Society was held at Indianapolis, November 5th to 10th.—The show was a success in every way. The decorations were exquisitely done and delightfully effective. Wreaths of laurel in festoons hung from point to point, from which again hung Florida moss (*Tillandsia usneoides*) yet not in sufficient quantities to interfere with the general arrangements. The balcony was draped

with white cloth on which were Japanese emblems in bright colors. From the center of the hall was suspended a pyramid of brilliant colors of Japanese construction. The hall was brilliantly lighted by electric light. The plants were arranged in informal groups on the floor, and were very effective. They came from Henry Rieman, Fred Dorner, Berterman Bros., Hill & Co. and John Hack. The competition was severe in many of the classes, Mr. Rieman winning the first in the class for 25 plants. The greatest interest centered in the competition for the national prize, a silver cup given by Mrs. President Harrison for the best new seedling, for which there were upwards of a dozen entries. After an hour's hard work, the cup was awarded to T. H. Spaulding for *Ada Spaulding*, a globe-flowered Japanese of immense size, the lower half of the flower being rosy pink and the upper half pure white. Mr. Rieman's *Emily Rieman*, a large, full, pink-shaded Japanese; Mr. Dorner's *Emily Dorner*, a broad petalled whorled bronze, and *Mistletoe*, a bright silver and lake incurved globular flower, were also very fine, and were awarded first-class certificates of merit. Mr. Spaulding obtained first-class certificates for *E. G. Hill*, *Mrs. B. Harrison* and *Cyclone*. Hill & Co. were awarded a first-class certificate for a French variety, *Souvenir de l' Exposition de Marseilles*. First prize for 25 varieties, 12 of each, cut-flowers on long stems, was awarded to John Rose, gardener to F. T. McFadden. This exhibit was the best I have ever seen; there was not a weak flower in the whole of this showing. Here is his list complete: *Mrs. A. Hardy*, *Golden Dragon*, *Grandiflorum*, *Mrs. Irving Clark*, *Mrs. E. W. Clarke*, *John Welsh*, *Mrs. Langtry*, *Alcyon*, *Mrs. Townsend*, *L. Canning*, *W W Coles*, *G. F. Moseman*, *Duchess*, *Fair Maid of Guernsey*, *Source d'Or*, *John Thorpe*, *Yeddo*, *La Tonkin*, *Christmas Eve*, *Wm. M. Singerly*, *Louis Bonamay*, *Mons. A. Deleaux*, *Martha Harding*, *Marvel*, *Cullingfordii*. The competition in the other classes for cut-flowers was brisk and the displays good. The competition for designs of various kinds was very close, and as a rule good taste and good workmanship were displayed throughout.

The display of roses proved that as good flowers can be grown in the west as in the east. Mr. Hunt's collection has not been surpassed at any November exhibition in

the country, his Mermets, Hostes and Albany being superb. Mr. Hill showed several new kinds, which had many admirers, notably Duchess of Leeds and Gustave Nabonnand. Mrs. H. Hilker won the prize offered by Mr. Hunt for a collection of roses, among which were superb flowers of Sombrieul and Marechal Niel. Mr. A. Wiegand won the oriental prize with an ottoman of chrysanthemums. The secretary, Mr. W. H. Berterman, and the whole of the Indiana Florists' Club were indefatigable in their work and efforts to please.

Chicago. My conferree writes that the show was a glorious success, and that they have made "seven-league strides" since last year, the interest shown being almost at fever heat. The plants were better, the cut-flowers were better and the whole show far superior to any ever held there.

Cincinnati. The plants shown by Frank Hunt's gardener were equal to many of the best shown in the country. Other plants were of great merit, while the cut-flowers of Mr. Peterson and Mr. Sunderbruch were almost equal to those shown by Mr. McFadden at Indianapolis. The competition in designs of various flowers was up to the Cincinnati standard. The decorations of the hall were elaborate and in good taste, reflecting great credit upon President Mitchell and the Cincinnati Florists' Club.

Detroit. The exhibition far surpassed the most sanguine expectations, the plants and cut-flowers being exceedingly fine. A telegram received on the second day of the show says: "It looks now as if we shall have every man, woman and child in Detroit to see our magnificent exhibition."

Philadelphia. The Pennsylvania Horticultural Society has this year surpassed any of its previous efforts. Three years ago, when Robert Craig showed his 25 plants, admitted then to be invincible, it was said that that was the limit to specimens in pots, and from that time we should recede. What poor prophets, the winners of the first prize this year were 25 per cent. better. The winners of the second prize were 20 per cent., the winner of the third prize 12 per cent., and the three other collections were equal to the champions of '86.

The first prize of \$100 for 12 plants was awarded to James Verner, gardener to A. J. Drexel; second to Gordon Smirl,

gardener to Wm. M. Singerly; third to Wm. K. Harris; fourth to George L. Fowler, gardener to Joel J. Bailey; fifth to John McCleary, and sixth to J. W. Colflesh. The plants winning the first prize were marvels of skillful cultivation, counterparts of each other in size, and nearly equal in numbers of flowers. They were nearly five feet in diameter; the tallest plant from floor line to topmost flower was 3 feet 10 inches, the average number of flowers being 94, all perfect in color and shape. The foliage was fresh and bright, and but few supports could be seen. They were well staged and plainly labelled. The second lot was only a few points behind, the plants being even larger but not quite as even or as well staged; the third lot was similar, being perhaps a little more uneven in size. The competition in all the other chrysanthemum plant collections was nip and tuck, and never before have there been so many good plants gathered together. In the cut-flower division, excellent flowers were shown by Jno. Cullen and W. K. Harris. The interest in the 47 seedlings shown for the various prizes proved to be most intense, and it was not without serious deliberation that the premiums were awarded. The Blanc prize, a silver cup, was awarded to Hugh Graham & Sons for a superb yellow variety, lighter in color than Mrs. W. K. Harris, and of fine habit, named Henry Elkins Widener. A silver medal went to T. H. Spaulding for Ada Spaulding. A silver medal to Peter Henderson for Louis Bøehmer, a lovely variety, silvery pink in color and a counterpart of Mrs. Alpheus Hardy. To John Thorpe, for Coronet, rich yellow and bronze, was awarded a silver medal. To W. K. Harris, silver medal for Violet Rose, a grand double carmine rose kind. To John M. Hughes, gardener to G. W. Childs, for Mrs. Ley, an incurved pink and white flower. To Thomas Monahan, silver medal for El Dorado, a superb rich yellow. Certificates of merit were awarded to several other valuable seedlings. Pitcher & Manda, of the United States Nurseries, showed many promising seedlings and some new varieties of merit.

Superb collections of roses were exhibited by Messrs. Craig, Coles & Whiteley, Evans & Battles, Pennock Bros., and Kift & Sons. Among the displays of decorative foliage palms and ferns, there were some of the most perfect specimens ever looked upon. For 25 ornamental foliage plants, Wm. Joyce was

first, Robert Work second. For 25 palms, Thomas Long took first prize. Other exhibitors were Wm. Lafferty, Robert Work, Hugh Graham & Sons, H. A. Dreer, H. Heacock, J. H. Campbell & Son, C. D. Ball. Of palms alone, there was sufficient to make a large exhibition. The designs were not up to the standard. Interesting displays of fruits and vegetables were shown. The decoration of the hall was in good taste. Fine effects were produced by the use of evergreen branches and fine colored oak foliage. The secretary, D. D. L. Farson, and his able assistants, rendered valuable aid to all concerned.

Boston. The plants were equal to any ever shown at the "Hub," the cut-flowers being a decided improvement on last year. Magnificent flowers of *Jardin des Plantes* and *Cullingfordii* were the greatest attractions among older kinds. Best 12 flowers were shown by Mr. Brydon, of Yarmouthport, Me. Some promising seedlings were exhibited by several exhibitors, and the show promises to be more successful than any of its predecessors.

Orange, N. J. The exhibits were confined to a few persons. The most interesting groups were the grand standards, shown by John Farrell, gardener to Wm. Barr, and George Atkinson, gardener to Thos. H. Spaulding. These plants were covered with flowers most perfect in form and of largest size. Good bush plants were also shown by the above and Mr. Page. Cut-flowers of the finest quality were shown by Wm. Tricker, gardener to Judge Benedict; Thos. H. Spaulding, John Cullen, the United States Nurseries and John H. Taylor. The display of roses by Messrs. May and Taylor was excellent, and called forth many encomiums. A group of chrysanthemums in six-inch pots, shown by Messrs. Spaulding and Barr, and a select collection of stove and greenhouse plants from the United States Nursery, were very attractive. Carnations were shown by Mr. Taylor and Wm. McGowan, the latter showing Lizzie McGowan, a very promising new white seedling.

§ 4. SOME OF THE NEW CHRYSANTHEMUMS. BY JOHN THORPE,
IN THE AMERICAN GARDEN.

Out of nearly 1,000 varieties to be found in cultivation, it would be strange if there were not some kinds that it would be difficult to improve in any way. There are many of the older sorts which it would seem impossible to displace, as they hold their positions each year in spite of the hundreds of newcomers. Yet there are more and better new kinds this year than ever before. It is of these and the new ones of last year that we wish to present a list. That American-grown seedlings are far surpassing the European kinds cannot be gainsaid. That is to say, the American-raised seedlings give more satisfaction, as a rule, in America than do the varieties produced in Europe.

Of last year's American seedlings, the following are really first-class: Beauty of Castlewood, red and gold; E. H. Fittler, gold and bronze; Coronet, golden orange; Mrs. W. K. Harris, pure gold; Colossal, white and pink; Excellent, rose-pink and lilac; Adriance, lovely shade of rosy lilac; Miss Anna Hartshorn, pure white; Violet Rose, carmine, shaded rosy purple, superb; Llewellyn, red and gold; Mrs. Wm. Barr, plum purple, new color, fine; Mrs. Judge Benedict, white anemone; Mrs. M. J. Thomas, white; Mrs. Irving Clarke, pink; Thos. C. Price, Mermet pink; Mary Wheeler, silvery blush; Sunnyside, white; Mrs. A. Carnegie, crimson; Zillah, bronze and cherry red; Mrs. A. C. Burpee, chrome bronze.

Of Japanese importations, first is Mrs. Alpheus Hardy, with its chaste and distinct character; Kiota, golden yellow; Lilian B. Bird, silvery blush; Mrs. Fottler, rosy pink; Neesima, gold; W. H. Lincoln, glorious yellow. Other Japanese importations by way of Europe are: H. Cannell, yellow; Ed. Molyneux, crimson and gold. Lady Lawrence, Mrs. Dunnett and Mrs. H. Cannell are identical with Robert Bottomley, Mrs. J. N. Gerard and Christmas Eve, which we have had for the last four years.

Of the English raised kinds, Sunflower, rich yellow; Avalanche, white; Mrs. F. Jameson, bronze salmon; Mrs. John Wright, white; Stanstead, white; Carew Underwood, red and bronze, are all good. Among the continental seedlings, out of 140 kinds the past two years, the following are worthy: Mme.

Mezard, purple, spotted white; Mme. Camille Richard, salmon rose; M. Ed. André, bronze; M. C. A. Carrière, white, perfect shape, very large; Shasta, pure white, with narrow incurving petals; Ramona, golden yellow, same type as above; Bohemia, mahogany red, reflexed, solid flower; John Lane, silvery pink, large and good; Crown Prince, bronze and gold; Mrs. J. K. Emlen, crimson and bronze; Pæony, purple red with strap-like petals; Mistletoe, silvery blush and purple crimson, incurved and very distinct; Emily Dorner, bronze with whorled petals, large; Emily Rieman, soft pink, shaded white, fair size; Mrs. W. H. Trotter, a peculiar flower, part incurved and part reflexed, pink and silver; El Dorado, intense gold color, incurved; Adirondack, white, reflexed, fine; Lady Selkirk, pearly white, incurved; Mrs. DeWitt Smith, blush pink and silver, large and fine; Zenobia, very large, reflexed and whorled, white; Elliott F Shepard, paper yellow; London Humphrey, pink, large, distinct; Mrs. Ley, white, like Domination, with pink shadings; Lemonade, bright lemon, early; Cypiere, rose and white; Mme. Ed. Rey, currant-red; Perle Poitevine, white; Exposition de Triomphe de Marsielles, buff; Comte de Monstic, red; M. H. Payne, flame red; M. Bernard, amaranth; M. Paukouski, anemone, bronze; Sabine, anemone, lemon and white; Nelson, amaranth, anemone; Veil d' Or, gold; M. Garnar, gold; Mad. Baco, rose-pink; Claude Sahut, blush, tubular; Alcyon, solid rose-pink; Mme. L. Leroy, pure white.

Here are 20 American seedlings, 8 Japanese importations, 6 English varieties and 19 French kinds—a total of 43, and all meritorious.

Of the new seedlings which have been shown at our exhibitions or have come under my notice, the following promise to be most valuable acquisitions: Ada Spaulding, a large and fine globe-shaped Japanese of sturdy habit, silvery white and blush-rose, beautiful; Grove P Rawson, buff and apricot, new color, very fine; Henry Elkins Widener, clear golden yellow, excellent; Mrs. Thos. A. Edison, incurved, pink, silvery, reflexed, distinct; Cyclone, an immense white flower of a new shape; E. G. Hill, rich chrome and bronze, flowers of fine shape, reflexed and full; Rosebank Gem, large flower, pink and white, distinct shape; Peculiarity, a variety with tube petals, distinct pouch-like, notched and toothed at the

extremities ; Oriole, golden yellow with twisted petals. Here are 9 new candidates, and as I have said, they all promise to be of the highest merit. It must be borne in mind that I have not seen all seedlings this year, and there may be some even better than any here named. I have passed over at least 300 varieties in making the above selection. Before closing I mention the new imported Louise Bøhmer, a pink Mrs. Hardy ; it will be a valuable acquisition. In the same collection is Omar, a reflexed flower having petals of a deep blood color and $\frac{3}{4}$ of an inch wide. The sports from the Chinese varieties, Mrs. S. Coleman, Violet Tomlin and Mrs. M. A. Haggis will find many admirers.

§ 5. CHRYSANTHEMUMS OF 1889. BY H. P. WALCOTT, IN "GARDEN AND FOREST."

The record of the year, so far as the introduction of new varieties of great promise goes, has not been an encouraging one. A larger number of new kinds than has ever before been offered appeared in the spring catalogues of growers in America and Europe ; and, with very few exceptions, the experience of this season will probably strike from the list nine-tenths of them as not having sufficiently distinct qualities to justify their propagation. Some allowance should be made for the unfavorable influences of an exceptionally bad season for plants grown in the open ground. But the new flowers are not, in themselves, either in form, color or substance, marked improvements on those already in existence.

Mrs. A. Hardy, the principal novelty of the year, notwithstanding its apparently great vigor of growth, has not done well ; not a plant of it was shown at the Chrysanthemum Exhibition of the Massachusetts Horticultural Society. The flowers, however, were shown, and have the same attractive qualities that excited so much enthusiasm last year. There has also been exhibited this season, under the name of Louis Bøhmer, a flower having the hairy petals peculiar to Mrs. Hardy. The color of the flowers, however, is a dull pink, not at all pleasing, at least in the specimen shown at Boston. Whether Louis Bøhmer is a sport from Mrs. Hardy or an original seedling imported from Japan was not stated.

Messrs. Pitcher & Manda have received, in a recent impor-

tation from Japan, among some very promising chrysanthemums, another specimen of Mrs. Hardy. Among the seedlings of this variety raised by Mr. Manda, and shown by him during the season, there has been no appearance of hairs. One of the seedlings, named Bohemia, is a large, dark flower of decided promise. Strangely enough, there does not appear to have been any sport from Mrs. Hardy, though the unusually large numbers of that variety which have been grown this season would lead one to expect this not unusual occurrence.

Of the varieties of recent introduction, the following may be noted: Alcyon, Délie, Superbe Flore, Madame Pepee, Val d'Andorre, Ed. Audiguier, W. H. Lincoln, L. B. Bird and John Thorpe, all Japanese, have done well; Mrs. G. Wright, Avalanche and Condor are three good whites of the reflexed Japanese type; Mrs. H. Cannell, white, incurved Japanese, has not done well, while Mr. H. Cannell, though not a very free flowerer, appears to be a real addition to the large yellows of the old Grandiflorum class; Mrs. N. Davis, a yellow sport from Princess of Teck, has all the good qualities of one of the best of the large incurved Chinese kinds; Marie Ouvray has not shown itself to be a valuable addition to the long list of early flowering varieties of more or less distinct violet shade; M. Garnier, a Japanese, with yellow ground, shaded and striped brown-red, is a fine variety; Souvenir d'Alfred Motte, reflexed Japanese of a peculiar color, magenta and buff, is worth adding to a large collection, and so, too, is Mrs. Falconer Jameson, one of Cannell's new varieties, a flower colored buff and red, with yellow points; La Tosca, Japanese, fiery crimson, striped brown, though a small flower, is good and distinct; Cythere, of the same class, purple-amaranth and shaded dull red, is also good; Magicienne, a Japanese, chamois with light rose tints, is a large and early flower; Vieil Or, though very rich in color, is too flimsy in substance to be useful; Etoile de Lyon, a deep lilac-rose, margined with silver, of large size, though it has not done well here, has succeeded so well on the other side of the ocean that it should be given a second trial.

The incurved Chinese flowers have fallen into undeserved neglect in later years, and the few valuable additions to this class have not attracted the attention due them. One of the best of these newcomers is M. Roux, a seedling raised by Boucharlat and introduced in 1884. It has retained, even

this year, its good qualities of a low habit of growth and well shaped, closely incurved flowers, of a bright chamois yellow. Ralph Brocklebank, a yellow sport of the old variety Meg Merrilles, has the same serious defect, a dark center.

The seedlings of the year of American production are not very numerous, nor are they, as a whole, very promising. They have generally been exhibited as single large flowers grown to the fullest size that high cultivation can give them. It is not easy, therefore, to say how valuable they will prove for general cultivation. It is, unfortunately, true that many of the best new seedlings have been plants of bad constitution, capable of yielding, in the hands of expert gardeners, wonderful results, but comparatively valueless for the average grower. Some most remarkable flowers, exhibited at the Boston show by Mr. Brydon, gardener to Mr. Simpkins, were largely of this class. Better flowers were never exhibited here, and, probably, better could not be seen on any exhibition table in the world; but if the ordinary grower should select these plants for his own collection he would inevitably be disappointed in the results of his cultivation. Mrs. Andrew Carnegie, one of last year's seedlings, was shown by Mr. Brydon in good form and bright color, but the same flower, as exhibited by other growers, was dull and unworthy of its reputation. Ada Spaulding is not attractive in color, at least was not so at the Boston exhibition, and is no better in size and form than many more highly colored flowers already in the market. The other conspicuous seedlings of 1889, so far as they have been seen, must, in my opinion, await the results of another season's cultivation before they can be awarded a very high place on the list.

3. *Roses.*

SOME OF THE NEWER VARIETIES OF ROSES. BY E. G. HILL, IN
GARDEN AND FOREST.

The list of new roses for 1888 and spring of 1889 was an unusually large one, about equally divided between the Hybrid Perpetuals and those known as Ever-bloomers in this country, including Teas, Polyanthas, Hybrid Teas, Noisettes, Bourbons and Chinas. It is impossible to determine the value or quality of a Hybrid Perpetual with a single summer's trial,

but my notes made in England and on the Continent during August last may indicate varieties that will probably prove useful in this country. Oscar II, King of Sweden, was introduced by Soupert & Notting, of Luxembourg. Color is the remarkable feature about this rose, it being a maroon-brown; or, to put it another way, a brown-crimson. A strong, vigorous grower, with large leathery foliage, it produces flowers quite double and of fair form. It has a rival in Sir Rowland Hill, an English introduction of the previous year. This is a fine, erect grower, and, if vigorous enough when grown on its roots, will be much sought after when known in America. It, too, is a maroon-crimson, with just enough lustre to light the flower up nicely. It is similar to Duke of Edinburgh in habit and form. Both the above roses are decided departures in color, and from what I saw of them, they appeared very free in the production of flowers. Caroline d'Arden, raised by Dixon, of Langport, Ireland, is a rose of much promise from its sturdy habit and fine, open-faced flowers, which are produced in abundance considering the size of the flowers. It is of a bright cherry-rose, one of those appealing tints that one cannot help liking. Countess d'Eu (Verdier) is a fine globular flower of a bright cerise-rose color, flushed with vermilion. It is a rose of excellent shape and a fascinating color. Marquis of Salisbury, raised by Levéque, is of a bright rose-crimson, shaded with silver. Its attractive color, with its fine shape and great masses of flowers, impressed me greatly.

Duchess of Albany and Duchess of Leeds, both English-raised roses, are classed as Hybrid Perpetuals in Europe, but they are both bred like the well known La France. The first is a rose of decided value. As seen growing with the originators, Messrs. William Paul & Son, it was all that could be desired, being larger in size, deeper in color and stronger in growth than its parent, La France. Duchess of Leeds, at certain stages of its development, is finely colored, and has a bright, crisp appearance. Its weak point is its slaty or dead pink color when fully expanded. The outer or reverse side of the petals is always of good color. To my notion it is a good, useful rose, but would not please the fastidious on account of its short petals and ashen color when fully open. The two sports from Lady Mary Fitzwilliam, White Lady (Paul) and

Maid of the Mist (H. Bennett), are very fine as seen growing and flowering in the genial climate of England, but are of no use here on account of their inability to withstand the fungous disease commonly termed black spot. One of the finest roses in England is the parent of these two white sports, but it is valueless here on account of the disease mentioned. Cheshunt Scarlet (George Paul) is a brilliant crimson-scarlet, and the nearest approach to a pure scarlet of any rose we know. It is from that splendid race of roses beginning with Duke of Edinburgh and running through most of the seedlings raised at the Cheshunt nurseries. It is semi-double, with broad petals, and will make up in color for deficiencies in other directions. Marchioness of Lorne, as grown at Waltham, is very nearly an ideal rose, splendid in form, bright crimson-rose in color, sweet-scented, producing its buds and bloom with a lavishness unknown to most roses of its class. Unfortunately, it does not maintain its perpetual flowering character when transplanted to American soil, as plants introduced last spring behave like all other remontants. The roses mentioned above are likely to prove valuable, and are distinct enough from existing kinds to warrant a trial on this side the water.

Count Henri Rignon is a fine, distinct Hybrid Tea, raised by Pernet, of Lyons—a grand rose, as seen in the gardens in the south of France, and it gives much promise on this side of the Atlantic. It is equal to American Beauty in size, but of a light, silvery flesh tint, which is decidedly pleasing. Our growers might try forcing this variety in the way that American Beauty is grown. It would sell if well done. Ernest Metz, a large silvery pink flower, tinged with flesh color, of extra large size, and Madame Pierre Guillot, a rose of the Watteville type, are the two most promising teas of the year; and for bedding purposes in the open ground they will please the fancy of critical rosarians. They are the product of that cautious and conscientious man, M. Pierre Guillot, of Lyons, who has done more, perhaps, than any other one man to enrich our gardens with good varieties.

We are testing other varieties of Tea Roses, but the propagator's knife has despoiled them to such an extent that they must wait until we can judge them properly. I might mention The Queen, raised in this country, a sport from that old

favorite, *Souvenir d'Un Ami*, and a fine rose for bedding in the open ground. *Clotilde Soupert*, said to be a hybrid *Polyantha*, is, perhaps, the rose of most value on this side, out of the many introductions of 1889. It is nearly the size of the fine *Hybrid Noisette*, *Boule de Neige*, but differs from that variety in being short-jointed and truly perpetual, as much so as any of the common *Chinas*. It also promises to be hardy in our northern climate, and if so it will be of great value. Whether it is a *Polyantha* or a *Hybrid Noisette* matters little if it continues to do as it has done the past summer. It was raised by *Soupert & Notting*, *Luxembourg*, who declare it to be a true descendant of the *Japanese Fairy* or *Polyantha* *Roses*.



CHAPTER IV

PLANT DISEASES AND INSECTS.

I Vegetable Pathology.

The subject of vegetable pathology is yet so new that the term itself is unfamiliar. It has long been known that plants have diseases, but in a popular and practical way the knowledge has been productive of few results until the present time. In general, the most destructive diseases are those caused by the attacks of parasitic plants, yet there are diseases of nutrition. The term vegetable pathology has come by custom to apply only to diseases which are fungous or fungoid in their nature, a limitation which in many respects is unfortunate.

Great activity has been shown in the study of injurious fungi in very recent years, and results of inestimable economic value have been obtained. The investigation has been undertaken by specialists connected with the agricultural colleges, and later by those working with the experiment stations, but the work fostered by the Department of Agriculture has been the most systematic and various. The section of vegetable pathology has a considerable force of skilled men in the laboratory and field. During 1889 agents of the section were located in New Jersey, Delaware, Virginia, South Carolina, Mississippi, Missouri, Michigan, Wisconsin and California.

A great range of subjects has been investigated, and the literature of plant diseases is increasing with great rapidity. The most signal advantages of these investigations have been those in connection with the diseases of grapes. The black-rot and mildews have been so disastrous to grape culture in many parts of the country that growers

have often despaired of further profit. Yet the experiments undertaken by the Department of Agriculture in 1888 show that both these diseases can be almost wholly controlled. "The results have been such as to justify the conclusion that we now have both downy mildew and black-rot, the two worst enemies to American viticulture, entirely under our control." Experiments of the present year justify this statement. The cost of the application of remedies, while considerable, is not burdensome, and the results appear to be certain and positive. Investigations made by the Delaware Experimental Station in 1889 upon "a vineyard of twelve hundred vines, which occupy an area of 61,000 square feet, or approximately one and four-tenth acres," gave the following figures: "The net cash income from sprayed vines during the past season was \$144.40. The treatment necessary to protect these vines from the disease known as black-rot involved an outlay of \$36.10, leaving a cash balance of \$108.30. Proof is furnished that without this treatment the total net income from the vineyard would have been \$20.63." Others have secured cheaper results with apparently no loss of efficiency.

The results attained with grape diseases are prophetic of what may be expected in other directions. Already the potato-rot has been treated with every indication of success. The leaf-blight of the pear and powdery mildew of the apple, diseases which are often ruinous to nursery stock, and the first of which renders the growing of pear stocks a failure in most parts of the country, have recently been treated with eminent success upon a very large scale. A block of 50,000 pear seedlings and several blocks of apple seedlings, aggregating about 390,000 stocks, growing in the vicinity of Washington, were almost entirely rid of disease at a very low cost.

The treatment for many of these parasitic diseases consists in spraying the plants at proper seasons with some preparation of sulphur and copper. The greatest success has been obtained with the Bordeaux mixture, a simple combination of sulphate of copper and lime. The cost of making and applying this material to 30,000 apple seedlings, averaging a foot and a half in height, was found by Mr. Galloway, of the Department of Agriculture, under whose direction the above experiments were conducted, to be 79½ cents. A block of

young trees containing 200,000, two-thirds of which were budded stocks, was sprayed twice at a total cost of \$8, and two other blocks, containing 150,000 and 40,000 seedlings respectively, were sprayed six times at a cost of \$22.80.

Many growers assert that the cost of applying fungicides and insecticides, even though it is slight, cannot be afforded at the present returns for products. But growers always find that it pays to save their crops. In fact, thoughtful cultivators are aware that increased profits usually accrue to those who succeed in the face of obstacles that are widespread. This is due to the fact that the masses fail, and competition is lessened. It is unquestionably true that there would be no profits in fruits and vegetables, or in any produce, in fact, if every one could grow them with ease. In this constant warfare in the interest of his crops, the intelligent and vigilant cultivator has great advantage. And much satisfaction in tilling the soil comes when the farmer learns this simple philosophy, that all obstacles are prime factors in his education and are usually directly profitable to him who overcomes. Weeds have taught the use of the plow and hoe. Even Virgil knew and taught this philosophy:

“ The father of humankind himself ordains
The husbandman should tread no path of flowers,
But waken the earth with sleepless pains.
So pricketh he these indolent hearts of ours,
Lest his realms be in hopeless torpor held.

* * All these things he did
That man himself, by pondering, might divine
All mysteries, and in due time conceive
The varying arts whereby we have leave to live.”

2. *Economic Entomology.*

Great strides are making in economic entomology. The natural histories of insects in their relations to requirements of cultivators, and the application of insecticides upon a large and profitable scale, are coming to be well understood. In fact, we have now reached an epoch when despair does not seize the cultivator if some new and dreaded depredator attacks our crops. Increased vigilance and determination, rather than abandonment, result from such attacks. The employment of arsenical sprays is no doubt destined to revolu-

tionize our dealings with many or most injurious insects. Their use, both in extent of territory covered and in the kinds of insects attacked, is increasing with great rapidity.

But the boldest stroke in checking insect ravages is the wholesale introduction from a foreign country of parasitic insects to prey upon the injurious ones. Perhaps the most destructive insects to fruit trees in this country are the white and red orange scales. These insects have ruined many orange groves in California, and have caused widespread alarm on the Pacific coast. The white scale, *Icerya Purchasi*, is particularly destructive, and is exceedingly difficult to combat. Professor Riley, of the National Department of Agriculture, determined that the insect is a native of Australia, where it is kept in check by certain parasites. A movement was at once set on foot to import these parasites, and two of the agents of the department were dispatched to Australia for this purpose. A lady-bird beetle, known as *Vedolia cardinalis*, has so far given best results in destroying the scale. Mr. Coquillet, of Los Angeles, who has had charge of the breeding of these insects, describes the progress of the work as follows: * “The first consignment of these lady-birds reached me on the 30th of November [1888], and numbered twenty-eight specimens; the second consignment of forty-four specimens arrived December 29th, and the third consignment of fifty-seven specimens reached me January 24th, making one hundred and twenty-nine specimens in all. These, as received, were placed under a tent on an icerya-infested orange tree, kindly placed at my disposal by Mr. J. W. Wolfskill, of this city. Here they were allowed to breed unmolested, and early in April it was found that nearly all the iceryas on the inclosed tree had been destroyed by these voracious lady-birds. Accordingly, on the 12th of April, one side of the tent was removed, and the lady-birds were permitted to spread to the adjoining trees. At this date I began sending out colonies to various parts of the state. * * * * * By the 12th of June we had thus sent out 10,555 of these lady-birds, distributing them to two hundred and eight different orchardists, and in nearly every instance the colonizing of these lady-birds on icerya-infested trees in the open air proved successful. The orange and

*Insect Life, ii. 73.

other trees—about seventy-five in number—and also the shrubs and plants growing in Mr. Wolfskill's yard, have been practically cleared of iceryas by these lady-birds, and the latter have of their own accord spread to the adjoining trees to a distance of fully three-fourths of a mile from the original tree.

“Besides the three consignments of these lady-birds referred to above, I also received two later consignments. The first of these reached me February 21st, and numbered thirty-five specimens; these I colonized on an icerya-infested orange tree in the large orange grove belonging to Colonel J. R. Dobbins, of San Gabriel. The last consignment of three hundred and fifty specimens arrived March 20th; one-third of these I left with Colonel Dobbins, while the remainder I colonized on orange trees in the extensive grove owned by Messrs. A. B. and A. Scott Chapman, in the San Gabriel Valley. All of these colonies have thrived exceedingly well.”

Professor Henry speaks* in unqualified praise of the success of this enterprise, and entertains great hope for the destruction of the scale. “Without doubt it is the best stroke ever made by the Agricultural Department at Washington. Doubtless other efforts have been productive of greater good, but they were of such character that the people could not clearly see and appreciate the benefits, so that the Department did not receive the credit it deserved. Here is the finest illustration possible of the value of the Department to give people aid in time of distress. And the distress was very great indeed; of all scale pests, the white scale seems the most difficult to cope with, and had no remedy been found it would probably have destroyed the citrus industry of the state, for its spreading to every grove would probably be only a matter of time.”

3. *Arsenites for the Plum Curculio.*

One of the most important results of the year is the obtaining of undoubted proof of the efficiency of arsenical spray in checking the ravages of the curculio upon stone fruits. The question has been stubbornly argued on both sides, and it is a noteworthy fact that growers, rather than entomologists or ex-

**Insect Life*, ii. 141.

perimenters, have been the first in recommending arsenites for the curculio. It is impossible to trace the practice of spraying for the curculio to its origin, or to say definitely who first advanced the idea. The practice is mostly, however, a result of the general success of arsenites in treatment of the codlin moth, although there is record of its suggestion before the spray was used upon the apple.* So long ago as 1871 G. M. Smith, of Wisconsin, recommended this remedy to the Saint Joseph, Michigan, Horticultural Society,† and there have been occasional recommendations of a similar character through the press in the meantime. The first scientist to recommend the arsenites for the curculio appears to have been Riley, who urged the matter before the Mississippi Valley Horticultural Society at New Orleans early in 1885. In 1885, Forbes, of Illinois, began experiments upon the efficiency of spraying for the codlin moth, and incidentally he made observations upon its effect upon curculios which had attacked the apples. It was found that over two-thirds of the apples liable to attack by codlin moth were saved, and over half of those liable to the attacks of the plum curculio. The first distinct record by a scientist of the application of the spray to stone fruits for the express purpose of combatting the curculio appears to be that made by Cook, in 1887:‡

“Paris green in the proportion of one tablespoonful to six gallons of water was very thoroughly sprayed upon four plum trees May 18th. The petals had all fallen, but the dried calyxes still clung to the fruit. On August 20th the trees were visited, when it was found that the two treated trees of the Wild Goose variety had dropped all their fruit, as had the untreated trees of the same kind. Another treated tree of a yellow variety was loaded with plums, of which only fifteen per cent. were stung, and those not badly. The fourth treated was a purple variety, and had not less than seventy-five per cent. of its fruit badly stung.”

This test possesses little value from the fact that untreated trees do not appear to have been compared with the sprayed trees; yet the statements came from so prominent an authority that attention was no doubt called to the matter.

Saunders§ also made statements in 1887 concerning the

* Spray of arsenical substances appears to have been first recommended for the destruction of the canker worm, and it was in combatting this insect that its effects upon the codlin moth were observed. LeBaron recommended Paris green for the canker worm as early as 1872. It was near the close of that decade that statements concerning the killing of the codlin moth by Paris green began to gain currency. Cook, of Michigan, was the first entomologist to confirm the statements.

† Riley, Rep. Com. Agr. 1888, 69.

‡ Rep. Mich. Bd. Agr. 1887, 40.

§ Rep. Fruit Growers' Ass., Ont., 1887, 58.

benefits derived from the use of Paris green upon stone fruits, but he had not made experiments.

The first publication of a well considered experiment was made by Weed in July, 1888.* Thirty-five Early Richmond cherry trees were sprayed with London purple, and other trees in the orchard received no treatment. Upon eight of the sprayed trees and seven of the unsprayed trees the cherries were picked and individually examined. Of 8,000 cherries from the sprayed trees, 280 were wormy; while of 7,500 from the unsprayed trees, 1,086 were wormy, showing a percentage of benefit in favor of spraying of 75.8 per cent. His conclusions were as follows: "1. That three-fourths of the cherries liable to injury by the plum curculio can be saved by two or three applications of London purple in a water spray made soon after the blossoms fall. 2. That if an interval of a month occurs between the last application and the ripening of the fruit no danger to health need be apprehended from its use. As a precautionary measure, however, I would advise in all cases, and especially when there are few rains during this interval, that the fruit be thoroughly washed before it is used." In October, 1888, Cook published new experiments.† A few trees were sprayed three times, June 6th, 12th and 20th. The fruit was unusually free from injury, although "cherry and apple trees near by, not sprayed, suffered seriously." "From these experiments, and those of former years, I conclude that while one application will not save our plums and cherries and prevent apples from being stung, two or three applications may be of signal advantage." In July, 1889, Forbes recorded valuable experiments in the same direction.‡ He states that "there can certainly be no further question of the liability of the curculio to poisoning by very moderate amounts of either London purple or Paris green while feeding on the leaves and fruit of peach or plum." Cook has experimented again during the past season, and he gives a review of his experience:§ "For six or seven years I have sprayed plum trees once and even twice with no apparent effect. Test trees, close beside the trees sprayed, and that were not treated, were as free from attack as were the trees that were sprayed, and the trees treated were no more exempt from

*Bull. 4, second series, Ohio Exp. Sta.

†Insect Life, ii. 3.

‡Bull. 39, Mich. Exp. Sta.

§Bull. 53, Mich. Exp. Sta.

attack than others. * * * * In 1888 I studied this matter very closely, and concluded that as the plum is a smooth fruit, with no calyx cup like that of the apple in which the poison may lodge, and as the curculio lays its egg anywhere on the smooth rind, the poison would be very easily washed off, or even blown off by the wind. I thus concluded that my want of success was very likely due to a want of thoroughness. In 1888 I sprayed certain trees three times, at intervals of eight days, and omitted to treat other trees close along side. The benefit from spraying was very marked. * * * The arsenites * * will protect against the plum curculio if they can be kept on the tree or fruit. But in the case of very frequent rains the jarring method will not only be cheaper, but much more effective.”

Weed's second experiments were published* September, 1889. Of 24,000 cherries examined from sprayed trees, 360 were wormy; while of 24,000 from unsprayed trees, 1,483 were wormy, showing a benefit from the use of London purple of 75.6 per cent. of those fruits liable to injury. The conclusions which he draws from his critical experiments are as follows :

“ This series of experiments, carried on through two seasons upon two varieties of cherry trees and four varieties of plum trees, during which a grand total of 65,500 cherries have been individually examined, seems to me to confirm the conclusions provisionally announced one year ago, which may now be put in the following form : (1) That about three-fourths of the cherries liable to injury by the plum curculio can be saved by two or three applications of London purple in a water spray, in the proportion of one ounce to ten gallons water. (2) That a sufficiently large proportion of the plum crop can be saved by the same treatment to insure a good yield when a fair amount of fruit is set. (3) That if an interval of a month or more occurs between the last application and the ripening of the fruit, no danger to health need be apprehended from its use. (4) That spraying with the arsenites is cheaper and more practical than any other known method of preventing the injuries of this insect.”

The report of the United States Entomologist for 1888, recently received, records two tests, which were made under his direction. In 1887 Alwood experimented upon Green Gage plums, spraying the trees twice with Paris green. The record shows that considerable benefit was derived from the use of the poison. Osborn, of Iowa, made experiments in 1888 upon several varieties of native plums. He finds that

*Bull. 6, vol. ii, Ohio Exp. Sta.

by "combining the entire count of all varieties, we have for sprayed trees a final of 32.48 per cent. punctured or stung, and 5.71 per cent. containing larvæ, against a final of 41.86 per cent. stung and 10.39 per cent. containing larvæ for the check trees."

The history of spraying for curculio proves that the insect can be kept in check by this means, although the advantages derived from the poison are less marked than in the case of the codlin moth. The codlin moth deposits its egg in the cup or blossom end of the fruit, while the little apple is yet erect. In this cup the poison is caught. The curculio, on the other hand, punctures the side of a fruit, and most of the fruits upon which it works are smooth, and the poison does not adhere well. Riley and Howard state these facts as follows:

"On the whole the remedy is one which is a desirable addition to our list, although it will never become so great a success as the application of these poisons for the codling moth, and for two reasons: (1) The egg is deposited and the beetle gnaws preferably upon the smooth cheek of the fruit, where the poison does not so readily adhere, and from which it is more easily washed off. (2) The larva, eating directly from the flap, does not come in contact with the poison as does the larva of the codlin moth."

But the insect gets the poison from the leaves as well as from the fruit. Until recently it has been supposed that the adult curculio, like many other insects, does not eat, and one of our best entomologists stated in 1886 that "Paris green, kerosene emulsion, and other poisons are of no avail against the curculio. He will not eat them." The persistence of certain fruit growers, however, that spraying is effective against the curculio has led to many investigations of the feeding habits of the adult insect. Forbes' experiments* are particularly good. Curculios in confinement ate leaves, flowers and fruits of the plum, leaves of peach, and flowers of rose, honeysuckle and snowball. In view of the fact the insects feed thus indiscriminately, Forbes concludes that it may be "worth while to make the attempt to attract the adult to flowering plants in the orchard, other than the peach, with the hope of poisoning it there (especially late in the season) without using these dangerous insecticides on fruits afterwards to be eaten." Of insects in confinement, fed upon poisoned foliage, some died the second or third day, and others soon followed. The

**Insect Life*, ii. 3 (1887).

following table is an interesting and important one, in showing the effects of sprays of different strengths as compared with wholesome food :

Dates.	No Poison. —12 Insects.	1 lb. to 100 gals. —12 Insects.	1 lb. to 200 gals. —12 Insects.	1 lb. to 300 gals. —22 Insects.	1 lb. to 500 gals. —22 Insects.
May 6.	..	3	2		1
" 7.		1	..	4	2
" 8.		1	2	2	1
" 9.	..	2	3	3	3
" 10.	1	3	1	4	4
" 11.	..	1	..	6	4
" 13.			4	2	5
" 14.		1	..	1	1
Total,	1	12	12	22	21

"All strengths of the poison mixture here killed the beetles feeding on it, the difference being seen in the rapidity with which they took effect. In four days from poisoning, the ratios killed were 42 per cent. in lot two, 33 per cent. in lot three, 27 per cent. in lot four and 18 per cent. in lot five."

The success of the arsenites in combatting curculio on the plum and cherry has led fruit growers to apply them to the peach. This has been particularly true in the "peach belt" of Michigan during the past season. But it was found at once that peach foliage is easily injured by the poison, and this experience has opened again the question of the proper strength of the spray. Cook has published the best experiments in this connection. He finds* that "London purple is more injurious to foliage than is Paris green; and white arsenic—arsenious acid—is more harmful than either. This is doubtless owing to the soluble arsenic which is quite abundant in London purple, and almost absent in Paris green." As peach foliage is especially susceptible to injury he recommends that only Paris green be applied to it.

For economic reasons, as well as to avoid injury to foliage, recent tendency is towards weaker mixtures. It is probable that a pound of poison to 250 gallons of water is strong enough for any use, while for the peach and other trees particularly liable to injury, a mixture of half this strength is best. But the spray should always be fine and it should be driven into the tree with great force. There is some evidence to show that mixtures of equal strength act differently

*Bull. 53, Mich. Exp. Sta.

in different parts of the country. Entomological bulletins from Oregon indicate "that the arsenical mixtures must be used in greater dilution than in the east. This point had already been brought out by California experiments. The Oregon people have found that one pound of London purple to 150 gallons of water will burn the foliage of the apple."* Benjamin Hammond informs the writer that trees near the sea-coast are more liable to injury from the arsenites than those growing in the interior states. But the variation in strength of Paris green and London purple may be so great, and the methods of application so various, that we cannot yet generalize upon this subject.

The time and frequency of spraying for the curculio are still moot points, although it is well established that several applications are necessary. There are several circumstances which complicate the matter. Spraying trees while they are in bloom, although it may destroy some curculios, appears to be fatal to bees, and there is a possibility that it may interfere with pollination. On the other hand, there is some indication that in mid-season the spray is more harmful to foliage than it is earlier in the season. But if the poison is sufficiently diluted no harm can result to foliage. Spraying three or four times at intervals of a week or ten days, or oftener if heavy rains occur, appears to be the proper practice.

4. Desirability of Laws to Control Insect Ravages and Plant Diseases.

There is an increasing demand for legislation designed to check the spread of injurious insects and plant diseases. In America the chief activity in this direction within the past year has been the discussion of measures for the eradication of yellows in the peach. It is evident that all the states in which yellows prevail to a serious extent will soon have radical laws for its control. The Michigan law, probably the first one framed in this country for the purpose of mitigating a particular and specific disease of plants, serves as a model for discussion and enactment. California has a general law directed against "any insect or insects, or the germs thereof" which are injurious to fruit, or "any contagious disease known to be

**Insect Life*, ii. 56.

injurious to fruit or fruit trees." Early in the year litigation occurred in Western New York over the operation of the yellows law, but the outcome of the suit threw no new light upon the disease and established no principles of procedure. The yellows commissioners, authorized by the statute, destroyed trees which they supposed to be diseased and which the owner refused to remove. Upon the refusal of the owner to pay for the labor of the commissioners, the county brought suit for misdemeanor. The defendant contended that the trees in question were not diseased, and in the absence of specimens or the testimony of experts, the jury disagreed. Many witnesses were called to testify to the general nature of yellows, and two or three experts were summoned. But while the court allowed the giving of much general testimony as a matter of general information and education, the case rested upon the condition of the trees in question. It seems necessary to make this explanation, from the fact that the statement has been made that this suit was a victory of those who contend that yellows is a mere condition of the tree, rather than a specific disease, and that it must establish a precedent for the overthrow of yellows laws.

The extraordinary increase recently in ways of combatting insects and plant diseases will enable legislation to be made intelligently and practically, and the next few years must see great progress in wholesale control of these evils. There is certainly no reason why laws for the control of diseases and enemies of crops should not be as salutary as existing laws for the checking of diseases of domestic animals. European states have already taken measures in this direction. France has recently made such a law, aimed at injurious insects, injurious fungi, *et autres vegetaux nuisibles a l' agriculture*, or "other plants harmful to agriculture."

CHAPTER V.

NATIONAL AND EDUCATIONAL INTERESTS.

1. Horticultural Work of the National Department of Agriculture.

Several features of the National Department of Agriculture are of vital importance to the horticulturist. The Botanical Division, particularly in its section of Vegetable Pathology, Division of Entomology and Division of Economic Ornithology and Mammalogy, are all directly related to work in the garden and orchard. The Seed Division also particularly concerns the gardener. The original object of the Seed Division was to distribute rare and new species and varieties, but it has done comparatively little of this work. There is a determination expressed on the part of the Department to increase the usefulness of this Division. Particular efforts are being made to distribute valuable forage grasses and cereals. The general policy of the present administration in this direction is outlined in the following statement from the Secretary of Agriculture :

“The distribution of seeds to experiment stations and agricultural colleges has now become an important part of the work of this Division, and the wisdom of this course is so apparent that the policy of placing seeds of new and presumably valuable plants at the disposal of the officers of these institutions will be sedulously adhered to. From them the Department may reasonably anticipate getting such reports, including such data as the date of sowing or planting, the time of maturing and harvesting, the quantity of seed planted, the amount and quality of the product, the character of the soil and climate, as will enable the Department to arrive at reasonable conclusions as to the relative value of seeds so furnished, so

that we may then be more certain of furnishing to our farmers in the various sections represented by these institutions the seeds best adapted to their wants and most certain to insure them good returns. With a view to securing the best seeds, I have made a *départure* from the methods heretofore in vogue, by engaging the services of a special agent whose whole duty is to visit, personally, different sections of the country, and inspect, as far as possible, the product of seeds offered to the Department, and to look up such as seem to possess specially desirable characteristics. The work done in this line has more than justified the expediency of undertaking it. The results which may be secured by wise dissemination of seeds are of great value. By the substitution of superior varieties for such as have become deteriorated or diseased, and by the introduction of the seeds of new plants, through the cultivation of which the resources and wealth of our people may be largely increased, the producers of this country can not fail to reap very great benefits."

The Division of Gardens and Grounds has in charge the care of the grounds of the Department, the management of the conservatories, and "the introduction, propagation and culture of economic or useful plants, and the distribution of such plants in localities where climatic and other conditions seem favorable to their growth."

"As a main purpose of the Department," through this Division, "is that of introducing, or assisting the introduction, of new or but little known useful plants, it will have served this purpose when these plants have either merited the attention of cultivators or have proved to be failures; in the former case their further propagation is taken up by commercial growers, who can supply all demands, so that the services of the Department are no longer important in that particular plant, and its means can be directed and employed for other purposes of a similar character."

The testing of new varieties was formerly a prominent feature of the work of this Division, but inadequate space has compelled the abandonment of the enterprise. A movement is now making to revive this investigation upon a new site.

But it is through the Division of Pomology that horticulturists hope for most direct results. This Division was instituted August 1, 1886, by the appointment of H. E. Van Deman, of Kansas, as Pomologist. There are now in the employment of the Division, aside from the Pomologist, three clerks and one artist, besides several special field agents who serve as occasion requires. The first work undertaken was to acquaint the horticulturists of the country with the fact of the organization and to secure their co-operation. The Pomologist visited in an official way nearly all of the State Horticultural and Pomological Societies as well as those of a national character.

A list of the names of the members of these societies has been collected and alphabetically arranged, together with all those who have indicated by their correspondence or otherwise their desire to co-operate with this Division. A system of books has been arranged and carried into practice which includes the names of about 12,000 of the leading fruit-growers of the country, and which gives the kinds of fruits and the amount of each grown by the persons named. These names are all arranged by States and counties and reference can be made at once to those persons engaged in the growing of any fruit.

It is the policy of the Division to collect specific information and to publish special bulletins or monographs on the different classes of fruits. Two great opportunities—the neglected horticulture of the South, and the study of native wild fruits—at once presented themselves, and work has been largely in those directions. Bulletin 1, which was published in 1887, contains the most accurate reports obtainable on the subject of tropical and semi-tropical fruits as cultivated in the United States at that time. Bulletin 2 relates to the Russian and other fruits as grown in the extreme Northern States in the year 1887. A monograph is being prepared which will describe completely the wild grapes of North America. This will appear, it is expected, during the coming year. During the summer of 1889, T. V. Munson, of Texas, was commissioned as a special agent of the Department to investigate the wild fruits of the Western States and Territories, and he traveled, in company with Mr. C. L. Hopkins, a clerk of the Division, over 10,000 miles, in the course of the work. Observations were made upon all wild fruits, and a report thereon is to be published in due time.

Much of the office work consists in replying to inquiries regarding the various topics connected with practical pomology, and the naming of varieties of fruits which are sent for identification and study. More than 10,000 specimens are thus examined each year, and the number is increasing. It is the purpose of the Division to secure specimens of all the new fruits, and drawings and water-color paintings are made of them, all of which are preserved as a permanent record in the office. Critical notes are made of every specimen received. The attention of the Division is also directed to investigations in foreign countries and to the importation of such fruits as

will be likely to prove valuable in this country. In pursuance of this idea, within the last year there have been imported from the Phillippine Islands eleven named varieties of the best coconuts grown there, which were received in good condition, and which have been planted in the extreme southern part of Florida. This is the first lot of named coconuts yet introduced into this country. Six named varieties of the best mangoes grown in the vicinity of Bombay, India, were obtained and have been planted at Lake Worth, Florida, where the commoner varieties of mangoes were already succeeding admirably. Steps have been taken to secure the choicest grapes, figs, olives and peaches grown in Southern Europe, in Persia and in Palestine.

The varieties of the kaki or Japanese persimmon, which have been introduced, are almost wholly incorrect as to names, so far as the trees have borne. This is due, in a great measure, to carelessness and ignorance on the part of the Japanese nurserymen, and perhaps to careless handling of the trees after they have reached this country. Recognizing this fact, the Pomological Division has been endeavoring for the last three years to correct the nomenclature of this fruit. Illustrations and descriptions have been obtained from Japan, and correspondence has been undertaken with the best authorities on the subject in that country and in this, as well as with the fruit growers in the southern states and in California. In 1887 these investigations resulted in determining the correct names of three varieties and the result was incorporated in the report of the Pomologist for that year. In 1888 the prevalence of the yellow fever in the state of Florida, from which the largest share of the specimens have been obtained, prevented the continuation of the work in a great measure, so that very little progress was made that year. In the fall of 1889 a very large number of specimens were obtained from all the states in which this fruit grows, and material progress has been made. At least six additional varieties have been thoroughly identified. It seems now quite likely that the nomenclature of this fruit will be in a great measure corrected. There is much difference in the quality and market value. Among the best varieties may be named Yemon, Hachiya, Tane-Nashi, Yeddo-Ichi, Yamato, Hyakume, Daidai Maru and Tsuru. Information has been received that in the

northern part of Japan and Korea there exist native varieties of the persimmon which will endure as great a degree of cold as the wild persimmon of this country, and the Division is now making efforts to secure them.

2. Horticultural Work of the Experiment Stations.

The experiment stations, established under act of Congress, are for the most part completely organized. It is yet too early to expect much original work of a high character, for the enterprise is not yet three years old,* and most of the stations have been obliged to start with unskilled staffs, and in the face of ignorance and misapprehension. Necessarily a conspicuous part of the work so far done has been of a somewhat temporary nature, but it has gratified public desire and has given assurance that activity and enterprise characterize the stations. It is probable that much of this energy of experiment will soon subside, but there will no doubt be a corresponding elevation in the character of work undertaken. There is an unfortunate common misapprehension, which often assumes the form of a carping criticism, that all experiment performed by the stations should be new. It is no part of the national law nor of the opinions of those who have had much to do in shaping the policy of the stations, that all the work should be novel in its character. The stations are created, in the language of the law, "in order to aid in acquiring and diffusing among the people of the United States useful and practical information on subjects connected with agriculture, and to promote scientific investigation and experiment respecting the principles and applications of agricultural science." Because a certain problem has been well investigated in Germany or France is no reason why it may not be studied here, even under similar conditions and applications. Some of the most useful studies are those which repeat old experiments or which afford new illustrations of well known facts. The stations exist primarily to instruct the farmer, not to advance science in the abstract. When it so happens that the experimenter can afford useful instruction and at the same time add a new law or fact to the sum of knowledge, he

*The Hatch bill was signed by President Cleveland on March 2, 1887.

has attained his highest privilege, but the greater part of investigation must necessarily fall short of this. Except in matters of general science, the investigations of European students possess little or at most indirect value to the American farmer. The work is accomplished under conditions and upon plants which are unfamiliar; and it is also a fact, however much it may be deplored, that the remoteness of the experimenter usually curtails interest in his work. A German experiment, for instance, is worth much more to the American farmer when repeated in this country than when published first hand. Moreover, there is no means by which the detailed work of foreign investigators can be placed before the mass of our farmers. The researches are too heavy for the agricultural press, and it is considered impolitic for the experiment stations to issue them as bulletins. All these facts appear to be overlooked by various scientific journals which persist in comparing all work with European standards and in inveighing against all experiment which is not new. A certain experimenter recently thought it legitimate to make various researches because "there have been no general inquiries in this country into the exact effects of these conditions, or their importance to the cultivator;" whereupon an editor of a scientific journal remarked, "Well, what of it? There have been in other countries."

In short, the work of European investigators is of chief use, in America, to the experimenter rather than to the farmer, and it is the privilege of the experimenter to make whatever use of it that seems fit. It may suggest work for himself, or he may supplement it. Here arises the question as to how far the experimenter shall quote volumes and authorities, in his bulletins, for similar work done elsewhere. It is doubtful policy to load a popular bulletin with references unintelligible to the cultivator; it seems better to make a simple statement of the foreign results, if it is thought best to discuss them at all. Many bulletin-makers write as if their audiences were co-workers rather than farmers. Yet the whole matter of collation with foreign experiments is an open question, and it may solve itself if attention is once called to it. There are some bulletins which are of necessity technical and interest a small audience; in these the technicalities of composition are necessary, for their matter is mostly new in science. But the mass

of bulletins are popular, and it would seem as if they demand different treatment; and, in fact, the necessity for comment in this connection is not suggested so much by the bulletins as by the attitude of critics.

Another common misapprehension of the proper sphere of experiment station work is the supposition that all the work of the stations must be experimental in its character. The stations exist in order "to aid in acquiring and diffusing" practical information, *and* to "promote scientific investigation and experiment." It is therefore legitimate for the station, now and then, to collate particular matter from reliable sources, if the matter is of such a character as to afford "useful and practical information on subjects connected with agriculture."

About twenty-five of the experiment stations have a horticulturist on the staff, and most of these officers have appeared before the public in bulletins. The work which they have done covers a wide range of important subjects, but the favorite line of investigation appears to be the ordinary testing of varieties. This is the cheapest and least satisfactory work which the horticulturist can do, unless he has some ulterior aim. To test varieties for the purpose of familiarizing himself with the species in hand that he may discover its laws of variation, or to make tests in order to determine what varieties are adapted to particular purposes or regions, are high aims of experiment, but to test simply because new varieties are put upon the market is quite the reverse. To be sure, the horticulturist must grow new kinds to a great extent as a matter of general information, but it is doubtful if his special work can profitably lie in this direction. Varieties are so largely influenced by soil, climate and treatment, are often so variable in themselves, and their values are so largely determined by the purposes for which they are grown, that the experimenter can not often hope for much satisfaction from his labor, particularly if he endeavors to study many species. At the present time, the judgments of commercial growers are worth more than those of experimenters.

Many of the horticulturists have felt the inadequacy of tests of varieties, and it was largely this feeling which called together the horticulturists of the stations at Columbus, Ohio, last June. It was then determined that the variety tests of all the stations should be collated by the Office of Experi-

ment Stations of the National Department of Agriculture, and be issued by that office as occasional bulletins. This action, by combining many reports, will add value to the work of the stations, while it does not prevent the officer from publishing his independent results. It was decided, also, that uniformity in names of varieties should be secured, and inasmuch as no organization had undertaken reform in the nomenclature of kitchen garden vegetables, a committee was appointed to consider the matter. The American Pomological Society has prosecuted a vigorous reform in the nomenclature of fruits, and the Society of American Florists has resolved to make the endeavor to control the names of florists' plants. It now remains for some organization to extend the agitation to ornamental trees and shrubs. The committee appointed by the station horticulturists assert that

"Brevity, accuracy and good taste in the naming of vegetables are perfectly compatible with the purposes of trade, and it therefore solicits co-operation in this work, not only from all writers upon horticultural topics but also from all dealers in garden seeds and supplies. A name is bestowed upon any plant solely for the purpose of designating it; it is not the province of a name to describe the plant. All description is properly a part of the text. This description should present a characterization of the variety, rather than a mere list of adjectives intended to catch the eye. The committee desire to suggest that a variety never be described under a name which is accepted as a synonym; if the synonym is used as a leader, it should stand only for the purpose of making a reference to the proper name; as, Ivory Ball—see *White Apple*."

The following rules were formulated, and the Office of Experiment Stations has distributed them to the seedmen and the press of the country:

1. The name of a variety should consist of a single word, or at most, of two words. A phrase, descriptive or otherwise, is never allowable; as, *Pride of Italy*, *King of Mammoths*, *Earliest of All*.
2. The name should not be superlative or bombastic. In particular, all such epithets as *New*, *Large*, *Giant*, *Fine*, *Selected*, *Improved* and the like should be omitted. If the grower or dealer has a superior stock of a variety, the fact should be stated in the description immediately after the name, rather than as a part of the name itself; as, "*Trophy*, selected stock."
3. If a grower or dealer has procured a new select strain of a well known variety, it shall be legitimate for him to use his own name in connection with the established name of the variety; as, *Smith's Winnigstadt*, *Jones's Cardinal*.
4. When personal names are given to varieties, titles should be omitted; as, *Major*, *General*, *Queen*.

5. The term *hybrid** should not be used, except in those rare instances in which the variety is known to be of hybrid origin.

6. The originator has the prior right to name the variety; but the oldest name which conforms to these rules should be adopted.

7. This committee reserves the right, in its own publications, to revise objectionable names in conformity with these rules.

A very important movement in connection with the experiment stations is the organization in the National Department of Agriculture of an Office of Experiment Stations. The duty of this office, as outlined by the Secretary of Agriculture, is "to indicate lines of inquiry for the stations, to promote the co-ordination of their work, to furnish them needed advice and assistance, and to collate and publish the results of their experiments. To this end it conducts a large and increasing correspondence relating to the scientific, administrative, and general interests of the individual stations and the enterprise as a whole. Its representatives visit stations, agricultural colleges and kindred institutions. It collect statistics and other information regarding agricultural science; compiles results of inquiry, past and present, in this country and in Europe, which are greatly needed and earnestly called for by the station workers and others interested in agricultural science; and puts the result of station work in practical form for general distribution in farmers' bulletins."

In general, the Secretary of Agriculture regards "the development of the experiment station enterprise in this country as a noteworthy illustration of the readiness of the American people to grasp and to utilize new and valuable ideas. Beginning only fourteen years ago, it has grown out to the farthest limits of the land, enlisted the best colleges and universities and the ablest investigators, and secured both state and national resources for its maintenance. It now employs nearly four hundred workers 'to promote agriculture by scientific investigation and experiment, and to diffuse as well as increase the knowledge which improves farm practice and elevates farm life. It has the favor of a great army of practical farmers, to whom it has already brought substantial benefits. The experience thus far gained evinces the wisdom of Congress in distributing the work throughout the country

*A *hybrid* is the product of true species. There are few, if any, instances of true hybrids among common garden vegetables. The union of varieties gives rise to a *cross*.

where it may be adapted to the wants of the various sections, and placing it in connection with institutions of learning which are, in general, laboring faithfully to fulfill the trust imposed upon them. Crudity and mistakes are here and there apparent. But the general effort of the stations toward the greatest usefulness, the wise action of the Association of American Agricultural Colleges and Experiment Stations, the cordial support of the people, state legislatures and Congress, and the practical results already obtained, imply that the national government has made no mistake in undertaking this enterprise on a larger scale than has been attempted elsewhere in the world."

3. Irregularities in Weights and Measures.

The increase in shipment and interchange of horticultural products is constantly bringing into greater prominence the irregularities and variations in commercial weights and measures. It is time that uniformity were demanded in the various States. The weights of a bushel of produce often differ much between adjoining States, and growers multiply the confusion by shipping in packages of almost every description and capacity. It is probably not desirable that the style of package for any fruit shall be uniform throughout the country, for it is found that some markets demand certain fashions; and it is also true that conditions of shipment sometimes determine to a great extent the character of the package. Yet all interests would be subserved if packages were to hold the quantity which they are said to hold, if a peck basket were to hold eight quarts and a half-peck four quarts; and there is also necessity for a general uniformity in shape, within certain geographical limits, yet leaving the details to the taste or necessities of the grower. The fruit exchanges which are now springing up will no doubt enforce uniformity, to a great extent, for substantial uniformity within State limits is in many ways desirable.

The old perplexity concerning the size of the berry quart is still unsettled, and will probably so remain until a national standard is promulgated. It is a singular anomaly that berries are usually sold by liquid measure. The wine or liquid

quart contains $57\frac{3}{4}$ cubic inches, while the dry quart contains $67\frac{1}{5}$. Many local organizations have attempted to inaugurate uniformity in the berry quart, and have always in their first efforts, so far as the writer is aware, recommended the use of the full or dry quart; but some have abandoned their efforts, and at least one has become so far discouraged as to adopt wine measure, for its "efforts to obtain uniformity on the dry measure box have been a failure." There are a number of difficulties attending the adoption of uniform quarts. The greatest perplexity comes from the settling of berries in shipment. If the box is designed to hold a full quart when level full, the berries will need to be heaped to provide for settling. In this case the grower gives the market more than he is required to give. It is therefore urged that the wine or "snide" quart is the fairer one, for when heaped it holds about a full quart. This may be true when long shipments are made, but those within easy reach of market do not need to heap their boxes to any extent, and these persons therefore sell under measure. And the mere fact that boxes of different sizes are in the market, often standing side by side, fosters an unpleasant impression in the mind of the customer. The remedy for this evil, and of numerous others, of which this may serve as a type, is the measuring of shrinkable produce by weight. The customs in the Pacific States can be profitably studied in this connection.

The whole subject of weights and measures in reference to produce needs correction by Congress. Movements have already been made in this direction. The New Jersey State Board of Agriculture recently sent a committee to Washington, for the purpose of investigating the question of a national standard, under the leadership of the late Dr. George H. Cook. Dr. Cook reported that he "was surprised to find that there had been no legislation whatever on the question by our general government." In certain cases, Congress has fixed the weights of produce. "For instance, the customs-revenue officers, in fixing the amount of duties upon imported grain, are directed to allow 60 pounds per bushel for wheat, 56 for corn and rye, 48 for barley, 32 for oats, 60 for peas and 42 for buckwheat."*

*J. R. Dodge, Rep. Com. Agr. 1877, 197.

have established by custom, definite weights for certain commodities. Beyond these limits, however, the government appears never to have established any uniformity in measures.

4. *The National Flower Discussion.*

The most prominent discussion of the year upon matters pertaining to plants has been upon the selection of a national flower. The movement appears to have begun with an article from Jean Kincaid in the *Boston Daily Globe*, May 13, 1888, since which time almost the entire press of the country has given the discussion prominence. Mr. Prang has issued an artistic souvenir with various native flowers in colors, and asks for votes upon the choice of a national emblem. This vote is to be announced at the opening of the year 1890.* Other novel plans of awakening interest in the movement and securing opinions have been devised. There appears to be less agitation concerning the feasibility or necessity of adopting a national flower than upon the selection of one. The fact appears to be too often overlooked, although it has often been expressed, that national flowers are the product of events or of peculiar fitness in the plant. There are neither of these incentives to the choice of a flower for America. If an emblem is to be selected *de novo* it should possess characteristics of the nation while at the same time it conforms to particular requirements. Such a plant does not exist. If we must have the emblems, they must appear as the representatives of particular regions or particular events. *The Horticultural Art Journal* suggests that each state select its own. This simplifies the problem by extending it, and places it upon the basis of the coats of arms of the states. It may be pertinent to inquire, in the present issue, who is to make the choice. A committee on the national flower, of the Society of American Florists, declined to assume the responsibility: "Your committee report that they have given much consideration to the subject assigned to them, without being able to recommend any particular flower. There are so many candidates for favor and such a diversity of opinion upon the

*Of these votes, 70 per cent. favored the golden-rod, 16 the Mayflower, and the remaining 14 per cent. were divided among the daisy, laurel, dandelion, sunflower and some others.

subject that it is impossible, at the present time, to select a flower with any probability that it will be accepted by the people of the United States with any degree of unanimity. It is better, in the judgment of the committee, to leave the matter open for discussion."

Numbers of plants have been pressed for public favor. The conspicuous ones are golden rod, Indian corn, apple, mountain laurel (*Kalmia*), Mayflower (*Epigæa*), water lily, magnolia, aster. The features which a national flower should comprise are admirably stated in *The American Garden* for September by George W. W. Houghton, in support of the apple blossom :

1. Preferably it should be the flower of a native plant, though not necessarily, for our population is the result of transplanting, and an imported flower, providing it has been thoroughly Americanized, would have a certain appropriateness.

2. It should be generally distributed throughout the country, so that citizens of every state might feel that they had a part in it; and it must be common and familiar to all.

3. It should preferably suggest utility as well as beauty, in order to correctly characterize the prevailing spirit of our age, and of our country in particular.

4. It should be as little variable as possible in form and color, so that either will be suggestive.

5. It should neither be so large that it cannot be worn in the button-hole or in a lady's bonnet, nor so small that its form is unfamiliar. On the latter score I would rule out all composite flowers.

6. Its form should be distinct and characteristic, so that it may readily be recognized when used for decorative purposes, without the necessity of color, and even when simplified to the merest outline.

7. It should have some sentiment about it; and, to fulfill this condition, it is highly desirable that it should have an agreeable odor. Without this attribute of sentiment it is impossible that it should take any hold on the public.

5. *Missouri Botanic Gardens.*

America has at last the opportunity to possess a great botanic garden. The magnificent fortune of the late Henry Shaw of St. Louis has been left to the maintenance and augmentation of the gardens which he established many years ago. Provisions of the broadest and most liberal nature have been made, and the trustees are men of sound business worth and are fully aware of the responsibility which falls upon them. The fortune which falls to the support of this garden "has been appraised," writes *Garden and Forest*, "at nearly \$3,000,-

ooo, and produces a net income of about \$50,000 ; but as a large part of Mr. Shaw's property is invested in unimproved real estate within the city limits of St. Louis, the income of his estate may be expected to increase enormously with the growth of that city ; and Professor William Trelease, the newly appointed director, will, in all probability, soon find himself at the head of a better endowed establishment than any other of its kind which has ever existed. There is no botanic garden in the world, with the exception of that at Kew, where the annual expenditures are not far from \$100,000, which enjoys an income of anything like \$50,000, and a vast amount of good and useful work can be accomplished every year with that sum of money." This institution will be more than a garden. It will in time comprise a great botanical museum, with a comprehensive herbarium, of which the inestimable collections of Engelmann form a nucleus. It will also become a great educational center where botany and all its correlatives will be taught. In short, there appears to be every reason to expect that this will in time become the botanical center of the new world.

The horticultural features of this great project are boldly drawn. It is to be a school of practice as well as study. It will afford facilities for the training of gardeners.

"In accordance with the intention of its honored Founder, the Trustees of the Garden propose to provide adequate theoretical and practical instruction for young men desirous of becoming gardeners. It is not intended at present that many persons shall be trained at the same same time, nor that the instruction so planned shall duplicate the excellent courses in agriculture now offered by the numerous State Colleges of the country, but that it shall be quite distinct and limited to what is thought to be necessary for training practical gardeners."

Garden scholarships have been established, with the following aims and provisions :

"Scholarships, not exceeding six in number, will be awarded by the Director of the Garden, prior to the first of April next. In case the entire number are not then awarded, the remainder will not be awarded until the corresponding period of the following year, and vacancies which may subsequently arise will be filled annually, after published announcement."

The pupils who are fortunate enough to secure these scholarships "will be lodged in comfortable rooms in a spacious dwelling adjoining the Garden, under the charge of the Head Gardener or some other competent person. It is not the intention of the Trustees to furnish table board, but good board can be obtained in the lodging house or elsewhere, at the usual cost.

The lodging house will include a reading-room supplied with the more valuable horticultural and agricultural papers, and also with a small but standard collection of books on the same subjects, of which the pupils will have free use. So far as possible, the surroundings of pupils will be made home-like, and without assuming any responsibility for their behavior, an effort will be made to subject them to influences calculated to insure for them gentlemanly manners and habits of industry and investigation.

“During the first year of their scholarship, garden pupils will work at the practical duties of the Garden nine or ten hours daily, according to the season, the same as regular employees of the Garden, and will also be expected to read the notes and articles referring to the subject of their work, in one or more good journals.

“In the second year, in addition to five hours' daily work of the same sort, they will be given instruction and will be required to do thorough reading in vegetable gardening, flower gardening, small-fruit culture, and orchard culture, besides keeping the run of the current papers.

“In the third year, in addition to five hours of daily labor, they will be instructed and given reading in forestry, elementary botany, landscape gardening, and the rudiments of surveying and draining, and will be required to take charge of clipping or indexing some department of the current gardening papers for the benefit of all.

“In the fourth year, besides the customary work, they will study the botany of weeds, garden vegetables and fruits, in addition to assisting in the necessary indexing or clipping of papers, etc., and will be taught simple book-keeping, and the legal forms for leases, deeds, etc.

“The course for the fifth year, in addition to the customary work, will include the study of vegetable physiology, economic entomology, and fungi, especially those which cause diseases of cultivated plants; and each pupil will be expected to keep a simple set of accounts pertaining to some department of the Garden.

“In the sixth year, in addition to the manual work, pupils will study the botany of garden and greenhouse plants, of ferns, and of trees in their winter condition, besides the theoretical part of special gardening, connected with some branch of the work that they are charged with in the Garden.

“From time to time, changes in this course will be made, as they shall appear to be desirable, and the effort will be made to give the best theoretical instruction possible in the various subjects prescribed; but it is not intended to make botanists or other scientific specialists of garden pupils, but, on the contrary, practical gardeners.”

“To the end that garden pupils shall be repaid for their services to the Garden, and that the absence of pecuniary means need not deter any young man from obtaining such training as is contemplated, each regularly appointed garden pupil holding a scholarship shall be entitled to the following wages, payable in equal installments at the end of each fortnight: For the first year, \$200.00; for the second year, \$250.00; and for each year after the second, \$300.00; together with plain but comfortable lodgings convenient to the Garden.”

CHAPTER VI.

CONVENTIONS OF NATIONAL SOCIETIES PERTAINING TO HORTICULTURE FOR THE YEAR 1889.

1 American Pomological Society.

The 22d session of the American Pomological Society was held in Ocala, Florida, February 20, 21 and 22. The convention was well attended and the papers and discussions throughout were elevated and instructive. The Report of this meeting is the largest yet issued by the Society, and is in some respects the best. It is particularly full upon the citrus and other sub-tropical fruits. Indeed, it is the best contribution yet made to the knowledge of our Southern horticulture and the meeting is one of the most important events in the neglected yet growing horticulture of the Gulf States. The leading papers and discussions of the volume are as follows:

- President's Address—Prosper J. Berckmans.
- Cross-Fertilization—J. C. Neal.
- Unsolved Problems in Pomology—E. S. Goff.
- The Plum Curculio—C. V. Riley.
- Results of Recent Experiments in the Treatment of Vine Diseases—
B. T. Galloway.
- The Chemistry of Peach Yellows—E. F. Smith.
- Botanical Names—D. W. Adams.
- Reserve Food Materials in Fruit Trees and Shrubs in Mid-Winter—
B. D. Halsted.
- Gluts, their Cause and Remedy—Barnett Brothers.
- The Packing of Fruit for Market—P. M. Augur.
- Honesty in Packing Fruit—E. Williams.
- Fruit Marketing and Fruit Exchanges—A. M. Brown.
- The Delaware Fruit Exchange—Wesley Webb.

- Report of Sub-Tropical Committee—A. H. Manville, J. C. Neal, H. G. Hubbard, George L. Taber.
 Tropical Fruits—E. N. Reasoner.
 Varieties of the Sweet Orange—E. H. Hart.
 Orange Growing in Florida—C. F. A. Bielby.
 The Orange Industry in the United States, from a Commercial Standpoint—George R. Fairbanks.
 The Lemon in Florida—H. S. Kedney.
 The Minor Citrus Fruits—T. W. Moore.
 The Fig Industry in Florida—Harrison Reed.
 The Fig and the Pomegranate—D. Redmond.
 The Pineapple—James H. White.
 Pineapple Culture in Florida—G. Loutrel Lucas.
 Ornamental Palms—Theo. L. Mead.
 The Diospyros Kaki—B. F. Livingston.
 The Grape in Florida—E. M. Dubois.
Vitis vinifera in Florida—H. Von Luttichau.
 Strawberry Growing in Florida—Stephen Powers.
 Peach Growing in Florida—George L. Taber.
 The Apple and Pear in Florida—J. H. Girardeau.
 The American Pomological Society, and its Rules of Pomology—T. T. Lyon.
 Judging Citrus Fruits—H. E. Van Deman.
 Testing and Introducing New Fruits—C. L. Watrous.
 Commercial Apple Orchards of Ontario—L. Woolverton.
 Cherry Growing in the Mississippi Valley—J. L. Budd.
 A Promising New Fruit from the Plains [*Prunus pumila*—Charles E. Bessey.
 Fruit Culture in California—D. B. Wier.
 The Improvement of our American Grapes—George W. Campbell.
 Nut Culture—H. M. Engle.

The following new fruits were discussed :

Yellow Transparent and Murphy Apples ; Lucretia, Minnewaski and Erie blackberries ; Crandall currant ; Triumph Gooseberry ; Lutie, Jewell, Berckmans and Green Mountain Grapes ; Peen-to peach ; Idaho pear ; Kelsey and Satsuma plums.

The State reports, though comparatively few, are valuable. The Catalogue of Fruits, which is one of the features of the transactions of this Society, is invaluable.

The next meeting will probably be held in Chicago.

2. Society of American Florists.

The fifth annual convention of the Society of American Florists convened in Buffalo, New York, on August 20th, and continued in session until the 23rd. The meeting was the best in the history of the society. Several important

topics were reported upon by committees. The committee on express rates on plants reported the adoption by leading express companies of the following "uniform schedule of rates for plants of all kinds:" "When packed close in boxes or crates, regular merchandise rates; when packed open, double rates; when not so packed, single rates." A committee appointed to consider the status of duty on bulbs was "continued with instructions to use their best endeavors to have the duty on bulbs rescinded."

A committee upon "exaggerations in illustrated catalogues" made the following report, which, after much discussion was "accepted as read and referred to the executive committee for final action, with power to act:"

1. "That catalogue makers be invited, before publishing a cut of any new flower, plant, fruit, or vegetable, to submit such cut to the Executive Committee of the Society of American Florists, or to any three members of that committee, together with a specimen of the original flower, fruit, etc., as the case may be, for comparison; and that the said committee or sub-committee be authorized, in the name of the Society of American Florists, to accept and approve such cuts as they find true to nature, and the publisher be given certificates of such approval, with liberty to print the same in his catalogues."

2. "That all publishers of illustrated catalogues be invited to send in specimen copies for competition at our annual exhibitions; and that a certificate of highest merit be given to the best catalogue submitted, and a special certificate of merit be given to every catalogue that is found to be quite free from false, exaggerated, and misleading illustrations."

3. "That when the attention of the committee is called to any catalogue which continues persistently to show false and misleading cuts, it shall be the duty of the committee to call the attention of the publisher to the occasion for complaint, and if he fails or refuses to remove the offending cuts then to bring the matter before the next general convention so that the name of such recalcitrant publisher may become generally known."

The committee on uniformity in pots reported progress in the lines of its former efforts. Several manufacturers are now making the standard pots. These pots are graded entirely by inside measurements, the depth and breadth being equal, and they are rimmed or shouldered.

A gratifying feature of the exhibit at the convention was a number of herbariums, presented in competition for a one hundred dollar prize offered by Peter Henderson. The committee on herbariums state that "of all the exhibits in the building there is not one which has received so much attention and afforded so much pleasure as this one. This goes to

show that the work of the society need not be confined to the narrow limits of commercial floriculture.”

The Florists' Hail Association of America, which is a section of the Society of American Florists, met August 21st. The following extracts are made from the secretary's report :

“After over two years of practical working, we are ready to assert that to-day no more perfect system of insurance exists on the American continent than that adopted by the Florists' Hail Association of America. One hundred and forty-two persons having banded themselves together for the purpose of securing themselves against loss by hail, find that after paying all losses and expenses from June 1, 1887, to August 12, 1889 (except the salary of the secretary for the past year and a small bill for printing), they have a fund of \$561.59 in hand. In addition to this the membership fee has accumulated a reserve fund of \$743.07, after deducting \$76.25 which has been refunded to those who subscribed towards the guarantee-fund and afterwards became members of the association. The result has been secured to the members of the Florists' Hail Association by the payment of six cents per hundred square feet of double thick glass, and eight cents per hundred square feet of single thick glass. The membership fee having been placed at interest, has this year brought to the assessment fund of the association, the sum of \$33, as will be seen by the treasurer's report.

“The total amount of glass now insured is 1,327,240 square feet, of which 734,386 square feet is double thick, and 592,854 square feet is single thick. The total assessments collected upon the same have been \$914.37, and the total membership fees \$819.32. No assessment other than that paid by members upon joining has been levied, and it still remains a question of the future, how often it may be necessary to levy the same. The glass insured is located in twenty-two states and Winnipeg, Manitoba, the states of Georgia, Alabama and Dakota having been added to those reported last year.” \$160.09 was paid during the year for glass broken by hail.

“An effort on the part of your secretary to locate the hail belt has met with the following results: So far as he has been able to learn, hail has fallen during the past year at Flatbush, N. Y.; Short Hills, N. J.; Spring Valley, N. Y.; Chicago, Ill.; St. Ignace, Mich.; Peoria, Ill.; New Hanover Co., N. C.; Liberty, Mo.; Larned, Kas.; Montclair, N. J.; Atlanta, Ga.; Bell Co., Tex.; Lake Forest, Ill.; Danville, Va.; La Crosse, Wis.; Independence, Mo.; Morrison, Ill.; Kansas City Mo.; City of Mexico, Mex.; Marion, Ia.; Abilene, Kas.; Bonner Springs, Kas.; Oconomowoc, Wis.; Cedar Rapids, Ia.; Oswego, N. Y.; St. Albans, Vt.; Martinsburgh, W. Va.; Great Bend, Kas.; Montreal, Can.; Clinton, Ia.; Upper Sandusky, O.; Pembina, Dak.; Lynn, Mass.; Prarie du Chien, Wis.; Lake Geneva, Wis., and Denver, Col. From Montreal to Mexico, from Denver to St. Albans, the florist's fickle structure is as liable to be crushed by hail as to be burned by fire.”

A National Chrysanthemum Society was organized as a branch of the Society of American Florists. The objects sought by this organization, as previously outlined by Mr.

Thorpe,* are as follows: 1. The supervision and discrimination to be given to seedlings before they are distributed. 2. The consideration and selection to be given to collectors for all purposes. 3. The best method for producing the best specimens of all kinds and for all purposes. 4. The supervision, as far as possible, over those distributing chrysanthemums, so as to insure their being true to name. 5. The information and establishing of societies in all cities, towns, and villages where one does not already exist. "The societies should also publish a catalogue of all worthy existing varieties, properly classed and accurately described, and give the raiser's name and year of introduction where known. This should appear annually in future." †

The Florists' Protective Association was also organized. "Its object shall be the protection of its members from the designs of dishonest persons."

A prominent discussion before the Society, and one which has been prolific of comment in the press, is the matter of technical education for florists. There is thought to be no place in America where florists can acquire at the same time an education and a trade. The discussions abound in cities, but they may eventually crystallize into some definite and practicable venture. One of the cardinal mistakes in this connection is the supposition that the first requisite to a superintendent or director of a florists' school is a technical and comprehensive knowledge of floriculture. If education is desired, the first requisite is ability to teach. Very few of the florists connected with our technical schools possess in high or even adequate degree this prime requirement. The ideal teacher is, of course, the one who combines ability to teach with skillful handicraft, but the former is the more important. The best teachers are those who fire the ambitions of their pupils, and it often happens that the pupil outstrips the master. To possess knowledge is one thing; to be able to impart it attractively is quite another.

Many important discussions upon matters connected with the trade were conducted, and several attractive papers were read. A list of the papers follows:

Roses—W. C. Barry, followed by much discussion.

The Elevation of Our Business—Robert Craig.

*Am. Florist, IV, 255.

† Am Florist, V, 68.

Education—H. H. Battles.

The Establishment of an Experimental Garden—John Thorpe.

Useful Summer Blooming Flowers—A. E. Whittle.

Horticultural Exhibitions—Edwin Lonsdale.

On the Making and Application of Heat in Greenhouses—J. S. Williams.

Landscape Gardening [in high colors]—William McMillan.

Orchids, the Natural Habitat of the Leading Varieties—I. Fostermann.

The next meeting of the Society is to be held in Boston, August 19 to 22.

3. *American Association of Nurserymen.*

The fourteenth annual meeting of the American Association of Nurserymen was held in Chicago, June 5 and 6. The convention was an important one, and the discussions were various, brisk and valuable. The volume of proceedings lacks only a good index to make it an invaluable contribution to our horticultural literature. The papers presented are as follows :

Suggestions for the Improvement of the Nursery Business—S. M. Emery.

Plums and Plum Culture—S. D. Willard.

The Grape Industry in Missouri—George E. Meissner.

Commercial Fertilizers for the Nursery—Thomas Meehan.

Packing and Shipping Nursery Stock—N. H. Albaugh.

The Nursery Outlook—Franklin Davis.

Forestry—C. J. Carpenter.

Succession of Forest Growths—Robert E. Douglas.

Reform in Names for Fruits—H. E. Van Deman.

Growing Vines and Stocks—Silas Wilson.

Greenhouses—Peter Henderson.

Improved Implements—L. G. Bragg.

Boxing Trees Free of Charge—H. S. Anderson.

Winter Protection of Nursery Stock—Z. K. Jewett.

New Grapes—George W. Campbell.

Nomenclature—John J. Thomas.

Newer Varieties of Peaches—George B. Thomas.

Notes on Strawberries—M. Crawford.

The Irresponsible Salesman—T. C. Ferrell.

Classification of Nursery Freight—William Pitkin.

Managing Nursery Agents—William Pitkin.

Nurserymen and Local Horticulture—Anthony Lamb.

In connection with this Association, *The American Florist** makes the following statement concerning express rates :

“Hon. S. M. Emery, Chairman of the committee appointed by the American Association of Nurserymen for the purpose of securing lower rates on express lines, reports to Secretary Charles A. Green that a new classifi-

* v. 100.

cation has been agreed upon which amounts to a reduction of 20 to 25 cent. on all express lines on all shipments of trees and shrubs boxed or baled. Such packages are now classed with produce."

The organization has previously secured a reduction in freight rates.

The next meeting of the Association will convene on the first Wednesday in June, 1890, in New York City.

4. *Association of American Cemetery Superintendents*

The third annual meeting of this organization was held in Detroit, September 17, 18 and 19. The meeting was a successful one, both in attendance and in the character of papers presented.

The work of this association is largely in the lines of ornamental gardening, as applied to cemeteries, and is therefore germane for record here. In fact, every horticulturist who hopes to follow closely the progress of his art in its highest phases must familiarize himself with the discussions of this organization. The following papers, of horticultural interest, were presented at the last meeting :

- The Ideal Cemetery Superintendent—Frank Higgins.
- How Cemeteries will be Benefited by our Association—W. A. Morrow.
- What Lawn Seed is the Best?—B. D. Judson.
- Cemeteries within City Limits—A. W. Blaine.
- What Trees and Shrubs are the most Desirable for Cemetery Decoration—J. G. Barker.
- Responsibilities of Cemetery Superintendents—T. McCarthy.
- Landscape Gardening in Cemeteries—F. Eurich.
- Monuments and Headstones—O. C. Simonds.
- Lawns—N. C. Wilder.
- Roads—J. W. Lovering.

The next meeting will be held in Boston during the session of the Society of American Florists.

5. *The Northwestern Cider and Vinegar-Making Association,*

Convened in Chicago, December 17 and 18, with a good attendance. The following account of the meeting is adapted from *The Prairie Farmer*, of December 28th :

Mr. Cary presented samples of pure apple cider, both still and sparkling, not fortified as stated, in any respect, but solely from the juice of particular varieties of apples, containing the constituents necessary to produce the best results.

A paper on The Importance of the Cider-Making Industry to Horticulturists, by Mr. A. C. Hammond, advocated the necessity of producing a pure article.

Mr. C. H. Stewart, in his paper on Prohibition as it Affects Cider, advised that cider should be kept sweet. In the discussion that followed by the members, it was advocated that the artificial addition of acids was adulteration; several members agreed that there was more danger to cider-makers from adulteration and imitation-cider than from the effects of prohibitory laws—that no cider can be kept for a length of time unless there is some conversion into alcohol. The bread we eat contains alcohol. Prohibition helps the sale of pure cider. These are some of the expressions showing the general feeling.

In answer to the question, "How Can Western Cider-Makers Improve Their Product," Mr. A. R. Whitney, the veteran orchardist of Northern Illinois, replied: Have good apples, make good cider, put it in good packages and take care of it.

Mr. Hilliard, the well known orchardist of the Alton, Ill., district, said that prohibition states want dry cider. He used last season salicylic acid and found it satisfactory for winter and spring use. For summer it is better to ferment the juice down somewhat. Has had no difficulty in shipping cider into prohibition states.

Vinegar tests were taken up, and the rest of the session was occupied in testing samples and the composition of the several tests.

Mr. F. C. Johnson, on vinegar-making, held that first fermentation should be slow. Work it in barrels in a warm room, of even temperature. When ready for market, rack it off with siphon. The keeping-room should be dark, using artificial light for examination. About eighteen months are necessary to produce good vinegar, by this plan.

At the Wednesday afternoon session Mr. H. M. Dunlap, upon the question of a vinegar law, said it should be very carefully framed, and when introduced every manufacturer should remind the member of the legislature for his district to vote in favor of the law.

Mr. F. C. Johnson advocated the awakening of public sentiment in favor of a law, by carefully-written articles in the agricultural press.

Mr. Periam, of *The Prairie Farmer*, held that concerted action was necessary to success, and that food-adulteration generally might well be included in the law. Also that the carrying out of the act should be by a commission of inspectors appointed by and paid by the state; else the law would be a dead letter.

Mr. Incher said in Ohio the dairy and food-commissioners had charge of vinegar under the law. In Michigan the law was similar to that of Ohio, but, because no commissioners were appointed to look after the matter, the law was a dead letter. The matter was fully argued by other members, and a committee was appointed to formulate a bill to be presented to the Legislature. The committee are: W. H. Schuyler, C. C. Bell and H. M. Dunlap.

The next meeting will be held in St. Louis, on the third week in December, 1890.

6. *American Seed Trade Association*

Met at Washington, June 11 and 12. The meeting was well attended. The business of the Association is wholly of a trade character. A uniform disclaimer of responsibility in selling seeds was adopted. The next meeting will be held in June, 1890, in Saratoga, N. Y.

PART II

CHAPTER VII.

ANNALS OF PLANTS.

I Introductions of 1889.

A LIST OF THE FRUITS, VEGETABLES AND ORNAMENTAL PLANTS
INTRODUCED INTO AMERICAN TRADE DURING THE YEAR.

The following list is a record of the names introduced to American trade and commerce during 1889. There has been no attempt whatever to determine synonyms nor to revise names; in fact, several names which are known to be synonyms for older plants are admitted. The list is simply a record, not a systematic collocation. Proofs of the list have been sent to many leading dealers and growers, and the list is now submitted with the confidence that it is sufficiently complete and accurate to constitute a historical record. It cannot be hoped that there are no omissions, nor that absolute accuracy of date of introduction has been secured in every instance. It is impossible to determine upon the date of introduction of many things. They have often been introduced privately, distributed among friends, and have thus found their way into commerce several years before they were formally introduced to the trade. Some have been offered in one year, and yet the stock was so limited that they were really not introduced until the following year. This is the case with the chrysanthemums marked 1890; they were held back because of "scarcity of the stock." In some cases well-known plants have been reintroduced from their native countries. Some which have long been known in private collections are now first offered for sale. Novelties offered by foreign dealers have been excluded from the present volume.

- Achillæa serrata, The Pearl. *U. S. Nur.*
 Aconitum Japonicum. *U. S. Nur.*
 Aganisia tricolor. South America. *Saul.*
 Agave. A variety of garden sorts, from south Europe. *Reasoner.*
 Albuca, sp. Natal. *Reasoner.*
 Amaryllis crubescens. Mexico. *Horsford.*
 Anemone Hallerii. *U. S. Nur.*
 Aphelandra chrysops. W. Indies. *Saul.*
 Apple. The first eleven entries, all Wisconsin seedlings and well tested,
 were introduced in 1889 by *Wm. A. Springer:*
 — Alden.
 — Duchess No. 2 and No. 3.
 — Hebbel White.
 — Jenney.
 — Lewis Blush.
 — Mary.
 — Manning's Blush
 — Manning's Red.
 — Morris.
 — Matthews Russet.
 — President Smith.
 — Carbough. *Lovett.*
 — Gladstone. *IV & T. Smith. 1889?*
 — Seedless (Bloomless). *Robinette, Munson, McNath Bros*
 — Sweet Dixon. *Munson.*
 Apricot, Santa Fé. *Taber.*
 Areca Aliceæ. A palm from Java. *Reasoner.*
 Asparagus, sp. from South Africa. *Reasoner.*
 Aster, Royal Mixed. *Faxon.*
 Attalea guichire. Extremely long-leaved palm. S. Amer. *Reasoner.*
 Aucuba cranifolia. *Berckmans.*
 Azalea Kagoshima. *Berger.*
 Bactris flavispina. *Reasoner.*
 Balsam, Alabaster. *Hallock.*
 — Preferred. *Childs.*
 — Perfection Pink. *Burpee.*
 — Splendens. *Burpee.*
 — Sunshine. *Burpee.*
 Bauhinia Hookeri, from Australia. *Reasoner.*
 Bean, Burpee's Bush Lima. *Burpee.*
 — Bush Lima. *Henderson.*
 — Currie's Rust-proof Golden Wax. *Currie Bros.*
 — Cylinder Black Wax. *Henderson.*
 — Cylinder Ivory Pod Wax. *Hallock.*
 — Ford's Mammoth-podded Lima. *Johnson & Stokes.*
 — Hallock's Tree Bean. *Hallock.*
 — Kumerle's Dwarf Lima. *Thorburn.*
 — Pink Eye Wax. *Landreth.*
 — Yosemite Mammoth Wax. *Henderson.*
 Beet, Early Crimson. *Faust.*
 — Mitchell's Dark Red Turnip. *Johnson & Stokes*

- Begonia bicolor. Mexico. *Horsford*.
 — Lubbersii. South America. *Saul*.
 Berberis nervosa. *U. S. Nur.*
 Blackberry, Thompson's Early Mammoth. *Cleveland Nurs. Co*
 Bouvardia, Etna. (Garden hybrid.) *Saul*.
 — flavescens. (Garden hybrid.) *Saul*.
 — lutea flore-pleno. (Garden hybrid.) *Saul*.
 — White Bouquet. *Henderson*.
 Boweia volubilis. A leafless liliaceous plant Natal. *Reasoner*.
 Brunsvigia, sp. Zululand. *Reasoner*.
 Cabbage, Autumn King. *Henderson*.
 — Gregory's Hard-heading. *Gregory*.
 — Hard-heading Red. *Burpee*.
 — Market Gardener's No. 2. *Johnson & Stokes*.
 — Southern Cross. *Hallock*.
 — Strang. *Hallock*.
 Calamus, three species. Indian Rattan palms. *Reasoner*.
 Calliopsis, New Double. *Childs*.
 Calliphuria Hartnegiana. *Reasoner*.
 Caryota Blancoi. A variety of the "Toddy palm." *Reasoner*
 Cauliflower, Early Alabaster. *Johnson & Stokes*.
 — Early Padilla. *Tillinghast*.
 — Early Puritan *Ferry*.
 Cattleya Eldorado alba. South America. *Saul*.
 — Percivalliana alba. South America. *U. S. Nur.*
 — Trianæ Smithiæ. South America. *U. S. Nur.*
 Celery, Kalamazoo Broad-ribbed. *Johnson & Stokes*.
 Chicory, Asparagus. *Childs*.
 Chrysanthemum, Adirondac. *U. S. Nurseries*.
 — Ada Spaulding. *Spaulding*.
 — Alaska. *U. S. Nur.*
 — Brunhild. *U. S. Nur. 1890*.
 — Charity. *Hallock*.
 — Cortez. *U. S. Nur. 1890*.
 — Cyclone.
 — E. G. Hill.
 — Elsie.
 — George Pratt. *Henderson*.
 — Grove P. Rawson.
 — Henry Elkins Widener.
 — Huron. *U. S. Nur. 1890*.
 — Kioto.
 — Leopard. *Henderson*.
 — Lillian B. Bird.
 — Louis Boehmier. Imported.
 — Malabar. *U. S. Nur.*
 — Manitou. *U. S. Nur.*
 — Miss M. A. Haggis.
 — Monadnoc. *U. S. Nur.*
 — Montauk. *U. S. Nur. 1890*.
 — Montezuma. *U. S. Nur.*

- Chrysanthemum, Moonstone. *U. S. Nur.* 1890.
 — Mountain of Snow.
 — Mrs. Alpheus Hardy. *U. S. Nur.* Sparingly distributed in 1888.
 — Mrs. Andrew Carnegie. *Thorpe.*
 — Mrs. De Witt Smith. *U. S. Nur.*
 — Mrs. Fottler.
 — Mrs. S. Coleman.
 — Mrs. Thomas A. Edison.
 — Narragansett. *U. S. Nur.*
 — Nymphæa. *H. W. Hales.*
 — Omar. Imported.
 — Oriole.
 — Osceola. *U. S. Nur.* 1890.
 — Peculiarity
 — Ramona. *U. S. Nur.*
 — Rose Hill.
 — Rose Queen. *Hallock.*
 — Rosebank Gem.
 — Sachem. *U. S. Nur.*
 — Semiramis. *U. S. Nur.* 1890.
 — Shasta. *U. S. Nur.* 1890.
 — Tacoma. *U. S. Nur.* 1890.
 — Tecumseh. *U. S. Nur.* 1890.
 — V. H. Hallock. *Hallock.*
 — Violet Tomlin.
 — White Cap. *Hallock.*
 Cissampelos heterophylla. A Japanese climber. *Reasoner.*
 Clerodendron delectum. East Indies. *Saul.*
 Coconut (*Cocos nucifera*). The following varieties, by *Division of Pomology, Department of Agriculture*, from Philippine Islands.
 — Bahan.
 — Baraves.
 — Bosa.
 — caputiformis.
 — Cayomanis.
 — Dajili.
 — grandis.
 — Maputi.
 — Pequenitos.
 — Polac.
 — rubescens.
 Cocos Dattel. *Reasoner.*
 Coleus, Black Dwarf. *Henderson.*
 Colocasia enchlora. *Reasoner.*
 — odora. *Reasoner.*
 Colvillea racemosa. From Mauritius. *Reasoner.*
 Cordyline superbiens. *Reasoner.*
 Corn, Burlington Hybrid. *Johnson & Stokes.*
 — Durkee. *Gregory.*
 — Early Conqueror. *Faust.*
 — Giddings. *Giddings & Read.*

- Corn, Gold Coin. *Livingston.*
 — Maule's XX Sugar. *Maule.*
 Corypha umbraculifera. The famous "Talipot Palm." *Reasoner*
 Crinum crassifolium. *Reasoner.*
 Cryptostegia grandiflora. From India. The juice, exposed to sunshine,
 produces pure caoutchouc. *Reasoner.*
 Crytolepis Buchanani An Indian twining shrub. *Reasoner.*
 Cucumber, White Pearl. *Burpee.*
 Cycas Bellefontii. *Reasoner.*
 — comoriensis. *Reasoner.*
 Cyrtopodium. The following have been introduced by the *United States'*
Nurseries :
 — albo-purpureum superbum. Hybrid.
 — Argus platypetalum. India.
 — bellatulum superbum. India.
 — Boxallii aureum. India.
 — — atratum magnificum. India
 — — grande. India.
 — calurum Rougierii. Hybrid.
 — Carnusianum. Hybrid.
 — Californicum. United States.
 — Chelsiense. Hybrid.
 — conspicuum. Hybrid.
 — — pictum. Hybrid.
 — Godefroyæ Smithæ. India.
 — Haynaldianum superbum. India.
 — Harrisianum luteolum. Hybrid.
 — insigne corrugata. Assam.
 — — Caulsonianum. Assam.
 — — Wallacei. Assam.
 — intermedium. Hybrid.
 — lævigatum Cannærtianum. India.
 — Lawrenceanum Hycanum. Borneo.
 — — auriculum. Borneo.
 — Lemonierii. Hybrid.
 — Mackenii. *Reasoner.*
 — magniflorum. South America.
 — marmorophyllum superbum. Borneo.
 — Marshallianum. Borneo.
 — Masereelianum. Hybrid.
 — Pageanum. Borneo.
 — Pitcherianum. Hybrid.
 — Pleistochlorum. Hybrid.
 — purpuratum Kimballianum. China.
 — Savageanum. Hybrid.
 — Schlimii giganteum. South America.
 — Schomburgkianum. South America.
 — Stonei candidum. Borneo.
 — tonsum cupreum. Sumatra.
 — Wallisii superbum. South America.
 Cyrtanthus sanguineus. *Reasoner.*

- Dæmonorops, in five species. Thorny East Indian palms. *Reasoner*.
- Dahlia. 100 single varieties. *U. S. Nur.*
- Dandelion, Hallock's Mammoth. *Hallock*.
- Datura, Sweet Nightingale. *Childs*.
- Dendrocalamus strictus. One of the tallest growing and most important bamboos; from India. *Reasoner*.
- Dendrophylax funalis. Leafless orchid; Jamaica. *Reasoner*.
- Diplothemium candescens. A Brazilian stemless palm. *Reasoner*.
- Dodonea divia. "Switch Sorrel." From Australia. *Reasoner*.
- remotiflora. *Reasoner*.
- Dyckia sulphurea. *Reasoner*.
- Eichhornia (Pontederia) azurea. *E. D. Sturtevant*.
- Escallonia Phillipiana. *Berckmans*.
- Euonymus Hamiltonianus. *U. S. Nur.*
- Eritrichium barbigrum. *Bridgeman*.
- Euphorbia heterophylla. *Goodell*.
- Exochorda Alberti. *Berckmans*.
- Gaillardia, Gypsy Queen. *Dingee & Conard*.
- Gladiolus, Snow White. *All dealers. Originated with J. F. C. Hyde*.
- Glechoma hederacea, var. *Henderson*.
- Gmelina parviflora. Hard-wooded Indian tree. *Reasoner*.
- Goodyera Schlechtendæ. *U. S. Nur.*
- Gooseberry, Golden Prolific. *John Charlton, Rochester*.
- Gordonia anomala. A species of "Loblolly Bay." India. *Reasoner*.
- Grape, Brilliant. *Munson*.
- Esther. *Josselyn*.
- Geneva. *Chase*.
- Green Mountain. *Hoyt's Sons*.
- Jæger. *Munson*.
- Rockwood. *Josselyn*.
- Rommel. *Munson*.
- Thompson's Seedless. *Wm. Thompson, Sr., and John P. Onstott, Yuba City, Cal.*
- White's Northern Muscadine. *Culinary Grape Co.*
- The following native species of grapes have been introduced by *Munson* :
- Vitis Arizonica, Engelm.
- æstivalis, Michx. Possesses valuable wine properties.
- Berlandieri, Planchon. The species now so much sought after by the French as a graft-stock, and to hybridize upon.
- bicolor, LeConte. The Michigan and Wisconsin form of *V. æstivalis*.
- Bourquina, Munson. Species to which Herbemont, etc., belong.
- Californica, Bentham. Too tender for open ground.
- candicans, Engelm. Mustang grape of Texas.
- cinerea, Engelm. Also nearly equivalent to *V. Berlandieri* for same purpose.
- cordifolia, Michx.
- coriacea, Shuttleworth. Florida grape; scarce; very striking.
- Doaniana, Munson. Excellent for hybridizing.
- Labrusca, Linnæus. To which Concord, Perkins, etc., belong.
- Linsecumii, Texas Post-Oak Grape. Valuable to hybridize.
- monticola, Buckley. Rare and fine for the experimenter.

- Grape, *Vitis Munsoniana*, Simpson. South Florida, everbearing
 — *riparia*, Michaux. Excellent for hybridizing.
 — *rubra*, Michx. Very handsome, ornamental.
 — *rupestris*, Sheele. Excellent to hybridize with others.
 — *Simpsonii*, Munson. Native of Florida
 — *Solonis*, Engelm. Excellent for hybridizing.
 — *vulpina*, Linnæus. Muscadines, Southern States.
 V. *Arizonica*, *Californica*, *Candicans*, *Linsecomii*, *monticola*, *Solonis*,
 have been long in cultivation by *Berckmans*.
Hæmanthus Katherinæ. *Reasoner*.
Heliotrope, Dark Bouquet. *Burpee*.
Heterospathe elata. *Reasoner*.
Hevea Braziliensis. Producing "para rubber." *Reasoner*.
Hydrangea aspera. *Berckmans*.
 — *stellata rubra plena*. *Henderson*.
 — *Pekinensis*. China. *Saul*.
Ismene Macleayana. *Reasoner*.
Iris Caroliniana, n. sp. *U. S. Nur.* Discovered in North Carolina by W.
 A. Manda.
Lælia autumnalis alba. Mexico. *U. S. Nur.*
 — *Arnoldiana*, n. sp. Mexico. *U. S. Nur.*
 — — *Forstermanii*. Mexico. *U. S. Nur.*
 — *purpurata pretexta*. Brazil. *U. S. Nur.*
 Lettuce, California All-Heart. *Johnson & Stokes*
 — Gold Nugget. *Burpee*.
 — New Queen. *Faust*.
 — White Russian Summer. *Johnson & Stokes*.
Lilium Carniolicum. *U. S. Nur.*
Livistona altissima. Palmate-leaved palm from Timor. *Reasoner*.
 — *olivaeformis*. *Reasoner*.
 — *subglobosa*. Resembling the so-called *Latania Borbonica* (*L. chinensis*).
Reasoner.
Maakia Amurense. *Berckmans*.
Magnolia Soulangeana nigra. *Berckmans*.
 Mango, Alphonse. *Div. Pomology, Dept. Agr.*
 — Banchoire. *Div. Pomology, Dept. Agr.*
 — Banchoire of Dhirie. *Div. Pomology, Dept. Agr.*
 — Devarubria. *Div. Pomology, Dept. Agr.*
 — Mulgoba. *Div. Pomology, Dept. Agr.*
 — Pirie. *Div. Pomology, Dept. Agr.*
 Mangoes, Bombay, from North West India. *Reasoner*.
 Marigold, Dahlia-flowered. *Childs*.
Marsdenia Royleii. A fiber and dye plant from the East Indies. *Reasoner*.
Morœa, sp. Zululand. *Reasoner*.
Morus alba. Variety from the Himalayas. *Reasoner*.
 Mulberry, Lampas, or Everbearing. *Munson*.
Musa textilis. The "Manilla" banana, producing "Manilla hemp" of
 commerce. *Div. Pomology, Dept. of Agriculture*.
 Muskmelon, Colorado Giant. *Johnson & Stokes*.
 — Delmonico. *Henderson*.
 — Irondequoit. *Vick*.

- Muskmelon, Persian Monarch. *Johnson & Stokes*.
 — Salmon and Green. *Landreth*.
 Myrica rubra. *Berger*.
 Nuttalia cerasiformis. *Berckmans*.
 — splendidum. Guatemala. *Saul*.
 Oncidium triquetrum violaceum. From Jamaica. *Reasoner*.
 Onion, Madrid Giant. *Johnson & Stokes*.
 — Michigan Yellow Globe. *Ferry*.
 — Red and White Victoria. *Burpee*.
 Opuntia vestita. *Reasoner*.
 Othera Japonica. *Berckmans*.
 Pea, Sutton's Satisfaction. *Johnson & Stokes*.
 Peach, Angel. *Taber*.
 — Dwarf Japan Blood. *Champlin*.
 — Imperial. *Taber*.
 — Laura. *Taber*.
 — Red Ceylon. *Reasoner*.
 Pear, Idaho. *Idaho Pear Co*. This fruit has been before the public for two or three years, but it is first formally introduced the present year.
 Pecan, Riverside. *Munson*.
 Pepper, Coral Gem Bouquet. *Beyer*.
 Persimmon, Early Golden. *Champlin*.
 Philodendron Andreanum. Central America. *Saul*.
 Phlogacanthus thyrsoiflorus. From Northern India. *Reasoner*.
 — Drummondii, Child's Jubilee. *Childs*.
 Phlox, Pearl. *U. S. Nur*.
 Plum, Abundance. *Lovett*.
 — Burbank No. 2. *Luther Burbank*, Santa Rosa, Cal
 — Hawkeye. *Terry*.
 — Saratoga. *Green*.
 — Satsuma Blood. *Burbank*.
 — Shaw. *Lovett*.
 Pomelo, Aurantium. *Mott*.
 Poppy, Fairy Blush. *Burpee*.
 — Red Bird. *Dingee & Conard*.
 Potato, Alligator. *Rawson*.
 — Ben. Harrison. *Giddings & Read*.
 — Bliss' Rough Diamond. *Hallock*.
 — Burpee's Extra Early, or Seedling No. 37. *Burpee*.
 — Early Market. *Vick*.
 — Fillbasket. *Eastman*.
 — Gov. Foraker. *Stine*.
 — Iowa Beauty. *Iowa Seed Co*.
 — London. *Pearce*.
 — Minister. *Ferard*.
 — Mrs. Foraker. *Stine*.
 — Murray's Gold-Flake. *Stine*.
 — New Eyeless Seedling. *Vaughan*.
 — Pride of St. Paul. *Fisher and Fisher*.
 — Pride of the Market. *Tillinghast*.
 — Pride of the Table. *Tillinghast*.

- Potato, Pride of the Field. *Tillinghast.*
 — Pride of Wisconsin. *Currie Bros.*
 — Red Snowflake. *Harrington.*
 — Roger's Seedling. *Giddings & Reed.*
 — Rural New-Yorker No. 2. *Thorburn.*
 — Seneca Beauty. *Livingston.*
 — Superior. *Burpee.*
 — 1889. *Faust.*
 Pourthiœ villosa. *Berckmans.*
 Prunus Plantierii, fl. pl. *Berckmans.*
 — serotina pendula. *Berckmans.*
 — subcordata. *Munson.*
 Pumpkin, Golden Oblong. *Burpee.*
 — Jonathan. *Henderson.*
 Radish, Red Rocket. *Henderson.*
 — Startle. *Johnson & Stokes.*
 Raspberry, Ada. *T. F. Longnecker, Dayton, O.*
 — Muskingum. *F. R. Palmer.*
 — Palmer. *F. R. Palmer, Mansfield, O. Fall of 1888.*
 — Progress. *Lovett.*
 Reinwardtia tetragyna. *Himalayas. Saul.*
 Ricinus Cambogiensis. *Henderson.*
 Rose, Comtesse Anna Thun. *Several firms.*
 — Duchess of Albany. *Several firms.*
 — Duchesse d' Auerstadt. *Several firms.*
 — Edward Pailleron. *Several firms.*
 — Elie Beauvilian. *Several firms.*
 — Gloire de Libourne. *Dingee & Conara.*
 — Gloire d' Olivet. *Berckmans.*
 — Mad. Agathe Roux. *Several firms.*
 — Mad. Ernest Piard. *Several firms.*
 — Mad. Claire Jaubert. *Several firms.*
 — Queen. *Dingee & Conard.*
 — Rainbow. *John H. Sievers, San Francisco*
 — Souv. de Mad. Metral. *Several firms.*
 — Therese Lambert. *Several firms.*
 — Vick's Caprice. *Vick.*
 Rubus, mixed raspberry plants from South Slopes, Himalaya mountains.
Reasoner.
 Schubertia grandiflora. *South America. Saul.*
 Scilla Veransii, from Cape of Good Hope. *Reasoner*
 Senecio Japonicus. *U. S. Nur.*
 — Kæmpferi. *U. S. Nur.*
 Sphæralcea umbellata. *Saul.*
 Squash, Golden Custard. *Henderson.*
 — Woodbury. *Giddings & Reed.*
 Strawberry, Crawford. *Storrs & Harrison Co.*
 — Durand's Nectar. *Henderson.*
 — Eureka. *Cleveland Nursery Co.*
 — First Season. *Chilas.*
 — Great Pacific. *D. J. Piper, Forreston, Ill.*

- Strawberry, Michel's Early. *Bauer*.
 — Miami. *J. D. Kruschke. Piqua, O.*
 — Osceola. *Osceola Park Nursery Co., Mo.*
 — Parker Earle. *Munson*.
 — Shuster's Gem. *Lovett*.
 — Tilton. *S. C. DeCou, Moorestown, N. J.*
 — Viola. *S. R. Kramer. Gahanna, O.*
 — Walton. *Horner*.
 — Yale. *Hoyt's Sons*.
Stephanandra flexuosa. Berckmans.
Strobilanthus callosus. Reasoner
Styrax Obessia. U S Nur.
 Sweet Pea, improved Hybrids. *Eckford*.
 — Miss Blanche Ferry *Ferry*.
 Syringa, Improved Hybrids *Eckford*.
 — LeGaulois (double) *Berckmans*.
 — Souvenir de Spath (double). *Berckmans*.
 Tecoma Mackenii. South Africa. *Sau.*
 Tigridia buccitera. Mexico. *Horsford*.
 — Pringlei. Mexico. *Horsford*.
 Tomato, Annie Dine. *Samuel Wilson*.
 — Atlantic Prize. *Johnson & Stokes*.
 — Brandywine. *Johnson & Stokes*.
 — Golden Jubilee. *Childs*
 — Ignotum. Originated at the *Michigan Agricultural College* in 1887 and distributed somewhat during 1888 and 1889. First appears in seedmen's catalogues in 1890.
 — Lorillard. *Cowan*.
 — McCullom's Hybrid. *Vick*.
 — Prelude. *Horsford*.
 — Shah. *Henderson*.
 Trithrinax Brasiliensis. Rapid growing palm. *Reasoner*.
 — ? A new fan-leaved palm from Peru. *Reasoner*.
 Turnip, Bread-stone. *Burpee*.
 Viola cucullata, alba. *U. S. Nur.*
 Water-melon, Arkansas Traveller. *Landreth*.
 — Delaware. *Burpee*.
 — Hallock's Phinney. *Hallock*.
 — Liberian. *Johnson & Stokes*.
 — White Gem. *Burpee*.
 Xanthorhea hastilis. The "Grass Tree of Australia. *Reasoner*.
 — minor. A sub-species of above. *Reasoner*.
 Xylosma longifolia. *Reasoner*.
 Zingiber corallinum. Ceylon. *Reasoner*.
 Zinnia, Tom Thumb. *Vick*.

2. *Catalogue of American Kitchen Garden Vegetables.*

A LIST OF THE VEGETABLES, EXCLUSIVE OF MEDICINAL HERBS, OFFERED FOR SALE IN NORTH AMERICA IN 1889, WITH REVISION OF THE NAMES BY THE COMMITTEE ON NOMENCLATURE OF VEGETABLES APPOINTED BY THE ASSOCIATION OF AMERICAN AGRICULTURAL COLLEGES AND EXPERIMENT STATIONS.

Statement of the Committee on Nomenclature.—The committee, in revising the names of American vegetables, has labored upon the principle that “a name is bestowed upon any plant solely for the purpose of designating it.” In other words, it has endeavored to make every name as short and simple as possible, and yet avoid confusion. It has been thought best in this list to keep separate all names which have been independently applied to varieties, and, therefore, no attempt has been made to determine synonyms. The five rules governing the form of the name, adopted by this committee, have formed the basis of all changes. These rules are: 1. The name of a variety should consist of a single word, or at most of two words. A phrase, descriptive or otherwise, is never allowable. 2. The name should not be superlative or bombastic. 3. If a grower or dealer has procured a new select strain of a well-known variety, it shall be legitimate for him to use his own name in connection with the established name of the variety. 4. When personal names are given to varieties, titles should be omitted. 5. The term hybrid should not be used, except in those rare instances in which the variety is known to be of hybrid origin.

It is impossible to make all published names of vegetables conform to the above rules. The rules are of necessity ideal; they are particularly designed to control the making of new names rather than for the reformation of old ones. The committee has made all changes thoughtfully, and yet it is aware that its work may be often open to objection. In such cases it desires the aid of any honest criticism. In the application of the code, many minor rules have been drawn, but there are many instances in which no rule or precedent could apply, and purely arbitrary decisions were necessary. The following minor rules will explain the attitude of the committee: 1. In all the revisions the committee has simply modified the existing names; no new words have been introduced. 2. So far as practicable, it has selected for the proper name the one

most important word in each customary appellation. 3. There has been no attempt in the names to give credit or honor to any person; the purpose of the name is to designate the plant, and all other considerations are extraneous. If the originator or introducer desires to associate his name with his product, the proper way is to give the plant simply his name, omitting the burden of adjectives. 4. In proper names the possessive case has been omitted, and the name, if allowed to remain, stands in apposition, or as an adjective. The only departure from this rule is in the case of new strains of old varieties (see Rule 3 in Code). Thus, in peas, Laxton's Prolific becomes Laxton Prolific. Here the personal name would have been dropped altogether only that the term *prolific* is so much used and abused that it means nothing by itself; and to have used the personal name alone would have added confusion, because there are several other Laxton peas. 5. The word *seedling*, which is meaningless in this connection, is always dropped, and the personal name attached to it becomes the name of the variety. 6. In a few old varieties which are now little grown it has not seemed worth while to attempt to revise the name. An example may be found in President Garfield tomato, which, it is to be hoped, will be forgotten before any new name could have been learned. 7. All descriptive adjectives have been omitted whenever the change would not be likely to lead to confusion. In some cases, however, three of these adjectives must be retained in order to distinguish the variety; as, Dwarf Round Purple and Large Round Purple egg-plants. *Dwarf* and *Large* are necessary to distinguish the varieties from each other, *Round* is necessary to distinguish both from the Long Purple, and *Purple* distinguishes them from the Long White. 8. In phrases which could not be shortened to a word the connective is usually dropped, or in rare cases the phrase is transposed: First in the Market has been made First Market, and Champion of America becomes American Champion.

The committee is aware that its labor is largely self-imposed, and that it is in no manner dictatory; but if it shall succeed in inspiring "brevity, accuracy, and good taste in the naming of vegetables" in the future, it will have done enough.

L. H. BAILEY,
E. S. GOFF,
W. J. GREEN.

ANISE—*Pimpinella Anisum*.

ARTICHOKE—

- Campania (New Early Violet Campania).
 - French Globe (French Green Globe).
 - Giant Globe (Giant Green Globe).
 - Large Globe.
 - Naples (Large Green Naples).
 - Paris (Largest Paris).
 - White French (Mammoth White French).
- 7 varieties.*

ASPARAGUS—

- Colossal.
 - Cross-bred (Moore's Cross-bred).
 - Eclipse.
 - Giant (Moore's Giant).
 - Hub.
 - Mammoth.
 - Palmetto.
 - Philadelphia (Philadelphia Mammoth).
 - Purple-top (Large Purple-top).
- 9 varieties.*

BALM—*Melissa officinalis*.

BASIL—*Ocimum Basilicum*.

BEAN—

- Algiers Black (Algiers Black Wax Dwarf).
- Algiers White (White Algerian.)
- Andalusian (Andalusian Wax).
- Aroostook (Early Aroostook).
- Atlantic (Jones' Atlantic).
- Best Dwarf (Best of all Dwarf).
- Bismarck.
- Black-eyed Wax.
- Black Wax.
- Blue-podded Butter.
- Boss
- Boston Pea (Boston Small Pea).
- Boston Wax.
- Broad Wax.
- Brockton.
- Burlingame (Burlingame's Medium).
- California Branch.
- California Pole (Bound's California Pole).
- Canadian (Canadian Wonder.)

Carolina, or Sieva (Dwarf Carolina).

Champion (Low's Champion).

China (Early China, Early China Dwarf).

China Red-eye.

Cluster (Dreer's Early Cluster).

Concord.

Crimson Flageolet.

Crystal Wax (Crystal White Wax).

Cylinder Black Wax.

Cylinder Ivory-pod (Cylinder Ivory-pod Wax).

Date Wax (Date Wax Dwarf).

Detroit Wax

Dun-colored (Early Dun-colored).

Dutch Case-knife.

Dutch Runner (Improved Dutch Runner)

Dwarf Bonnemain.

Dwarf Horticultural.

Dwarf Mont d'Or.

Dwarf Prolific.

Dwarf White Wax.

Early Six-weeks (Early Yellow Six-weeks).

Emile (French Emile).

Erfurt (Ruby of Erfurt).

Etampes, or Canterbury (French Etampes, English Canterbury).

Everbearing Wax.

Excelsior Wax.

Feejee (Early Feejee).

First Market (Landreth's First in the Market).

Flageolet Wax (Flageolet Dwarf Wax).

French Asparagus.

Fulmer (Fulmer's Early).

Galega, or Large Refugee.

German Wax (Dwarf German Black Wax).

German Wax Pole.

Giant Wax.

Goddard, or Boston (Goddard's Horticultural Boston Favorite).

Golden Butter (Dwarf Golden Butter).

Golden Cluster (Golden Cluster Wax Pole).

Golden Refugee.

BEAN, *continued.*

Golden Flageolet (New Golden Wax Flageolet).
 Golden-eyed Wax (Early Golden-eyed Wax).
 Golden Wax (Dwarf Golden Wax).
 Green Flageolet, or Frame (Flageolet Improved Green, or Wonderful Frame).
 Green Nonpareil.
 Hallock's Tree.
 Horticultural, or Cranberry (Speckled Cranberry).
 Indian Chief, or Algerian Wax.
 Ivory-pod Wax Kentucky (Kentucky Wonder).
 Kentucky (Kentucky Wonder).
 Kidney Wax (New Kidney Wax).
 King Green (King of the Greens).
 Lady (Painted Lady).
 Landreth Scarlet (Landreth's Scarlet).
 Landreth Violet (Landreth's Violet).
 Lazy Wife (Lazy Wife's Pole).
 Lemon-pod Wax (Lemon-pod Late Wax).
 Long Six-weeks (Long Yellow Six-weeks).
 Maine, or Essex (Early Maine Essex Prolific).
 Marblehead Champion.
 Marblehead Horticultural.
 Maule's Butter Wax.
 Mohawk (Early Mohawk).
 Mont d'Or.
 Navy (White Navy).
 Newington (Newington Wonder).
 Newtown (Thorburn's Pride of Newtown).
 Ne Plus Ultra.
 Perfection Wax.
 Pink-eye Wax.
 Portland (Portland Fancy).
 Powell (Powell's Prolific Pole).
 Prolific Tree.
 Procton Horticultural (New Procton Horticultural).
 Rachel.
 Red Cranberry.
 Red French.

Red Kidney.
 Red Valentine (Early Red Valentine).
 Refugee (Thousand to One).
 Rhode Island Case-knife (Rhode Island Dwarf Case-knife).
 Rhode Island Creaseback.
 Rhode Island Red-pod.
 Round Six-weeks.
 Round-pod Valentine.
 Royal (Royal Dwarf White Kidney).
 Rust-proof (Currie's Rust-proof Golden Wax).
 Scarlet Flageolet (Dwarf Scarlet Flageolet).
 Scarlet Runner—*Phaseolus multiflorus*.
 Scimeter (White Scimeter).
 Sion House.
 Snow-flake (Gregory's Snowflake).
 Southern Prolific.
 Soup (White Soup).
 Speckled Cut-short (Red Speckled Cut-short Pole).
 Stanton Early.
 Stanton Extra (Stanton's Extra Early Bush).
 Tasmania (Mammoth Tasmania).
 Transylvania (Trans. Butter Pole).
 Tree (Early Tree).
 Valentine (Cleveland's Valentine).
 Violet Flageolet.
 Volga (Volga Kidney).
 Wardwell (Wardwell's Dwarf Kidney Wax).
 Warren (Warren Bush).
 Wilson Bush (Wilson's Best of All Bush).
 White Creaseback (White Creaseback Pole).
 White Cut-short (White Cut-short Pole).
 White Kidney (Large White Kidney).
 White Marrowfat.
 White Pea.
 White Runner (Improved White Runner).
 White-seeded Wax

BEAN, *continued.*

White-seeded Runner (New White-seeded Runner).
 White Valentine.
 White Wax.
 William (Emperor William).
 Woodward (Woodward Pole).
 Yard Long, or Cuban Asparagus
 Yellow Cranberry
 Yellow-eye.
 Yosemite (Yosemite Mam. Wax).
 Zulu (White Zulu)

141 varieties.

BEAN, ENGLISH—*Vicia Faba.*

Broad Windsor.
 Mazagan (Early Mazagan).
 Nonpareil (Nonpareil Long-pod).
 Sword Long-pod.

4 varieties.

BEAN, LIMA AND SO-CALLED LIMAS—

Burpee's Bush.
 Challenger.
 Dreer (Dreer's Improved.)
 Extra Early.
 Henderson's Bush (Henderson's New Bush Lima).
 Jersey (Jersey Extra Early).
 Kumerle (Kumerle's Dwarf).
 King (King of the Garden).
 Large White.
 Mammoth-podded (Ford's Mammoth-podded).
 Potato.
 Speckled (Speckled Early).
 Vermont.

13 varieties.

BEET—

Arlington (Arlington Favorite)
 Bastian's Blood Turnip.
 Bastian Early (Bastian's Early).
 Bastian Half-long (Bastian's Half-long Blood Red).
 Bassano (Early Flat Bassano).
 Blood Turnip (Early and Improved Blood Turnip).
 Brazilian Variegated.
 Crimson-veined Brazilian.
 Crosby's Egyptian.
 Dell.
 Dewing's Blood Turnip (Dewing's Improved Blood Turnip)

Dracæna-leaved.

Early Blood
 Early Crimson.
 Early Turnip.
 Eclipse.
 Edmand's Blood Turnip.
 Egyptian (Egyptian Turnip)
 Fifty Day.
 Golden-veined Brazilian.
 Grange (Grange Autumn White Cap).
 Half-long Dark, or Pear-Shaped.
 Imperial (Knauer's Improved Imperial).
 Jewel (New Early Jewel).
 Long Blood (Improved Long Blood Red).
 Landreth Early (Landreth's Very Early).
 Mitchell's Turnip (Mitchell's Dark Red Turnip).
 Ne Plus Ultra.
 Pineapple.
 Scarlet-ribbed Chilian.
 Scarlet-veined Brazilian.
 Silesian Sugar.
 Silver-ribbed (Large Ribbed Silver).
 Smooth Blood (Long Smooth Blood Red).
 Strasburg (Pyriform Strasburg).
 Swiss Chard, Silver, or Sea-Kale Beet.
 Turin (Extra Early Flat Turin).
 Victoria.
 Victoria Chard (Victoria Blood Red Swiss Chard).
 White.
 Yellow-ribbed Chilian.
 Yellow Turnip (Early Yellow Turnip).

42 varieties.

BEET, MANGEL WURZEL and SUGAR BEETS—

Alexander Sugar (Alexander's New White Sugar).
 Burpee Garnishing (Burpee's Garnishing).
 Cattle Post (Maule's Cattle Post).
 Champion Yellow, or Orange Globe.

BEET, (MANGEL or SUGAR), *continued.*

Dwarf Curled.
 Imperial (Breck's Imperial Sugar).
 Intermediate (Giant Intermediate).
 Jersey (Everitt's Jersey Queen).
 Jumbo.
 Kinver Globe (Kinver Yellow Globe).
 Lane (Lane's Sugar).
 Long Red.
 Long Yellow.
 Mammoth Long (Mammoth Long Red).
 Negro (Long Negro).
 Norbiton (Norbiton Giant).
 Oberndorf (Large Yellow Oberndorf).
 Orange County (Orange County Colossal Long Yellow).
 Orange Globe.
 Prize Long (Mammoth Prize Long Red).
 Red-topped (Red-topped Sugar).
 Red Globe.
 Red Tankard (New Red-fleshed Tankard).
 Silesian.
 Vilmorin (Vilmorin's Improved White Sugar).
 Warden Orange (Warden Orange Globe).
 Warden Yellow (Warden's Prize Yellow Globe).
 White French.
 White Sugar.
 Yellow Ovoid.
 Yellow Mammoth.

31 varieties.

BORAGE—*Borago officinalis.*

BRUSSELS SPROUTS—

Dalmeny (Dalmeny Park).
 Dwarf (Dwarf Improved).
 Perfection.
 Roseberry (Best French).
 Scrymgeour (Scrymgeour's Giant).
 Sutton (Sutton's Matchless).
 Tall French.

7 varieties.

BURNET—*Poterium Sanguisorba.*

CABBAGE—

Advance (Extra Early Advance).
 All Head (Maule's All Head).
 All Seasons.
 American Savoy (American Improved Savoy).
 Autumn King.
 Bacalan (Early Bacalan).
 Bergen (Bergen Head).
 Berkshire (Berkshire Beauty).
 Bleichfield (Early Bleichfield).
 Blood-red Erfurt (Early Blood-red Erfurt).
 Bloomsdale (Bloomsdale Early Market).
 Bristol (P. & K. Large Bristol).
 Bridgeport (Bridgeport Late, Bridgeport Drumhead).
 Bucks County Flat Dutch.
 Bulgarian (Bulgarian Mammoth).
 Canajoharie (Early Canajoharie).
 Cannon Ball (Early Cannon Ball).
 Caste.
 Cox (Cox Early Spring).
 Champion.
 Chase (Chase Excelsior).
 Chinese (Pe-tsai).
 Cone (Early Cone).
 Curled Savoy.
 Danish Ball-head.
 Danish Winter (Danish Round Winter).
 Deep Head (Early Deep Head).
 Denmark (Denmark Drumhead).
 Drumhead Savoy.
 Drumhead Savoy.
 Drumhead Winter (New Drumhead Winter).
 Dutch Drumhead (Early Dutch Drumhead).
 Dwarf Erfurt.
 Dwarf Flat Dutch (Early Dwarf Flat Dutch).
 Dwarf York (Early Dwarf York).
 Early Drumhead.
 Early Erfurt (Extra Early Erfurt).
 Early Flat Dutch.
 Early Wakefield (Early Jersey Wakefield).
 Emperor (Giant Emperor).
 Etampes (Early Etampes).

CABBAGE, *continued.*

Everitt (Everitt's Earliest).
 Everitt Giant (Everitt's Early Giant).
 Everitt's Drumhead (Everitt's Prize Drumhead).
 Everitt's Summer (Everitt's Early Summer).
 Excelsior (Excelsior Flat Dutch).
 Express.
 Faust Crimson (Faust's Early Crimson).
 Faust Earliest (Faust's Ea. of All).
 Filder.
 Filderkraut.
 Fottler Brunswick (Fottler's Improved Brunswick).
 Green Glazed.
 Hard-heading (Gregory's Hard-heading).
 Henderson's Summer (Henderson's Early Summer).
 Hyde Park.
 Landreth Earliest (Landreth's Earliest).
 Late Flat Dutch (American Large Late Flat Dutch).
 Late Drumhead (American Large Late Drumhead).
 Lightning (Salzer's Lightning).
 Little Pixie.
 Louisville Drumhead.
 London (Early London).
 Luxemburg.
 Marblehead (Marblehead Mammoth).
 Market Gardener.
 Market Gardener 2 (Market Gardener's No. 2).
 Midsummer Savoy.
 Mohawk (Early Mohawk Market).
 Montreal (Montreal Market).
 Mountain (Large Late Mountain).
 Netted Savoy.
 Newark (Newark Early Flat Dutch).
 Nonpareil.
 North Carolina (North Carolina Buncombe).
 Oxheart (Early French Oxheart).
 Paris Market (Paris Early Market).

Paris Savoy (Early Paris Savoy).
 Peerless (Low's Early Peerless).
 Perfection Savoy (Perfection Drumhead Savoy).
 Premier.
 Premium Drumhead.
 Premium Flat Dutch.
 Puget Sound.
 Queen (New Queen).
 Red Erfurt (Early Red Dutch Erfurt).
 Red Drumhead.
 Red Dutch.
 Reynolds (Reynolds' Early).
 Rock Red (Mammoth Rock Red).
 Schiltzer.
 Schweinfurt (Large Early Schweinfurt).
 Short-stem (Short-stem Drumhead).
 Silver-leaf (Silver-leaf Drumhead).
 Southern Cross.
 St. Dennis.
 St. John's-day Early (St. John's-day Early Drumhead).
 Stone Mason.
 Strang.
 Succession (Henderson's Succession).
 Sure Head.
 Tourlaville (Early Tourlaville).
 Ulm Savoy (Early Dwarf Ulm Savoy).
 Vandergaw.
 Warren.
 Winnigstadt (Early Winnigstadt).
 Wonderful (Johnson & Stokes' Wonderful).
 Wyman (Early Wyman).
 Year Round (All the Year Round).
 York (Early York).
110 varieties.

CARAWAY—*Carum Carui.*

Common.
 German.

CARDOON—

Puvis.
 Solid (Large Solid, Large Solid Stalked).
 Spanish (Large Spanish).

CARROT—

Altringham (Long Red Altringham).
 Carentan (Early Half-long Scarlet Carentan).
 Chantenay (Chantenay Half-long Scarlet).
 Coreless Scarlet (Coreless Half-long Scarlet).
 Coreless Red (Coreless Long Red).
 Danvers Half-long (Danvers Half-long Orange).
 Early Horn.
 Early Forcing (Extra Early Forcing).
 French Forcing (Early French Forcing).
 Golden Ball (Early Short Scarlet or Golden Ball).
 Half-long Pointed.
 Half-long Red.
 Half-long Scarlet (Early Half-long Scarlet).
 Half-long Stump (Half-long Stump-rooted).
 Intermediate (Red Intermediate).
 Long Orange.
 Long White (Giant Long White).
 Luc Half-long (Early Half-long Luc).
 Luc Stump.
 Mitchell (Mitchell's Perfection).
 Model (Scarlet Model).
 Nantes (Half-long Scarlet Nantes).
 Orange Giant.
 Oxheart (Guerande).
 Scarlet Horn (Early Scarlet Horn).
 Short Horn (Earliest Short Horn).
 St. Valery (New Intermediate).
 Turnip-rooted (Orange Turnip-rooted).
 Vosges (Large White Vosges).
 Vermont Butter.
 White Belgian (Large White Belgian).
 Wiltshire (Giant White Wiltshire).
 Yellow Belgian.

33 varieties.

CAULIFLOWER AND BROCCOLI—

Alabaster (New Early Alabaster).
 Algiers (Large Late Algiers).
 American (American Beauty).
 Asiatic (Large Asiatic).
 Autumn Giant (Italian).
 Berlin (Berlin Dwarf).
 Best Early (Burpee's Best Early).
 Carrara (Carrara Rock).
 Carter (Carter's Summer).
 Chapel (Chapel's Cream).
 Defiance (Carter's Defiance).
 Dwarf Champion (Carter's Dwarf Champion).
 Dwarf Erfurt (Early Dwarf Erfurt).
 Dwarf Mammoth (Carter's Dwarf Mammoth).
 Early Dutch.
 Early London.
 Early Purple.
 Early White.
 Expert (Dwarf Expert).
 Favorite.
 French (Large French).
 Gerry Island.
 Half-dwarf French.
 Ideal (Vick's Ideal).
 Imperial (French Imperial).
 Italian Early (Italian Early Giant).
 Lackawanna.
 Landreth (Landreth's First).
 Large French (Large White French).
 Late Dutch (Large Late Dutch).
 Late London.
 Large Erfurt (Large Early Erfurt).
 Lenormand (Lenormand's Short-stemmed).
 Long Island (Long Island Beauty).
 Mohawk (Mohawk White Cap).
 Ne Plus Ultra.
 Nonpareil (Half-early Paris).
 Padilla (Early Padilla).
 Paris (Extra Early Paris).
 Perfection.
 Prize (Maule's Prize Earliest).
 Puritan (Ferry's Early Puritan).

CAULIFLOWER AND BROCCOLI, *continued.*

Purple Cape.
 Southampton.
 Sulphur-colored.
 Sea Foam (Extra Early Sea Foam).
 Snow Ball (Extra Early Snow Ball).
 Snow Storm (Dreer's Earliest Snow Storm).
 Stadtholder (Large Late Stadtholder).
 Walcheren (Walcheren White; Large Late Walcheren).
 White Cape.
 White Sprouting.
 White Mammoth (Large White Mammoth).

53 varieties.

CELERIC—

Apple (Apple-shaped).
 Erfurt Giant.
 Large Erfurt.
 Prague (Large Smooth Prague).
 Thorburn (Thorburn's Giant).
 Turnip-rooted.

6 varieties.

CELERY—

American (American White Solid).
 Arlington (Early Arlington).
 Boston Market (Boston Market Dwarf).
 Bouquet.
 Covent Garden (Covent Garden Red).
 Crawford (Crawford Half-dwarf White).
 Clark (Major Clark's Pink).
 Dwarf Crimson.
 Dwarf Golden-heart.
 Dwarf White.
 Dwarf Red.
 Dwarf Rose (New Dwarf Rose).
 Endive-leaved (Dwarf Endive-leaved).
 Eureka (Eureka Self-blanching).
 Fern-leaved.
 Golden Self-blanching (Dwarf Golden Self-blanching).
 Giant Golden-heart.
 Golden Dwarf.

Half Dwarf.

Heartwell (Perfection Heartwell).
 Incomparable Crimson.
 Imperial (Imperial Dwarf Large-ribbed).
 Kalamazoo (Kalamazoo Broad-ribbed).
 La Plume (La Plume Chestnut).
 Large Solid (Solid Large White; Giant White Solid).
 Leviathan (Sealey's Leviathan).
 London (London Red).
 Mammoth Red.
 Manchester. (Manchester Crimson).
 Paris (Paris Golden Yellow).
 Pascal (Giant Pascal).
 Silver Spray (New Silver Spray).
 Sandringham (Sandringham Dwarf White).
 Ivory (Solid Ivory).
 White Walnut.
 White Plume.
 Yellow Solid (Golden Yellow Large Solid).

37 varieties.

CHERVIL—

Curled (Curled Double).
 Tuberous (Tuberous-rooted).

CHICORY, OR SUCCORY—

Brussels, or Whitloof (Large-rooted Brussels).
 Common, or Wild.
 Magdeburg (Large-rooted Magdeburg).

CHIVES, OR CIVES—*Allium Schœnoprasmus.*

COLLARDS, OR COLEWORT—

Georgia.
 Marrow (Landreth's Marrow).
 Rosette (True Rosette).
 Southern.
 White-leaved.

CORIANDER—*Coriandrum sativum.*

CORN, POP—

Amber (Early Amber).
 California (California Golden).
 Dwarf Golden.
 Eight-rowed (Early Large Eight-rowed).
 Egyptian.

CORN, POP, *continued.*

Excelsior.
 Golden Rice.
 Mapledale (Mapledale Prolific).
 Monarch (Monarch White Rice).
 Nonpareil.
 Premium (Premium Pearl).
 Queen (Queen's Golden).
 Red Rice.
 Silver Lace.
 Silver Pearl.
 Snowball (Illinois Snowball).
 Striped Rice.
 Tom Thumb (Golden Tom Thumb).
 Variegated.
 White Pearl.
 White Rice.
 Wisconsin (Wisconsin Eight-rowed).
22 varieties.

CORN, SWEET—

Acme (Acme Evergreen).
 Adams (Early Adams, Burlington).
 Albany.
 Amber Cream.
 Asylum.
 Ballard (Ballard's Early).
 Banana.
 Black Mexican.
 Bonanza.
 Boston Market.
 Boynton.
 Burbank (Burbank's Early).
 Burlington (Burlington Hybrid).
 Burvis (Burvis' Mammoth).
 Champion.
 Chicago Market.
 Concord (Moore's Early Concord).
 Conqueror (Early Conqueror).
 Cory (Cory Early).
 Crawford.
 Crosby (Crosby's Early Sugar).
 Dean (Early Dean).
 Durkee.
 Egyptian (Washington Market).
 Eight rowed (Eight-rowed Sugar).
 Eureka (Pearson's Eureka Early).
 Evergreen (Stowell's Evergreen).

Excelsior.
 Farquhar (Farquhar's Early Crop).
 First Best (First and Best).
 Ford (Ford's Early).
 Gem (Little Gem).
 Genesee (Early Genesee).
 Giddings.
 Gold Coin (Livingston's Gold Coin).
 Hawaii (Hawaii Sugar).
 Henderson (Henderson's Sugar).
 Hickox (Hickox Improved).
 Honey (New Honey).
 King (King of the Earlies).
 Landreth (Early Landreth Market).
 Leet (Leet's Early).
 London (London Market).
 Mammoth (Mammoth Sugar).
 Mammoth Late.
 Marblehead Early.
 Marblehead Mammoth.
 Maule (Maule's XX Sugar).
 Minnesota (Dolly Dutton, or Extra Early Dwarf).
 Mitchell (Mitchell's Extra Early).
 Narragansett (Early Narragansett).
 New England (New England Eight-rowed).
 Northern Pedigree.
 Old Colony.
 Orange (Early Orange).
 Orange County (Orange County Cream).
 Pee and Kay.
 Perfection.
 Perry (Perry's Hybrid).
 Pratt (Pratt's Early).
 Pride (Pride of America).
 Quaker (Ne Plus Ultra).
 Queen (New Queen).
 Roslyn (Roslyn Hybrid).
 Ruby (Ruby Queen).
 Russel (Russel's Prolific).
 Shaker (Shaker's Early).
 Smith (Smith's Early).
 Sonyea (Sonyea Intermediate).
 Southern (Early Southern Sweet).
 Squantum (Squantum Sugar).

CORN, SWEET, *continued.*

Stabler (Stabler's Early).
 Tom Thumb (Extra Early Tom
 Thumb).
 Triumph.
 Tuscarora.
 Vermont (Vermont Pedigree).

76 varieties.

CORN SALAD, FETTICUS—

Broad-leaved.
 Green Cabbaging.
 Large-seeded.
 Lettuce-leaved.
 Round-leaved (Large Round-
 leaved).
 Small-seeded.

6 varieties.

CRESS, OR PEPPER GRASS.

American, or Land.
 Australian.
 Broad-leaved.
 Broad-leaved Winter.
 Curled Garden.
 Extra Curled.
 Fine Curled.
 Iron Clad.
 Upland, *Barbarea vulgaris*.

9 varieties.

CRESS, WATER.

Common.
 Erfurt Sweet.

CUCUMBER—

Arlington (Improved Arlington).
 Arnstadt (Giant of Arnstadt).
 Astonisher.
 Bismarck.
 Black Spine (Cuthill's Black
 Spine).
 Blue Gown.
 Boston Market (Early Boston
 Market).
 Boston Pickling.
 Carter Best (Carter's Best of All).
 Champion (Carter's Champion).
 Chester (Early Chester).
 Chicago (Improved Chicago Pick-
 ling).
 China (Long China).
 Choice (Landreth's Choice).
 Cleveland (Cleveland Pickling).
 Cluster (Early Cluster).

Edinburgh (Duke of Edinburgh).
 English Champion (Champion of
 England).
 Evergreen.
 Florida (Florida Emerald).
 Frame (Early Frame).
 Goliath.
 Grant (General Grant).
 Grecian (Long Grecian).
 Green Mountain.
 Green Prolific.
 Indianapolis (Indianapolis Long
 Green).
 Kenyon (Lord Kenyon's Favorite).
 Lancashire (Lancashire Witch).
 Landreth First (Landreth's First).
 London (London Long Green).
 Long Gem (Pearson's Long Gem).
 Long Green.
 Long Prickly, or Jersey Pickle
 (Extra Long Green Prickly).
 Long Ridge (Stockwood's Long
 Ridge).
 Longest (Longest of All).
 Lorne (Marquis of Lorne).
 Lynch (Lynch's Star of the West).
 Medium Green (Nichol's Medium
 Green).
 Model (Carter's Model).
 Netted Russian (Early Netted
 Russian).
 Noas (Noas' Forcing).
 Norbiton (Norbiton's Giant).
 Paragon (Kelway's Paragon).
 Pearl (White Pearl).
 Peerless.
 Pera (Giant Pera).
 Perfect Pickling (O. K. Perfect
 Pickling).
 Prize Fighter.
 Rabley (Monroe's Rabley).
 Rand's White Spine (Rand's Im-
 proved White Spine).
 Russian (Early Russian).
 Serpent, or Snake. *Cucumis Melo*,
 var.
 Short Green (Gherkin).
 Sion House (Improved Sion
 House).
 Southgate (Long Green South-
 gate).

CUCUMBER, *continued.*

- Tailby (Tailby's Hybrid).
- Telegraph (Rollisson's Telegraph).
- Tender True (Tender and True).
- Turkey (Long Green Turkey).
- West India Gherkin, or Burr. *Cucumis Anguria.*
- White Dutch (Large White Dutch).
- White Slicing (Landreth's White Slicing).
- White Spine (Improved Early White Spine, Extra Long White Spine).

64 varieties.

DANDELION—

- American (American Improved).
- Broad-leaved.
- Cabbaging.
- Common.
- French Garden.
- Improved Early (Improved Very Early).
- Large-leaved.
- Moss Curled (Improved Moss Curled).
- Thick-leaved French.

9 varieties.

DILL—*Anethum graveolens.*DOCK—*Rumex*, several species.

EGG-PLANT—

- Black Pekin.
- Dwarf Round Purple (Early Dwarf Round Purple).
- Large Round Purple.
- Long Purple (Early Long Purple).
- Long White (Long White Chinese).
- Mammoth Purple.
- New Jersey (New Jersey Large Purple).
- New York (New York Improved).
- Round White (Large Round White).
- Scarlet Chinese.
- Scarlet-fruited.
- Striped, or Gaudaloupe.
- Tomato.
- White Egg-shaped.

14 varieties.

ENDIVE—

- Batavian (Broad-leaved Batavian).

- Escarole (Broad-leaved Escarole).
- French Moss (French Moss Curled, Fine-curved Mossy).
- Giant Fringed.
- Mammoth Curled (New Mammoth Green Curled).
- Summer Curled (Green Curled Summer).
- White Curled (Ever White Curled).
- Wild.
- Winter *Curled (Green Curled Winter).

9 varieties.

FENNEL—

- Common, *Feniculum vulgare.*
- Florence (Florence Celery-rooted). *F. dulce.*

GARLIC.

HORSE-RADISH.

HYSSOP—*Hyssopus officinalis.*ICE-PLANT—*Mesembryanthemum crystallinum.*

KALE, or BORECOLE—

- Brown German, or Purple (Brown German Curled).
- Carter (Carter's Garnishing).
- Chinese, or Pe-tsai.*
- Cottager (Cottager's).
- Dwarf Brown.
- Dwarf Early (New Dwarf Very Early).
- Dwarf Green (Dwarf Green Curled.)
- Dwarf Scotch (Dwarf Green Curled Scotch).
- Dwarf Purple.
- Erfurt (Dwarf Green Erfurt).
- Green German (German Dwarf Green).
- Green Scotch (Tall Green Curled Scotch).
- Half-dwarf Fringed.
- Imperial (Dreer's Imperial).
- Jersey (Large-leaved Jersey).
- Mosbach Winter.
- Moss-curved (New Moss-curved Very Early).

* *Brassica Sinensis.* Catalogued also under Cabbage.

KALE, OR BORECOLÉ, *continued.*

Norfolk (Norfolk Curled).
 Phoenix.
 Purple German (German Dwarf Purple).
 Purple Vienna (Early Purple Vienna).
 Red Scotch (Tall Red or Purple Scotch).
 Siberian (German Greens, or Sprouts).
 Spring.
 Striped (Striped Garnishing).
 Thousand-headed.
 Tree (Tall Tree).
 Variegated (Striped and Variegated).
 White Vienna (Early White Vienna).

29 varieties.

KOHLE RABI—

Erfurt (Earliest Erfurt).
 Goliath.
 Green.
 Late Purple (Late Purple Giant).
 Purple Vienna (Early Purple Vienna).
 Short-leaved Vienna (Early Short-leaved Vienna).
 White Vienna (Early White Vienna).

7 varieties.

LAVENDER—*Lavandula vera.*

LEEK—

American Flag (Large American Flag).
 Carentan (Large Carentan).
 Italian (New Giant Italian).
 London Flag (Broad London Flag).
 Musselburgh.
 Perpetual (Perpetual French).
 Rouen (Large Rouen).
 Scotch (Scotch Champion).

8 varieties.

LETTUCE—

Alexandria Cos (Alexandria White Cos).
 American Gathering.
 Asiatic (Asiatic Cabbage, Imperial, or Grand Admiral).

Balloon (New Balloon).
 Batavia (Batavia Brown Head).
 Beauty (American Beauty).
 Beauregard (Laciniated Beauregard).
 Black-seeded Butter (N. Y. Black-seeded Butter).
 Black-seeded Simpson.
 Blonde d' Ete.
 Bloomsdale (Bloomsdale Reliable).
 Bloomsdale Fringed (Bloomsdale Green Fringed).
 Bloomsdale Summer (Bloomsdale Early Summer).
 Bossin.
 Boston Market (White-seeded Tennis Ball).
 Boston Curled.
 Bronze Curled.
 Brown Dutch.
 Brown Genoa.
 Buttercup.
 Butterhead (Large Butterhead).
 California Butter (California Cream Butter).
 California Heart (California All Heart).
 Charter (New Charter).
 Chavigne (Early Chavigne).
 Chicago (Chicago Forcing).
 Curled India.
 Deacon.
 Defiance Cabbage.
 Defiance Summer.
 Drumhead, or Malta.
 Dwarf Green (Dwarf Green Very Early).
 Egg, or Forcing (Early Egg).
 Emperor (Emperor Forcing).
 Eureka.
 Everlasting.
 Frankfort (Frankfort Head).
 Golden Curl.
 Golden Head (O. K. Golden Head).
 Golden Heart (Burpee's Golden Heart).
 Golden Spotted.
 Grand Rapids (Grand Rapids Forcing).
 Gray-seeded Butter.

LETTUCE, *continued.*

- Green Fringed, or California
 Curled (New Green Fringed).
 Green Paris (Green Paris Cos).
 Hamilton (Hamilton Market
 Head).
 Hammersmith.
 Hanson.
 Hard Head.
 Hardy Winter (Hardy Green Win-
 ter).
 Hill (Hill Bronze Head).
 Hubbard (Hubbard Market).
 Ice (Ice Drumhead).
 Imperial (Imperial White Cab-
 bage).
 India (Large India).
 Kingsholm Cos.
 Landreth Cutting (Landreth's
 Earliest Cutting).
 Landreth Forcing (Landreth's
 Forcing).
 Largest (Largest of All).
 Mammoth Head (Price & Knicker-
 bocker's Mammoth Head).
 Mammoth Market.
 Marblehead (Marblehead Mam-
 moth).
 Marvel, or Red Besson.
 Midsummer.
 Mexican Cos (Giant Mexican Cos).
 Neapolitan (Neapolitan Cabbage).
 New York (Henderson's New
 York).
 New York Head.
 New York Market.
 Nonsuch.
 Nugget (Gold Nugget).
 Oak-leaf (American Oak-leaved).
 Ohio Cabbage.
 Ohio (Early Ohio).
 Onondaga.
 Orange County (Orange County
 Butter).
 Paris Sugar.
 Passion (Large Passion).
 Peach (New White Peach).
 Perpetual.
 Perpignan (Benary's Perpignan).
 Philadelphia (Philadelphia Butter).
 Premium (Premium Cabbage).
 Princess (Large Princess Head).
 Prize Head (Early Prize Head).
 Queen (Faust's New Queen).
 Randolph (Randolph's Favorite).
 Romaine (Romaine White Cos).
 Royal (Improved Royal Cabbage).
 Russian (New White Russian
 Summer).
 Salamander.
 Satisfaction, or Cut-leaf.
 Shotwell (Shotwell's Brown-head).
 Silesian (Early Curled Silesian).
 Silver Ball (Burpee's Silver Ball).
 Simpson (Early Curled Simpson).
 Spotted Cabbaging (Improved
 Spotted Cabbaging).
 Spotted Dutch (Early Dutch But-
 ter Spotted).
 St. Louis (St. Louis Market).
 Standwell, or Long Standing.
 Stone-head (Stone-head Golden
 Yellow).
 Stone Tennis-ball.
 Stubborn Feeder.
 Stubborn Head.
 Sugar Loaf.
 Superb (Superb Heat-resisting
 Cos).
 Surehead (P. W. & Co.'s Sure-
 head).
 Tomhannock.
 Tom Thumb.
 Versailles (Versailles Cabbage).
 Victoria.
 Waite (Waite's New Cabbage).
 White Curled (White Curled
 Head).
 White Forcing (White Forcing
 Head).
 White Paris (Paris White Cos).
 White Summer (Large White
 Summer Cabbage).
 Year Round (All the Year Round).
 Yellow Cos (Giant Yellow Cos).
 Yellow-seeded Butter (Improved
 Yellow-seeded Butter).
119 varieties.
 MARIGOLD, POT — *Calendula offici-*
nalis.
 MARJORAM, SWEET — *Origanum Mar-*
jorana—

MARJORAM, POT—*Origanum Onites*—

MARTYNIA—

Craniolaria.
Louisianian.
Proboscidea.

MUSHROOM—

English Spawn.
French Spawn.

MUSK MELON—

Algiers (Algiers Cantaloupe).
Arlington (Arlington Green Nutmeg).
Atlantic City.
Baltimore.
Banana (Banana Cantaloupe).
Bay View (Hybrid Bay View).
Bird (Bird Cantaloupe).
Black Paris (Large Black Paris).
Blenheim (Blenheim Orange).
Boston (Boston Nutmeg).
California (California Nectar).
California Citron.
Cape May (Extra Early Cape May).
Casaba, or Persian.
Cavaillon (Green-fleshed Cavaillon).
Champion (Champion Market, New Champion).
Chicago (Chicago Market Nutmeg).
Christiana.
Colorado Giant (Giant of Colorado).
Colorado Preserving.
Cream (Miller's Cream).
Delmonico.
De Passy.
Early Citron (Extra Early Citron).
Early Round Cantaloupe.
Emerald (Emerald Green).
Excelsior.
Favorite (Starin's Favorite).
Golden Gem.
Golden Jenny.
Golden Netted.
Golden Perfection.
Green Citron.
Green Climber.
Hackensack, or Turk's Cap.
Harris (Dr. Harris).
Heath (Monroe's Little Heath).

Hogg (Dr. Hogg).

Honey Citron (Honey Dew Green Citron).

Improved Cantaloupe.

Invincible (Invincible Scarlet).

Irondequoit.

Japan Coral-Flesh.

Japan (New Japan).

Jenny Lind.

June (Extra Early June).

Large Boston.

Large Yellow.

Little Gem.

Montreal Market.

Montreal Nutmeg (Montreal Green Nutmeg).

Neapolitan (Neapolitan Winter).

Netted Gem (O. K. Netted Gem).

Netted Green Citron.

New Orleans, or Creole (New Orleans Market).

Nutmeg.

Odella.

Orange Cream (New Orange Cream).

Orange (Vegetable Orange, Melon Apple, Vine Peach, Mango Melon).

Osage.

Perfection.

Persian (Persian Monarch).

Pineapple.

Pomegranate.

Portugal (Black Portugal).

Prescott, or Hardy Ridge.

Pride (Grower's Pride).

Princess.

Prolific.

Queen.

Reedland (Reedland Giant).

Salmon (Salmon and Green).

Shah, or Persian Monarch.

Sill (Sill's Hybrid).

Silver Netted.

Skillman (Skillman's Netted).

Spanish (Spanish Nectar).

Squire (The Squire).

Superior (New Superior).

Surprise.

Tom Thumb (Sutton's Tom Thumb).

MUSK MELON, *continued.*

Valencia.
 Vandalia.
 Ward (Ward's Nectar).
 White French (Large White French).
 White Japan.
 Yellow Ball (Yellow Ball Mango).
 Yellow Cantaloupe (Large Yellow Cantaloupe).
88 varieties.

MUSTARD—

Brown, or Black.
 Chinese Broad-leaved.
 Chinese Tuberos-rooted.
 Creole (Curled Creole).
 Golden.
 Southern (Southern Giant Curled).
 White American.
 White English.
 White London.
9 varieties.

NASTURTIUM, or INDIAN CRESS—

Dwarf.
 Dwarf Crimson.
 Dwarf Yellow.
 Tall.
 Tall Blood-colored.
 Tall Pickling.
 Tom Thumb (Dwarf Tom Thumb).
7 varieties.

OKRA, or GUMBO—

Common Southern.
 Density (Dwarf Prolific, New Dwarf Density).
 Dwarf White.
 Dwarf Green (Improved Dwarf Green).
 Gem (Dreer's Little Gem).
 Green Pod (Landreth's Long Green Pod).
 Long Green.
 New South.
 Tall.
 White Pod (Landreth's Long White Pod).
 White Velvet, or White Creole.
11 varieties.

ONION—

Adriatic (New Early Adriatic).

Adriatic Barletta (New Adriatic Barletta).
 African (Mammoth African).
 Aroostook (Early Aroostook).
 Bermuda Red.
 Bermuda White.
 Bristol (Bristol Early Red).
 California (California Early Red).
 Copper King.
 Cracker (Early Yellow Cracker).
 Danvers (Yellow Danvers).
 Danvers Globe (Yellow Globe Danvers).
 Danvers Flat (Danvers Yellow Flat).
 El Paso, or Mexican.
 Excelsior (Thorburn's Excelsior Pickling).
 Flat Red (Extra Early Flat Red).
 Golden Ball.
 Golden Tripoli (Golden Globe Tripoli).
 Golden Queen (New Golden Queen).
 Ivory Ball.
 Louisiana (Louisiana Creole).
 Madrid (Madrid Giant).
 Mammoth Silverskin.
 Mammoth Tripoli.
 Marzajola (Neapolitan Marzajola).
 Maze (New Maze).
 Michigan (Michigan Yellow Globe).
 Naples Rocca (Naples Giant Rocca).
 Nasbey (Nasbey's Mammoth).
 Nocera (Small White Nocera).
 Nutmeg (Nutmeg White Globe).
 Orange County (Orange County Red Globe).
 Paris (Paris Silver Skin).
 Pearl (American Extra Early Pearl).
 Philadelphia Yellow (Philadelphia Yellow Globe Danvers).
 Philadelphia White.
 Pompeii (New Mammoth Pompeii).
 Prizetaker.
 Queen.
 Radish (Early Radish).

ONION, *continued.*

Red Etna (Pale Red Etna).
 Red Garganus.
 Red Globe (Large Red Globe, Early Red Globe Danvers).
 Red Rocca (Giant Rocca, Giant Red Rocca).
 Red Teneriffe.
 Red Tripoli (Large Red Italian Tripoli).
 Round Danvers (Round Yellow Danvers, Early Round Danvers).
 Round Silverskin (Hard Round Silverskin).
 Seeding (Early Seeding).
 Silver Ball.
 Sixty-day (Salzer's Sixty-day).
 Southport Yellow (Southport Yellow Globe).
 Southport White (Southport White Globe).
 Southport Red (Southport Red Globe).
 Spanish King, or Prizetaker.
 St. Laurent (Brown St. Laurent).
 Vesuvius (Blood-red Vesuvius).
 Victoria (New Victoria).
 Victoria Red.
 Victoria White.
 Welsh Red. } *Allium fistulosum.*
 Welsh White. }
 Wethersfield (Wethersfield Large Red).
 White Barletta.
 White Bunch.
 White Dutch (White Dutch Pickling).
 White Etna (Silver White Etna).
 White Garganus.
 White Globe.
 White Pickling.
 White Pearl.
 White Portugal, or Silver Skin.
 White Queen (Earliest White Queen).
 White Teneriffe.
 White Tripoli (Large White Italian Tripoli).
 Yellow Dutch, or Strasburg.
 Yellow Egg (New Yellow Egg).

Yellow Rocca (Giant Yellow Rocca).

78 varieties.

ONION, SETS, TOPS, ETC.—

August (Dark Red August).
 Bloomsdale (Extra Early Bloomsdale Pearl).
 Button, or Top Onions.
 English Multiplier.
 Egyptian, or Perennial Tree.
 Garganus, or Ruby King (Mammoth Red Garganus).
 Golden Ball.
 Michigan Globe (Michigan Yellow Globe).
 Philadelphia (Philadelphia Silverskin).
 Potato.
 Red.
 Red Teneriffe.
 Red Rareripec (Small Red Rareripec).
 Round Silverskin (Round White Silverskin).
 White.
 White Multiplier (New White Multiplier).
 White Rareripec (Small White Rareripec).
 White Teneriffe.
 Yellow.
 ORACH, or FRENCH SPINAGE—*Atriplex hortensis*—
 Red.
 White.
 PARSLEY—
 Champion (Champion Moss Curled).
 Covent Garden (Covent Garden Garnishing).
 Double Curled (Extra Double Curled).
 Dunnet (Dunnet's Selected).
 Dwarf Curled.
 Dwarf Massed (Dwarf Fine Massed).
 Emerald.
 Enfield (Enfield Matchless).
 Fern-leaved.
 Garnishing.
 Hamburg, or Turnip-rooted.

PARSLEY, *continued.*

Market Garden.
 Market Gardener (Market Gardener's Best).
 Parterre (Beauty of the Parterre).
 Perpetual (Extra Curled Perpetual).
 Plain.
 Puritan (Beauty of the Puritan).
 Triple Curled (Fine Triple Curled).
18 varieties.

PARSNIP—

Abbot (Abbot's Improved).
 Bloomsdale.
 Early Round.
 Fine Sugar.
 Dutch (Large Dutch).
 Guernsey (Improved Guernsey).
 Ideal (New Ideal Hollow Crown).
 Jersey (Large Jersey).
 Long Smooth, or Hollow Crown.
 Long Island (Long Island Hollow Crown).
 Maltese.
 Perfection (Pearce's Perfection).
 Round French (Short Round French).
 Salzer (Salzer's New White).
 White Sugar (Long White Sugar).
15 varieties.

PEA—

Abundance (Bliss' Abundance).
 Advancer (McLean's Early Advancer).
 Advance (McLean's Advance).
 Alaska.
 Albany (Duke of Albany).
 Allen (Allen's Superb).
 Alpha (Laxton's Alpha).
 American Champion.
 American Wonder.
 Aroostook Marrowfat.
 Bergen (Bergen Fleet Wing).
 Bishop Dwarf (Bishop's Dwarf).
 Black Eyes.
 Black-eyed Marrowfat, or Peruvian.
 Bloomsdale.
 Blue Beauty
 Blue Gem.

Blue Imperial (Dwarf Blue Imperial).
 Blue Mohawk.
 Blue Peter (McLean's Blue Peter).
 Blue Prussian.
 Bride (Macbeth's Bride).
 British Queen (Champion of Scotland).
 Buist Premier (Buist's Premier Extra Early).
 Buridge (Buridge Eclipse).
 Burpee Extra Early (Burpee's Best Extra Early).
 Cable.
 Caractacus.
 Champion (Champion of England).
 Chelsea.
 Clipper (Rawson's Clipper).
 Conqueror (Payne's Conqueror).
 Cornish (Cornish's Early).
 Currie Challenge (Currie's Extra Early Challenge).
 Delicious.
 Dexter.
 Dwarf Champion.
 Dwarf Gray Sugar (Dwarf Gray-seeded Sugar).
 Dwarf Mammoth.
 Dwarf Marrowfat.
 Dwarf Prize (Reed's Early Dwarf Prize, Reed's Early Prize).
 Dwarf Sugar (Early Dwarf Wrinkled Sugar).
 Earliest Best (Earliest and Best).
 Early French.
 Early May.
 Ely (Ely's Extra Early).
 Eugenie, or Alliance.
 Epicure.
 Eureka (Dreer's Eureka).
 Everbearing (Bliss' Everbearing).
 Evolution (Laxton' Evolution).
 Excelsior (Breck's Excelsior).
 Extra Early.
 Faust's Extra Early (Faust's Selected Extra Early).
 Ferry's Extra Early (D. M. Ferry & Co.'s Extra Early).
 Fillbasket.
 First (First of All).
 First Best (First and Best).

PEA, *continued.*

- First Crop (Carter's First Crop).
 First Market (Livingston's First
 in the Market).
 Forty-two Days (Perry's Forty-
 two Days).
 Forty-fold.
 Frame (Early Frame).
 French Canner.
 French Sugar (Dwarf White
 French Wrinkled Sugar).
 Golden Gem.
 Hampden (Hampden Earliest).
 Hancock.
 Harrison (Harrison's Glory).
 Hartford (Early Hartford).
 Henderson's First (Henderson's
 First of All).
 Hogg (Dr. Hogg).
 Invincible (Sharpe's Invincible).
 Iowa Challenge (Iowa's Chal-
 lenge).
 J. & S. Extra Early.
 John Bull.
 Kent (Early Kent).
 Kentish Invicta.
 King Dwarf (King of the Dwarfs).
 Landreth's Extra Early.
 Laxton Earliest (Laxton's Earliest
 of All).
 Laxton Prolific (Laxton's Prolific).
 Leonard's First (Leonard's First
 and Best of All).
 Lightning.
 Little Gem (McLean's Little
 Gem).
 Long Island (Long Island Mam-
 moth).
 Long Pod (Bishop's Long Pod).
 Magog (Early Magog).
 Market Garden (Horsford's Mar-
 ket Garden).
 Market Pride (Pride of the Mar-
 ket).
 Marrowfat.
 Marrow King (King of the Mar-
 rows).
 Marvel (Laxton's Marvel).
 Maud S.
 Maule Earliest (Maule's Earliest
 of All).
 Maule Extra Early (Maule's Extra
 Early).
 McBeth (McBeth's Pride).
 McLean (Dr. McLean).
 Melting Sugar.
 Midsummer (Henderson's Mid-
 summer).
 Minimum.
 Morning Star (Buist's Early Morn-
 ing Star).
 Napoleon.
 Nellis Premier (Nellis' Premier).
 Ne Plus Ultra.
 New Dominion.
 Orange County (Orange County
 Early Morning Star).
 O'Rourke (Improved Daniel O'-
 Rourke).
 Paragon (Sharpe's Early Paragon).
 Pearl (Extra Early Pearl).
 Perfection (Veitch's Perfection).
 Perpetual (Walker's Perpetual).
 Peruvian, or Black-eyed Marrow.
 Philadelphia (Philadelphia Extra
 Early).
 Pioneer.
 Plant's Extra Early.
 Premium (Extra Early Premium
 Gem).
 Prizetaker.
 Profusion (Burpee's Profusion).
 Quality (Burpee's Quality).
 Quantity (Burpee's Quantity).
 Reliance (Everitt's Reliance).
 Royal Marrowfat (Royal Dwarf
 White Marrowfat).
 Rural New-Yorker (Cleveland's
 Rural New-Yorker).
 Salzer's Earliest Best (Salzer's
 Earliest and Best).
 Sander's Marrow.
 Satisfaction (Sutton's Satisfac-
 tion).
 Short-straw Marrow.
 Stratagem.
 Sunrise (Day's Sunrise).
 Superlative (Laxton's Superlative).
 Supreme (Laxton's Supreme).
 Tall Gray (Tall Gray-seeded
 Sugar).
 Tall Sugar (Tall Butter Sugar).

PEA, *continued.*

Telegraph.
 Telephone.
 Thorburn Market (Thorburn's
 Extra Early Market).
 Tom Thumb.
 Triumph (Sharpe's Triumph).
 Universal (Childs' Universal).
 Vermont Wonder (Vermont Won-
 der Gem).
 Vick's Extra Early.
 Victoria Marrow.
 Wales (Prince of Wales).
 Washington (Early Washington).
 White Marrowfat.
 William First (Laxton's William
 First).
 Wilson (Wilson G. F.).
 Wilson Extra Early (Wilson's Im-
 proved Extra Early).
 Wm. Hurst.
 Wonder (Wonder Gem).
 Wrinkled Sugar.
 Yorkshire Gem.
 Yorkshire Hero.
154 varieties.

PEPPER—

Boston Squash.
 Celestial.
 Cherry Red.
 Cherry-form (Cherry-formed.)
 Cheese.
 Chili.
 Coral Gem (Coral Gem Bouquet).
 Cranberry.
 Dawn (Golden Dawn).
 Dwarf Squash (Dwarf Early Red
 Squash).
 Emperor (Giant Emperor).
 Golden Bell.
 Golden Dwarf.
 Golden Upright.
 Japan (Japan Cluster).
 Large Bell, or Bull Nose.
 Long Red (Long Red Cayenne).
 Long Yellow (Long Yellow Cay-
 enne).
 Monstrous, or Grossum.
 Mountain (Sweet Mountain, or
 Mammoth).
 Orange (Orange Mammoth Sweet).

Oxheart.
 Procopp (Procopp's Giant).
 Queen (Mammoth Golden Queen).
 Red Cluster.
 Red Upright.
 Ruby King.
 Spanish (Spanish Monstrous).
 Squash, or Tomato-shaped.
 Sweet Spanish.
 Yellow Chili.
 Yellow Mango (Mammoth Yellow
 Sweet Mango).
32 varieties.

POTATO—

Acme.
 Addison.
 Adirondack.
 Advance (Hovey's Advance).
 Albino (Early Albino).
 Aldine.
 Alexander (Alexander's Prolific).
 Alexander's No. 1.
 Alexander's No. 103.
 Algerino.
 Alpha.
 Altamont.
 Alligator.
 Amazon.
 American Champion (Champion
 of America).
 American Giant.
 American Pride (Pride of
 America).
 Amsterdam.
 Andrus (Andrus White Rose).
 Angell's No. 79.
 Angell's Eureka.
 Antwerp.
 Arabian.
 Arctic.
 Arizona Wild.
 Arkansas (Arkansas Rose).
 Arlington.
 Aroostook.
 Arundel (Arundel Rose).
 Ash-leaf Kidney.
 Ash-top (Ash-top Flake).
 Astonisher.
 Atlantic.
 Athens (Monarch of Athens).
 August (August Flower).

POTATO, *continued.*

- Baby Elephant.
 Badger State (New Badger State).
 Baker (Baker's Seedling).
 Banana.
 Baraboo (Baraboo White).
 Barrows (Barrows' Perfection).
 Barstow.
 Bashaw.
 Bath (Wonder of Bath).
 Beauty (Beauty of Beauties).
 Behemoth.
 Belle.
 Benefit (Big Benefit).
 Ben. Harrison.
 Berkshire.
 Bermuda.
 Bill Nye.
 Bingham.
 Binn (Binn's Seedling).
 Biscuit.
 Bismarck.
 Blackfriar.
 Black Christie.
 Black Jack.
 Black Machanac.
 Black Mercer.
 Black Neshannock.
 Black Prince.
 Black Republican.
 Black Rose.
 Blaine (James G. Blaine).
 Bliss No. 12.
 Bliss No. 30.
 Bliss No. 39.
 Bliss No. 51.
 Blood.
 Blood-heart.
 Blue-blush (Rose's Blue-blush).
 Blue Cow-horn.
 Blue Elephant.
 Blue Mayflower.
 Blue Pearl.
 Blue Point.
 Blue-eyed Peach-blow.
 Blue Victor.
 Bodega (Bodega Red).
 Bonanza.
 Bon Bon.
 Bonnell (Bonnell's Seedling).
 Bonnell Best (Bonnell's Best),
 Boston Blue.
 Boston Cracker.
 Boston Market.
 Brazilian.
 Bread-fruit.
 Breakfast.
 Breeze (Breeze's Red).
 Bright Eyes.
 Bristol Baker.
 Brook (Brook's Seedling).
 Brown Beauty
 Brownell Beauty (Brownell's
 Beauty).
 Brownell Best (Brownell's Best).
 Brownell Success (Brownell's Suc-
 cess).
 Brownell Superb (Brownell's Su-
 perb).
 Brownell Superior (Brownell's Su-
 perior).
 Brownell's No. 31.
 Brownell's No. 55.
 Brunswick.
 Buffalo (Buffalo Beauty).
 Buffalo Bill.
 Buffet.
 Burbank.
 Burbank Sport.
 Burling.
 Burpee Early (Burpee's Extra
 Early).
 Burpee Superior (Burpee's Supe-
 rior).
 Burrough's Garfield.
 Calico.
 California Mercer.
 Callao.
 Calumet.
 Cambridge (Cambridge Prolific).
 Canada Seedling.
 Canada White.
 Canadian.
 Cap Sheaf.
 Captain.
 Capricorn.
 Caracus.
 Carpenter (Carpenter's Seedling),
 Carlisle (Duke of Carlisle).
 Carter.
 Carter Blotch (Carter's Blotch).
 Carter Early (Carter's Early).

POTATO, *continued.*

- Castilian.
 Cataract.
 Cayuga.
 Cayuga Chief.
 Centennial.
 Central American (wild).
 Cetewayo.
 Chatfield (Chatfield's Seedling).
 Challenge.
 Champion.
 Champlain.
 Chautauqua.
 Charles Downing.
 Charter Oak.
 Cheesman (Cheesman's Seedling).
 Chelli Red.
 Cherokee.
 Cherry Blow.
 Cheshire.
 Chicago Beauty.
 Chicago Gem.
 Chicago Market.
 Chicago Sun.
 Chief.
 Child's North Pole.
 Chili Blush.
 Chili Pinkeye.
 Chilian Pink.
 China Prince.
 Chiticatica.
 Churchill (Churchill's Seedling).
 Clark No. 1 (Clark's No. 1).
 Cleveland (President Cleveland).
 Clifton.
 Clipper.
 Clipper Red (Clipper's Red).
 Climax.
 Coldstream.
 Collin (Collin's Excelsior).
 Collum (Collum's Superb).
 Colorado No. 1.
 Columbia.
 Colvin Excelsior (Colvin's Excelsior).
 Colvin Prize (Colvin's White Prize).
 Colvin Superb (Colvin's Superb).
 Comanche.
 Comforter.
 Commander.
 Compton (Compton's Surprise).
 Con (Con's Seedling).
 Concord.
 Conebrook (Conebrook's Seedling).
 Connecticut.
 Conneaut.
 Conqueror.
 Conquest.
 Constitution.
 Continental.
 Cook (Cook's Superb).
 Cook Choice (Cook's Choice).
 Coppermine.
 Corless (Corless' Matchless).
 Cornell Kidney (Cornell's Kidney).
 Corona (Corona Beauty).
 Corean.
 Corean Red.
 Cosmopolitan.
 Cow Horn.
 Crandall (Crandall's Seedling).
 Cr a n d a l l Beauty (Crandall's Beauty).
 Crawford (Crawford's Seedling).
 Cream (Cream of the Field).
 Creedmoor.
 Creelston.
 Crimson Beauty.
 Crown Imperial.
 Crown Jewel.
 Cuban King.
 Cuban Peachblow.
 Dairy.
 Dakota Boss.
 Dakota Red.
 Dakota White.
 Dandy.
 Date (Date Early).
 Dawn (Dawn Early).
 Davenport (Davenport Seedling).
 Dayspring.
 Defiance.
 Delaware.
 Delmahoy.
 Derby.
 Desert Rose.
 Dictator.
 Dixie.
 Dolphin.

POTATO, *continued.*

- Domestic.
 Donganeil (Donganeil's Beauty).
 Door Yard.
 Dover.
 Dr. White.
 Dreer (Dreer's Standard).
 Drew.
 Druid.
 Drummond.
 Dublin Chief.
 Dúchess.
 Dunham (Dunham Early).
 Dunmore Blush.
 Dunmore (Dunmore's Seedling).
 Dunster.
 Durham (Durham Early).
 Durkman.
 Dustin (Dustin Early).
 Dutch Merino.
 Dykeman.
 Dyrite.
 Early Hebron (Early Beauty of Hebron).
 Early King (Lady of London, London Lady).
 Early Market.
 Early Ohio.
 Early Rose.
 Eastern Star.
 Eclipse.
 Eclipse Early.
 Edinburgh (Duke of Edinburgh).
 Egyptian.
 1889.
 Electric.
 Electric Early.
 Eight Weeks (Carter's Eight Weeks).
 Eldorado.
 Elgin (Lady Elgin).
 Elkland.
 El Paso.
 Empire State (Burpee's Empire State).
 English Champion.
 English Early.
 English Magnum Bonum.
 English Peachblow.
 English Red.
 English Rose.
 English Snowflake.
 Eno (Eno's Seedling).
 Eno Kidney (Eno's Kidney).
 Enterprise.
 Essex Early.
 Ethiopian.
 Eureka.
 Eutaw.
 Evening Star.
 Everitt.
 Everitt Market (Everitt's Early Six-weeks Market).
 Excelsior.
 Eximius.
 Eyeless (New Eyeless Seedling).
 Falcon.
 Farina.
 Farmer (Farmer's Seedling).
 Farmer Delight (Farmer's Delight).
 Farmer Favorite (Farmer's Favorite).
 Faust's No. 1.
 Fawn.
 Fearnought.
 Field Pride (Pride of the Field).
 Field Queen (Queen of the Field).
 Fillbasket.
 Finch (Finch's Early Perfection).
 First Best (First and Best).
 Fisherman.
 Fleetwood.
 Flemish Beauty.
 Flesh-colored.
 Florida (Florida Russet).
 Flour Ball (Sutton's Flour Ball).
 Fluke.
 Fold Fluke.
 Foraker (Gov. Foraker).
 Forforshire Red.
 Fortune.
 Fox Eye.
 French Fluke.
 French Giant.
 French Kidney.
 French Marine.
 Galva.
 Gardener (Gardener's Early Seedling).
 Garfield.
 Garnet Chili.

POTATO, *continued.*

- Garrison's No. 8.
 Gazelle.
 Gem.
 Gem Early (Vick's Early Gem).
 George III.
 George Late.
 George Rose.
 Gladstone.
 Glasgow.
 Gleason.
 Gold Drop.
 Gold (Gold's White).
 Golden Ball.
 Golden Early.
 Golden Flesh.
 Golden Perfection.
 Golden Russet.
 Goodrich Early.
 Grampian (Grampion Russet.)
 Grange.
 Granger.
 Great Britain.
 Great Eastern.
 Green Mountain.
 Gregory.
 Grover Cleveland.
 Guatamala (wild).
 Gumbo.
 Gypsy.
 Hall Peach-blow (Hall's Early
 Peach-blow.)
 Hampden (Hampden's Beauty).
 Harbinger.
 Harlequin.
 Hartford Prolific.
 Harvest Early.
 Harvest Home.
 Hawaii.
 Hawkeye.
 Hemlock.
 Hendricks.
 Hepsworth (Hepsworth's Beauty).
 Herald.
 Hero (Green's Hero).
 Highlander.
 Holborn.
 Hollander.
 Home Comfort.
 Honey Dew.
 Honduras.
 Household.
 Household Early.
 Howard.
 Huebner (Huebner's Kidney).
 Huguenot.
 Huntington (Huntington's Seed-
 ling).
 Illinois Early.
 Indian White.
 Interior.
 Intermediate.
 Invincible.
 Ionia (Ionia Beauty)
 Iowa (Iowa Beauty).
 Irish American.
 Irish Cup.
 Irish Early.
 Irish Gray.
 Irish Prince.
 Irish Red.
 Irish Russet.
 Irish Surprise.
 Irish White.
 Irish Wonder.
 Ironclad.
 Ironsides.
 Iroquois.
 Italian (Italian Beauty).
 Jackson (Jackson White).
 James Vick.
 Japan Wild.
 Jardin Prolific (Jardin's Prolific.)
 Java.
 Jersey Blue.
 Jersey Lily.
 Jerusalem.
 Jewel.
 John Bright.
 Johnson (Johnson's Seedling).
 Johnes' No. 4.
 Johnes' No. 8.
 Jonathan (Brother Jonathan).
 Joseph Rigault.
 Judson (Judson's Favorite).
 Jumbo.
 June (Alexander's June).
 June Eating (Crane's June Eat-
 ing).
 Junkis.
 Junks (Putman's Junks).
 Kohinoor.

POTATO, *continued.*

- Kansas.
 Keeper (Crane's Keeper).
 Keepsake.
 Kepo.
 Kent.
 Keystone.
 Kidney.
 King (King's Excelsior).
 Knoxville.
 Lackawanna.
 Lady Finger.
 Laing (Laing's Seedling).
 Lake Erie.
 Lake Ontario.
 Landreth Garfield (Landreth's
 Garfield).
 Laplander.
 La Plume.
 Lapwing.
 Late Favorite.
 Late Goodrich.
 Late Hebron (Late Beauty of
 Hebron).
 Late Hoosier.
 Late Ohio.
 Late Rose.
 Late Shaw.
 Late Superior.
 Late Vermont.
 Ledding (Ledding's Seedling).
 Lee Favorite (Lee's Favorite).
 Lee Prolific (Lee's Prolific).
 Legal Tender.
 Leo (Leo XIII).
 Leviathan.
 Lewiston.
 Lincoln (President Lincoln).
 Lincoln Red.
 Little Giant.
 Lisbon Pride (Pride of Lisbon).
 Loange.
 Logan (General Logan.)
 Lombard.
 London.
 Long Mercer.
 Long Pinkeye.
 Louisiana Burbank (Louisiana
 Fall Burbank).
 Lubeck.
 Luxury.
 Magenter (Star of Magenter).
 Magic (Early Magic).
 Magnolia.
 Magnum Bonum (American Mag-
 num Bonum).
 Maiden Blush (Maiden's Blush).
 Maidstone.
 Maine Early.
 Maine State (State of Maine).
 Mameluke.
 Mammoth Prolific (O. K. Mam-
 moth Prolific).
 Manitoba.
 Manhattan.
 Marblehead.
 Marchmoor.
 Market (Early Market).
 Market Pride (Pride of the Mar-
 ket).
 Mars.
 Marshall.
 Marvel (Marvel of Beauty).
 Mason Pride (Pride of Mason).
 Matchless.
 Mayflower.
 Mayflower Early.
 McClellan (General McClellan).
 McCormick.
 McFadden.
 McNally (McNally's Seedling).
 Mecklenburgh.
 Mediterranean.
 Medly.
 Medona (Medona Early).
 Mercer (Mercer Early).
 Merino.
 Merrimac.
 Merritt (Ben. Merritt).
 Mexican Giant.
 Mexican Merino.
 Michigan.
 Michigan Red.
 Mikado.
 Miller (Miller's Seedling).
 Minister.
 Minnesota (Early Minnesota).
 Mississippi.
 Mitchell (Mitchell's Seedling).
 Mock Sweet.
 Mohawk Early.
 Monarch (American Monarch).

POTATO, *continued*.

- Monitor.
 Monroe (Monroe Seedling).
 Monroe Prize (Monroe Country Prize).
 Montana Rose.
 M o n t a n a (West's M o n t a n a Beauty).
 Montreal.
 Morn Early.
 Morning Star.
 Morrell (Morrell's Seedling).
 Morris White.
 Mountain Prolific.
 Mountain Queen.
 Mountain Rose.
 Mountain Sprout.
 Mrs. Cleveland.
 Mrs. Foraker.
 Mullally.
 Multiplier.
 Munson (Munson's Seedling).
 Murray (Murray's Gold-Flake).
 Muscovite.
 Mustapha.
 Narragansett.
 Nashville.
 Nathan Rose.
 National.
 Nebraska (Pride of Nebraska).
 Nepaugh.
 Neshannock.
 Nevada (Nevada White).
 N e w E n g l a n d (New England Beauty).
 New England Far.
 New Eyeless.
 New Hampshire.
 Newland.
 Newton (Newton's Seedling).
 New York (New York State).
 New York Market.
 New York Red.
 New York White.
 New Zealand.
 New Zealand Early.
 Nigger Toe.
 Nigh (Nigh's Early Standard).
 Nonpareil.
 Norman.
 North Pole (Hall's North Pole).
 North Star.
 Northern Spy (Boley's Northern Spy).
 Norway.
 Nott (Nott's Victor).
 Nova Scotia Rose (Nova Scotia Early Rose).
 Nubian.
 Odd Fellow.
 Ogden (Ogden Beauty).
 Ohio Beauty.
 Ohio Fancy.
 Ohio Junior.
 Ohio Pinkeye.
 Ohio Rose.
 O K (New O K).
 Olympia.
 Oneida.
 Oneida Peachblow.
 Ontario.
 Orange.
 Orange County (Orange County White).
 Oswego (Oswego Wonder).
 Oseola (Giant Oseola).
 Otto.
 Overpaugh's Pinkeye.
 Oxford (Early Oxford).
 Ox Horn.
 Ozark.
 Pacific.
 Paddy (Paddy's Surprise).
 Palestine.
 Pamphylia.
 Paragon.
 Parson (Parson's Prolific).
 Patterson (Patterson's Irish Blue).
 Poughkeepsie Pride (Pride of Poughkeepsie).
 Poughkeepsie White.
 Peach Blossom.
 Peachblow.
 Peachblow Pinkeye.
 Pearce (Pearce Seedling).
 Pearl (Mammoth Pearl).
 Pearl Early.
 Pecan.
 Peck (Peck's Sun).
 Peerless.
 Pennsylvania (P e n n s y l v a n i a Belle).

POTATO, *continued.*

- Penn (Penn's Search Warrant).
 Perfect Gem.
 Perfect Peachblow.
 Perfection.
 Persian Baker.
 Persian Monarch.
 Persian Red.
 Peruvian (wild).
 Philadelphia.
 Phil. Sheridan.
 Phoenix.
 Pike's Peak.
 Pink (Pink of Perfection).
 Pinkeye.
 Planet.
 Plum.
 Plymouth Rock.
 Polaris.
 Pootatuck.
 Portage.
 Potentate (Crane's Potentate).
 Portland Russet.
 Potomac Climbers.
 Prairie Farmer.
 Prairie Flower.
 Prairie Giant.
 Premier.
 Premium (Home's Premium).
 President.
 Price (Geo. H. Price).
 Prince Albert (Canada Prince Albert).
 Prince Edward Rose (Prince Edward Island Rose).
 Princess.
 Primrose.
 Prize.
 Prize-taker (Jones' Prize-taker).
 Prodigy.
 Prolific.
 Providence.
 Puritan Early, or No. 49.
 Putnam.
 Putnam Favorite (Putnam's Favorite).
 Quar (Quar's Gem).
 Queen (New Queen).
 Queen Rose (Queen of the Roses).
 Queen Valley (Queen of the Valley).
 Queen Victoria
 Quimby (Quimby's Seedling).
 Quito.
 Quohaug.
 Rand's No. 41.
 Rand's Peachblow.
 Rand Red (Rand's Red).
 Rareripe.
 Red Cow-horn.
 Red Elephant.
 Red Essex.
 Red Fluke.
 Red Jacket (Seneca Red Jacket).
 Red Lady-finger.
 Red Lion.
 Red Mercer.
 Red Pearl.
 Red Peerless.
 Red Snowflake.
 Red Star.
 Red Superior.
 Red Ulink.
 Rennselaer (Rennselaer Chief).
 Rhinebeck.
 Ricker (Ricker's Giant).
 Riley.
 Rising Sun.
 Rochester (Rochester Seedling).
 Rochester Favorite (Rochester's Favorite).
 Rocket.
 Rockford.
 Rockland.
 Rocky Mountain (Rocky Mountain Rose).
 Rogers (Rogers' Seedling).
 Rogers' No. 4.
 Rogers' No. 7.
 Roman Red.
 Rose Giant.
 Rose Magnum Bonum.
 Rose New (Rose's New).
 Rose No. 74 (Rose's No. 74).
 Rosy Morn.
 Rough Diamond (Bliss' Rough Diamond).
 Round Pinkeye.
 Roxanna.
 Roxbury.
 Royal Gem.
 Royal Purple.

POTATO, *continued.*

- Royal Red.
 Royal Rhode.
 Rubicund.
 Rural.
 Rural Blush.
 Rural Buttercup.
 Rural New-Yorker No. 2.
 Russet (Jordan's Early Russet).
 Russet King (King of the Russets).
 St. Patrick.
 Salt Lake (Salt Lake Queen).
 Samaritan.
 Saturn.
 Savoy (Pearl of Savoy).
 Saxon.
 Scotch. (Unnamed sorts imported
 for consumption from Scotland
 and planted in many parts.)
 Scotch Blues.
 Scottish Champion.
 Sedan.
 Seek-no-further.
 Seneca Beauty.
 Seneca Chief.
 Seneca Wonder.
 Shady.
 Shakery Russet.
 Shaw (Shaw Early).
 Sheridan (General Sheridan).
 Siberian.
 Siloam.
 Silver Crest.
 Silverlake.
 Silver Skin.
 Skerry Blue.
 Smith Late Rose (Smith's Late
 Rose).
 Snow Bank (Knapp's Snow Bank).
 Snow Fairy.
 Snowflake.
 Snowflake Early.
 Snow Queen.
 Sovereign.
 Spanish Marx.
 Spartan.
 Spaulding (Spaulding's Seedling).
 Spotted Neshannock.
 Spotted Shaw.
 Squaw.
 Standard.
 Standard Early.
 Stanton.
 Star Russet.
 Stark (General Stark).
 Steel Red (Steel's Red).
 Steuben Beauty (Steuben's
 Beauty).
 Steuben Chief.
 Storr (Storr's Red).
 St. Paul (Pride of St. Paul).
 Strawberry (Late Strawberry).
 Strawberry Mercer.
 Strong (Strong's Imperial).
 St. Stephen.
 Sukreta.
 Sultan.
 Summit.
 Sunbeam.
 Sun Dog.
 Sunlit Star.
 Sunrise.
 Superior.
 Sutton Kidney (Sutton's Extra
 Kidney).
 Suwanee.
 Swamp Angel.
 Sweden (King of Sweden).
 Sweepstake.
 Sweet (Sweet's Early).
 Sylvan.
 Table (Pride of the Table).
 Tamarind.
 Tasmania.
 Telegraph.
 Telephone.
 Telephone Early.
 Tennessee.
 Tennessee White.
 Terhune.
 Thorburn (Thorburn's Late Rose).
 Thoroughbred (Early Thorough-
 bred).
 Thunderbolt.
 Tilden.
 Tioga Polite.
 Tipperary.
 Tonhochs.
 Trade Mark.
 Traveler.
 Tremont.
 Trescott (Lady Trescott).

POTATO, *continued.*

- Tresher (Tresher's Seedling).
 Triumph (Bliss' Triumph).
 Trophy.
 Trotter.
 Troy Market.
 Tunix.
 Twilight.
 Tyrian Purple.
 Valentine.
 Valley Chief.
 Valley Gem (Gem of the Valley).
 Valley Pride (Pride of the Valley).
 Valley Queen.
 Vandervere.
 Vanguard.
 Velvet Skin.
 Vera Cruz.
 Vergennes.
 Vermont Champion.
 Vermont Early.
 Vermont Fancy.
 Vermont Favorite.
 Veteran.
 Vick Early (Vick's Extra Early).
 Vick Prize (Vick's Prize).
 Vick Peachblow (Vick's Improved
 Peachblow).
 Vicksburg.
 Victory.
 Village (Village Blacksmith).
 Violet.
 Vizier.
 Wall (Wall's Orange).
 Wandering Jew.
 Washington.
 Watson (Watson's Seedling).
 Waverly.
 Webb (Webb's Early).
 Webster (Lady Webster).
 Weld's No. 2.
 Wells (Wells' Seedling).
 Wells Cross (Wells' Hybrid).
 Western Peerless.
 Western Pride (Pride of the
 West).
 Western Red.
 White Australian.
 White Bermuda.
 White Chief.
 White China.
 White Cloud.
 White Diamond.
 White Elephant.
 White Flower.
 White Granger.
 White Hebron (White Beauty of
 Hebron).
 White Kidney.
 White Lily.
 White Lion.
 White Magic.
 White Mammoth.
 White Monitor.
 White Mountain.
 White Prize Early.
 White Rose.
 White Sport.
 White Sprout.
 White Star.
 White Superior.
 White Surprise.
 White Victor.
 White Whale.
 White Whipple.
 Wig Wag.
 Willey's No. 10.
 William Fox.
 William Penn.
 Winslow (Winslow Seedling).
 Wisconsin Beauty.
 Wisconsin Peachblow.
 Wisconsin Pride (Pride of Wis-
 consin).
 Yam.
 Yankee Flat.
 Yankee Notion.
 Yankee White.
 Yarrow.
 Yellow Elephant.
 Yelder (Everlasting Yelder).
 Yosemite.
 Yuba.
 Yucatan.
 Zebra.
 Zephyr.
 Zig-zag.
 Zoar.
 Zoo.
 Zulu.

- PUMPKIN—(*Some of these varieties are also catalogued with Squashes*)—
- Banana.
 - Black Sugar.
 - Boulogne (Gray Boulogne).
 - Brazilian Sugar.
 - Cashaw, or Cushaw.
 - Common Field.
 - Connecticut Field.
 - Dunkard Winter.
 - Etampes Red (Etampes Mammoth Red).
 - Fifty Dollar (Fifty Dollar Prize).
 - Golden Yellow (Golden Yellow Mammoth).
 - Golden Oblong.
 - Golden Mammoth (New Golden Mammoth).
 - Green Striped, or Improved Cashaw.
 - Indiana Field (Indiana Corn Field).
 - Japan Crookneck.
 - Japanese Pie.
 - Jonathan.
 - Jumbo.
 - Large Cheese.
 - Large Tours, or Mammoth.
 - Mammoth King (King of the Mammoths).
 - Mammoth Potiron.
 - Mammoth Prize.
 - Michigan (Michigan Mammoth).
 - Monmouth (Monmouth County Golden).
 - Mammoth French.
 - Nantucket, or Negro.
 - Possum Nose.
 - Quaker Pie (Burpee's Quaker Pie).
 - St. George.
 - Sugar.
 - Tennessee (Tennessee Sweet Potato).
 - Tree.
 - Valparaiso.
 - West India (West India Mammoth).
 - Sweet Potato (Yellow Sweet Potato).
- 37 varieties.*
- RADISH—
- Alaska.
 - All-Seasons.
 - Black Spanish (Long Black Spanish).
 - Black Summer (Black Summer Turnip).
 - Box (White Box).
 - Burpee (Burpee's Earliest).
 - Button (Scarlet Button).
 - California Winter (California Mammoth White Winter).
 - Cardinal Globe.
 - Carmine Olive (Earliest Carmine Olive-shaped).
 - Celestial.
 - Chartier (Beckert's Chartier, Improved Chartier).
 - Chinese Rose (Chinese Rose Winter).
 - Chinese Scarlet (Scarlet Chinese Winter).
 - Covent Garden.
 - Dayton.
 - Earliest.
 - Early Mammoth.
 - El Dorado.
 - Fireball.
 - Forcing (Rapid Forcing).
 - Forcing Turnip (Red Forcing Turnip).
 - French Breakfast.
 - Garnet (Early Garnet).
 - Giant Stuttgart (Giant White Stuttgart).
 - Golden Globe.
 - Gray Summer.
 - Gray Winter (Long Gray Winter).
 - Half-long Scarlet (Half-long Deep Scarlet).
 - Lady Finger (White Lady Finger).
 - Long Purple.
 - Ne Plus Ultra.
 - Newcom.
 - Oval Red (New Early Oval Dark Red).
 - Paris (Paris Beauty).
 - Perpetual (Perpetual White Summer).
 - Purple Olive.

RADISH, *continued.*

Purple Summer (Purple Summer Turnip).
 Rat-tailed—*Raphanus sativus* var. *caudatus*.
 Red Ball.
 Red-crowned (Long White Red-crowned).
 Rocket (Red Rocket).
 Rose Olive (Olive-shaped Rose).
 Rosy Gem (New Rosy Gem).
 Round Spanish (Round Black Spanish).
 Round Red (Early Round Dark Red).
 Round Stuttgart (Stuttgart Round White).
 Salmon.
 Scarlet Ball (White-tipped Scarlet Ball).
 Scarlet Erfurt (Earliest Scarlet Erfurt).
 Scarlet Frame (Dreer's Scarlet Frame).
 Scarlet Globe (Early Scarlet Globe).
 Scarlet Olive (Olive-shaped Scarlet).
 Scarlet Short-top (Long Scarlet Short-top).
 Scarlet Strap-leaved (Long Scarlet Strap-leaved).
 Scarlet Turnip (Early Scarlet Turnip).
 Shepherd.
 Startle.
 Strasburg (White Star Strasburg).
 Sunnet (Gray Sunnet).
 Surprise.
 Three-leaved (Leonard's Three-leaved).
 Twenty-day.
 Vaughan (Vaughan's Market).
 Violet Olive (Violet Olive-shaped White-tipped).
 Violet Turnip (Violet Turnip White-tipped).
 White-Forcing (Round White forcing).
 White Globe (Large White Globe).
 White Olive.

White Naples (Long White Naples).
 White Spanish (Long White Spanish).
 White Summer (White Summer Turnip).
 White-tipped Turnip (White-tipped Scarlet Turnip).
 White Turnip.
 White Vienna (Long White Vienna).
 White Winter (Long White Winter).
 Wood Frame (Wood's Early Frame).
 Yellow Ball (Early Yellow Ball).
 Yellow Olive (Olive-shaped Golden Yellow).
 Yellow Turnip (Early Yellow Turnip).
 1834 (The 1834).
81 varieties.

RAPE—

English, or Spring Sprouts.
 Large-seeded (Large-seeded Garden).
 Winter, or Siberian Sprouts.

RHUBARB—

Linnæus.
 Mammoth.
 Myatt's Victoria.
 Paragon.
 St. Martins.
 Victoria.

6 varieties.

ROQUETTE—*Brassica Eruca.*ROSEMARY—*Rosemarinus officinalis.*SAGE—*Salvia officinalis*—

Common.
 Mammoth.
 Red—*S. Hominum.*

SALSIFY, or OYSTER-PLANT—

Breck (Breck's Improved).
 Long White.
 Sandwich Island (New Sandwich Island Mammoth).
 White French.

SAVOY—*Satureia hortensis*—

Summer.
 Winter—*S. montana.*

- SCORZONERA—
 Long Black.
- SEA-KALE.
- SHALLOT—*Allium ascalonicum*.
- SKIRRET—*Sium Sisarum*.
- SORREL—
 Broad-leaved French.
 Patience Dock (Garden Patience Dock).
 Large-leaved.
- SPINACH—
 Arlington (Arlington Pointed-leaved).
 Bloomsdale.
 Dreer Savoy (Dreer's Round-seeded Savoy).
 Ely Market Garden (Ely's Market Garden).
 Evergreen.
 Flanders (Broad Flanders).
 Ironclad.
 Round-seeded Savoy (Large Round-seeded Savoy).
 Lettuce-leaved.
 Long Standing.
 Market Garden.
 New Zealand Spinach—*Tetragonia expansa*.
 Norfolk (Norfolk Savoy-leaved).
 Prickly.
 Round Dutch (Common Round Dutch).
 Round Leaf.
 Round Summer.
 Thick-leaved.
 Viroflay (Large Round-leaved Viroflay).
19 varieties.
- SQUASH—(Some of these varieties are also catalogued with Pumpkins)—
 Acorn, or Chilian.
 American Turban.
 Arlington Crookneck (Arlington Summer Crookneck).
 Bay State.
 Bergen (Green-striped Bergen).
 Bishop's Head.
 Boston Marrow.
 Brazil Sugar.
 Brazilian.
 Butman.
 Canada Crookneck (Canadian Winter Crookneck).
 Chicago Marrow (Chicago Orange Marrow).
 Chili (Mammoth Chili.)
 Coconut.
 Cushaw (Improved Cushaw).
 Dunlap Marrow.
 Egg (New Egg).
 Egg-plant.
 Essex (Essex Hybrid).
 Gem (Perfect Gem).
 Giant Crookneck (New Giant Summer Crookneck).
 Golden Bush (Early Golden Bush).
 Golden Cluster.
 Golden Crookneck (Golden Summer Crookneck).
 Golden Custard.
 Green Crookneck (Green Summer Crookneck).
 Hubbard.
 Iron Mask.
 Japan, or Yokohama.
 Mammoth.
 Mammoth Bush (New Mammoth White Bush).
 Mammoth Yellow.
 Marblehead.
 Mediterranean.
 Metcalf.
 Olive.
 Orange County (Orange County Mammoth).
 Orange Marrow (Early Orange Prolific Marrow, Early Orange Marrow).
 Patagonian, or Seven Year's Custard.
 Pineapple.
 Prolific Marrow.
 Prolific Sugar (New Prolific Sugar).
 Premium (Premium Hybrid).
 Red China (New Red China).
 Salem Valparaiso (Salem Improved Valparaiso).
 Sibley, or Pike's Peak.
 Summer Crookneck (Bush Summer Crookneck).

SQUASH, *continued*.

Strickler (The Strickler Summer).
 Turban, or Turk's Cap.
 Valparaiso, or Lima Cocoanut.
 Vegetable Marrow.
 White Chestnut.
 White Scallop (White Bush Scallop).
 Winter Crookneck.
 Woodbury.
 Yellow Scallop (Yellow Bush Scallop).

56 varieties.

STACHYS—

Stachys affinis.
S. tuberosa.

STRAWBERRY BLITE, or STRAWBERRY

SPINAGE—*Chenopodium (Blitum) capitatum.*

SCOLYMUS—*Scolymus hispanicus.*

SWEET POTATO—

Bermuda (Red Bermuda).
 Carolina (Extra Early Carolina).
 Golden (Early Golden).
 Grant (General Grant).
 Mammoth Red.
 New Jersey.
 Peabody (Early Peabody).
 Red Jersey.
 Red Nansemond.
 Southern Queen.
 White Queen.
 Yellow Jersey (Improved Yellow Jersey).
 Yellow Nansemond.

13 varieties.

THYME—*Thymus vulgaris.*

English (Broad-leaved English).
 French.

TOMATO—

Acme.
 Advance (Extra Early Advance).
 Alpha.
 Americus (Americus Hybrid).
 Amber Gem.
 Annie Dine.
 Atlantic (Atlantic Prize).
 Autocrat.
 Bay State.
 Beauty (Livingston's Beauty).
 Bermuda (Early Bermuda).

Boston Market.

Brandywine.

Brouze-leaved.

Canada Victor.

Cardinal.

Cincinnati (Cincinnati Purple).

Climax.

Conqueror.

Curled-leaf (Hubbard's Curled-leaf).

Dwarf Champion.

Emery.

Essex (Essex Hybrid).

Farquhar (Farquhar's Faultless).

Favorite (Livingston's Favorite).

Fiji (Fiji Island, or Lester's Perfected).

Fulton Market.

Garfield (President Garfield).

Golden Rod.

Golden Queen.

Golden Trophy.

Grant (General Grant).

Green Gage.

Haines (Haines' No. 64).

Hathaway (Hathaway's Excelsior).

Hovey.

Hundred Day.

Ignotum.

Italy (Wonder of Italy).

Jersey (Early Jersey).

Jones (Jones' Early Hybrid).

Jones Thirty.

Jubilee (Child's Golden Jubilee).

King Humbert.

King (King of the Earlies).

La Crosse (Salzer's La Crosse Seedling).

Large Yellow.

Little Gem.

Lorillard.

Matchless.

Mayflower.

McCullom (McCullom's Hybrid).

Mikado.

Morning Star.

Nesbit (Nesbit's Victoria).

New York Market.

Optimus.

Paragon.

Peach.

TOMATO, *continued.*

Perfection (Livingston's Perfection).
 Potato-leaf.
 Prelude.
 Puritan.
 Queen.
 Red Apple.
 Red Cherry.
 Red Currant.
 Red Pear.
 Ringleader.
 Ruby (Early Ruby).
 Salzer (Salzer's Earliest of All).
 Shah.
 Scoville (Scoville's Hybrid).
 Sunrise (Golden Sunrise).
 Tilden.
 Tom Thumb.
 Tree.
 Trophy.
 Volunteer.
 White Apple (Snowball).
 Yellow Pear.

81 varieties.

TURNIP, FLAT. (*Some of these varieties are probably Ruta-Bagas. See next list.*)
 Bloomsdale (Bloomsdale Red Top).
 Bread Stone.
 Budlong (Budlong Improved White Rock).
 Devonshire (Devonshire Grey Stone).
 Flat Dutch (Early Flat Dutch).
 Golden Ball.
 Golden Stone.
 Green Barrel.
 Hartley (Hartley Prize-top).
 Imperial (Imperial Prize).
 Jersey Navet.
 Large Yellow, or Amber Globe.
 Lily (Carter's Jersey Lily).
 Long White, or Cow Horn.
 Milan (Early Purple-top Milan, Strap Leaved Extra Early Milan).
 Montmagny.
 Morigny (Gray Morigny).
 Munich (Purple-top Munich).

Norfolk (Long White Norfolk).
 Orange Jelly.
 Pearce (Pearce's Invincible).
 Pomeranian (Pomeranian White Globe).
 Purple-top Globe (Purple-top White Globe).
 Purple-top Mammoth.
 Purple-top Strap-leaf (Purple-top White Strap-leaf).
 Red-top Globe (Red-top White Globe).
 Red-top Olive.
 Red-top Strap-leaf.
 Seven Top.
 Shape (Shape's Improved).
 Six Weeks (Early Six Weeks).
 Snowball (Early Snowball).
 Snow Globe (Snow-white Globe).
 Stone (Salzer's Early Stone).
 Teltow, or Small Berlin.
 Vertus (Long White Vertus).
 Waite (Waite's Gem).
 Westbury (Westbury Sweet).
 White Egg.
 White French (Long White French).
 White Globe (Large White Globe).
 White Model.
 White Tankard.
 White Strap-leaf (White Globe Strap-leaved, Early White Strap-leaved).
 Yellow Aberdeen (Purple-top Yellow Aberdeen).
 Yellow Finland.
 Yellow Globe.
 Yellow Malta.
 Yellow Stone (Early Yellow Stone).
 Yellow Tankard.

50 varieties.

TURNIP, RUTA-BAGA—

Ashcrofts.
 Bangholm.
 Champion (Sutton's Champion Swede).
 Golden Globe.
 Golden Swede.
 Green-top.
 Heavy-cropping (Maule's Heavy-cropping Swede).

TURNIP, *continued.*

Harbey.
 Imperial Hardy.
 Improved Purple-top.
 Improved Swede.
 Laing (Laing's Strap-leaved.)
 Large White.
 Long Island (Long Island Improved Purple-top).
 London (London Purple-top Swede).
 Lothian (East Lothian Purple-top Swede).
 Prussian.
 Purple-top, or American.
 Red-top Globe (Large Red-top Globe).
 Sutton's Purple-top (Sutton's Improved Purple-top Swede).
 Swede King (King of the Swedes).
 Sweet German.
 Shamrock (Shamrock Yellow Globe).
 Skirving (Skirving's Purple-top).
 Westbury.
 White-flesh Purple-top.
 White French.
 White Russian.
 White Swede.
 Yellow.
 Yellow French.

31 varieties.

WATERMELON—

African.
 Apple Pie.
 Arkansas (Arkansas Traveler).
 Asia Glory (Glory of Asia).
 Asia Triumph (Triumph of Asia).
 Black Italian.
 Black Spanish.
 Boss.
 California, or Improved Odella.
 Citron.
 Chinese.
 Christmas (Johnson's Christmas, New Christmas).
 Colorado Citron (Colorado Preserving Citron).
 Cuban Queen.

Cream Flesh (Cream Flesh Sculptured-seeded).
 Dark Icing, or Ice Rind.
 Delaware.
 Excelsior.
 Extra Early.
 Faust (Faust's Pride of the Century).
 Florida (Florida Favorite).
 Georgia (Pride of Georgia).
 Gipsy.
 Golden Flesh.
 Golden Honey.
 Green Gold (Green and Gold).
 Hallock Phinney.
 Hoosier (Hoosier King).
 Hungarian (Hungarian Honey).
 Ice Cream.
 Imperial (Goodwin's Imperial).
 Iron Clad (Mammoth Iron Clad).
 Japan Sculptured.
 Jersey Blue.
 Jumbo.
 Kentucky (Kentucky Wonder).
 Kolb (Kolb's Gem).
 Liberian.
 Light Icing.
 Medicinal.
 Monarch (Jordan's Gray Monarch).
 Mountain Sprout.
 Mountain Sweet.
 Oemler (Oemler's Triumph).
 Orange.
 Pearl.
 Peerless.
 Phinney (Phinney's Early).
 Pipe (Early Pipe).
 Scaly Bark.
 Seminole.
 Shipper (Shipper's Favorite).
 Sibley (Sibley's Triumph).
 Stokes (Stokes' Early).
 Striped Gipsy, Jackson, or Rattle-Snake.
 Vick (Vick's Early).
 Volga.
 White Gem.

58 varieties.

3. Plant Portraits of 1889.

A list of all the illustrations in the leading journals which are of such character as to aid in the determination of species and varieties.

ABBREVIATIONS.—*Am. Flor.*, American Florist; *Am. Gar.*, American Garden; *Bot. Mag.*, Botanical Magazine; *Cal. Flor.*, California Florist (now united with Pacific Rural Press); *Cal. Frt. Gr.*, California Fruit Grower; *Can. Hort.*, Canadian Horticulturist; *Gar. & For.*, Garden & Forest; *Gar. Chron.*, Gardeners' Chronicle; *Gar. Mag.*, Gardener's Magazine; *Gar. World*, Gardening World; *Gart.*, Gartenflora; *Hort. Belge*, Revue de l'Horticulture Belge et Etrangère; *Hort. Art Jour.*, Horticultural Art Journal; *Ill. Hort.*, L'Illustration Horticole; *Int. Hort.*, International Horticulturist (now Trade Journal); *Jour. Hort.*, Journal of Horticulture; *Jour. Roses*, Journal des Roses; *Orch. & Gar.*, Orchard & Garden; *Pop. Gar.*, Popular Gardening; *Rev. Hort.*, Revue Horticole; *R. N.-Y.*, Rural New Yorker.

- Abies Albertiana*, Garden, Jan. 26.
 — *bracteata*, *Gar. Chron.*, Feb. 23.
 — *Smithiana*, Garden, June 29.
 — varieties, *Gar. Chron.*, Feb. 9.
Abutilon vitifolium alba, *Gar. Chron.*, Aug. 10; *Pop. Gar.*, Nov.
 — *vexillarium*, *Jour. Hort.*, May 2.
Acacia flexicaulis, *Gar. & For.*, Aug. 21.
Actinidia polygama, *R. N.-Y.*, July 27.
Adiantum Capillus-veneris, Garden, May 11.
 — *cuneatum* *Versaillense*, *Gar. World*, Aug. 10.
 — *Farleyense*, Garden, Dec. 14.
 — *pedatum*, Garden, Feb. 2.
 — *reginæ*, *Gar. Chron.*, Nov. 16.
 — *tetraphyllum*, var. *obtusum*, *Ill. Hort.*, Aug. 10.
 — *Versaillense*, *Hort. Belge*, Oct.
Adonis Pyrenaica, *Gar. World*, April 20.
Æchmea Drakeana, *Rev. Hort.*, Aug. 16.
 — *Mertensii*, *Gart.*, Oct. 1.
Ærides expansum *Seoniæ*, *Gart.*, Apr. 15.
 — *Lawrenciæ*, Garden, May. 25.
Æsculus Sinensis, *Gar. Chron.*, June 8
Agave candelabrum, *Gar. Chron.*, Jan. 19.
 — *dasyliroides*, *Gar. Chron.*, June 29.
Allamanda Hendersoni, Garden, Oct. 5.
Aloe variegata, *Vick's Mag.*, July.
Alyssum saxatile, *Am. Flor.*, Sept. 1.
Amaryllis Finette, *Gart.*, Aug. 15;
Gar. World, May 4.
 — *John Ruskin*, *Gar. Mag.*, April 13.
Amorphophallus campanulatus, *Gar. Chron.*, June 15.
 — *Titanum*, *Gar. Chron.*, June 15, July 6.
Ampelovitis Davidii, *Rev. Hort.*, May 1.
Andromeda Mariana, *Am. Gar.*, Aug.
 — *speciosa*, *Am. Flor.*, Oct. 15.
 — *speciosa cassinefolia*, *Jour. Hort.*, Aug. 1.
Anemone alpina sulphurea, Garden, Jan. 5.
 — *ranunculoides* and *A. thalictroides*, Garden, May 4.
Angræcum Chailluanum, *Jour. Hort.*, Sept. 26.
 — *Germinyanum*, *Bot. Mag.*, t. 7061.
 — *Sanderianum*, *Hort. Belge*, Oct.
Anoiganthus breviflorus, *Bot. Mag.*, t. 7072; *Gar. Chron.*, May 4.
Anthurium Andreanum, *Gart.*, Mar. 1
 — *Andreanum* vars. *atropurpureum* and *Somsæ*, *Hort. Belge*, Aug.

- Anthurium Dechardi, Gart., June 15.
 — Scherzerianum, Gart., June 15.
 — — var. Lucienne Linden, Ill. Hort., Aug. 10.
 — — var. Madame Desmet Duvivier, Ill. Hort., June.
 — — var. Mme. de la Devansaye, Ill. Hort., Oct. 25.
 Antirrhinum, group, Garden, Feb. 2.
 Aphelandra cristata, Jour. Hort., Oct. 3.
 Aponogeton distachyon, Pop. Gar., Feb.
 Apple, Alexander, Hort. Art Jour., Apr.
 — Alfriston or Fibbett's Pearmain, Gar. Mag., Mar. 2.
 — Antonovka, Hort. Art Jour., Jan.
 — Belle de Longue, Rev. Hort., Sept. 1.
 — Blenheim Pippin, Gar. Mag., Aug. 31.
 — Bloomless, Am. Gar., July.
 — King of the Pippins, Gar. Mag., Nov. 9.
 — Duchess of Oldenburg, Gar. Mag., May; Can. Hort., Feb. 23.
 — Dumelow's Seedling, Gar. Mag., Jan. 26.
 — Ecklinville, Gar. Mag., Aug. 24.
 — Jones' Seedling, Hort. Art Jour., Aug.
 — Keeper, Orch. & Gar., Sept.
 — Lord Suffield, Garden, June 15.
 — Martha, Crab, Hort. Art Jour., Dec.
 — Murphy, Orch. & Gar., Mar.
 — Norfolk Beefing, Gar. Mag., Mar. 30.
 — Parson's Sweet, Hort. Art Jour., Nov.
 — Pewaukee, Hort. Art Jour., Oct.
 — Potts' Seedling, Gar. Mag., Oct. 19.
 — Prince Alfred, Jour. Hort., June 20.
 — Princess Louise, Int. Hort., Apr.
 — Queen, Can. Hort., Jan.
 Apple, Rambo, Hort. Art Jour., Jan.
 — Rambom Queen, Hort. Art Jour., July.
 — Shupheld's Seedling, Am. Gar., Dec.
 — Soulard, Am. Gar., Jan.
 — Stone Antonovka, Can. Hort., p. 216.
 — Tetofsky, Hort. Art Jour., Jan.
 — Wealthy, Can. Hort., Nov.; Hort. Art Jour., Mar.
 — Wellington, Garden, May 11.
 — Winter Quoining, Gar. Mag., May 4.
 — Worcester Pearmain, Gar. Mag., Oct. 5.
 Apricot, Russian, Can. Hort., Oct.
 Aquilegia chrysantha grandiflora alba, Vick's Mag., Oct.
 — flabellata, var. Hort. Belge, July.
 Arachnanthe Clarkei, Bot. Mag., t. 7077.
 Aralia Chinensis, Am. Gar., Mar.
 — Sieboldi, Garden, July 13.
 Arctotis acaulis, Garden, Nov. 23.
 Areca lutescens, Am. Flor., July 15.
 Aristolochia elegans, Hort. Belge, Feb.
 — Siphon, Vick's Mag., Mar.
 — hians, Bot. Mag., t. 7073.
 Artichoke, Large Green Paris, Garden, Apr. 6.
 Ash, Weeping, R. N.-Y., Jan. 26.
 Aster Amellus, Garden, Feb. 23.
 — Herveyi, Gar. & For., Oct. 2.
 — linearifolius, Garden, Feb. 23.
 — Lindleyanus, Gar. & For., Sept. 18.
 — Stracheyi, Garden, Mar. 16.
 Astilbe, Japanese, Garden, Nov. 30.
 Athanasia annua, Jour. Hort., Sept. 19.
 Artocarpus integrifolia, Garden, May 18.
 Bakeria Tillandsioides, Rev. Hort., Feb. 16.
 Bambusa aurea, Am. Flor., Sept. 1.
 — Mazelli, Metahe, and mitis, Garden, Nov. 30.

- Barnardesia rosea, Gar. Chron., Mar. 9.
- Bean, Burpee's Bush Lima, R. N. Y., Oct. 19; Int. Hort., Nov. 16.
- Dwarf Lima, Am. Gar., Nov.
- Henderson's Dwarf Lima, R. N.-Y., Oct. 19.
- Kumerle's Dwarf Lima, R. N.-Y., Oct. 19.
- Beaufortia purpurea, Am. Gar., Nov.
- Beech, Purple, Gar. & For., May 8.
- Weeping, R. N.-Y., May 4.
- Beet, Scarlet-ribbed Chilean, Orch. & Gar., Mar.
- Begonia, Cannell's Triumph, Gar. World, Aug. 3.
- Clementinæ, Am. Flor., Oct. 1.
- corallina, Jour. Hort., July 11.
- hybrida gigantea carminata semperflorens, Gart., Aug. 15.
- John Heal, Garden, Mar. 9; Gar. Mag., May 25.
- Lynchiana, Garden, Nov. 9.
- M. Charrat, Am. Flor., Oct. 1.
- metallica, Am. Gar., Feb.
- Mme. Rival, Am. Flor., Oct. 1.
- Mme. Allamagny, Am. Flor., Oct. 1.
- octopetala Lemoinea, Am. Flor., Jan. 1; Garden, Feb. 9; Rev. Hort., Jan. 16; Vick's Mag., Mar.
- peltata var., Ill. Hort., July.
- Rex + diadema, Hort. Belge, Apr.
- Rosebud, double, Gar. World, July 13.
- Scharffiana, Garden, Nov. 9.
- Siebold, Am. Flor., Oct. 1.
- socotrana, Garden, Mar. 9.
- Triomphe de Lemoine, Gar. & For., Nov. 20.
- tubereux, Hort. Belge, Nov.
- Weltoniensis, Garden, Nov. 9.
- Berberis angulosa, Bot. Mag., t. 7071.
- Lycium, Bot. Mag., t. 7075.
- Thunbergii, Gar. & For., Jan. 30.
- vulgaris asperma, Garden, Mar. 23.
- Bertolonia, Madame Alfred Bleu, Rev. Hort., Dec. 16.
- Billbergia thyrsoidea, Gart., Feb. 1.
- vexillaria, Rev. Hort., Oct. 16.
- Windii, hort. Makoy, Gart., Jan. 1.
- Birch, Cut-leaved Weeping, Orch. & Gar., Oct.
- Blackberry, Agawam, R. N.-Y., Aug. 24.
- Bagnard, R. N.-Y., Sept. 14.
- Early King, R. N.-Y., Sept. 14.
- Erie, R. N.-Y., Sept. 14.
- Gaynor, R. N.-Y., Sept. 14.
- Minnewaski, R. N.-Y., Sept. 14.
- Blackberry + Raspberry, R. N.-Y., Nov. 23.
- Boronia heterophylla, Rev. Hort., Jan. 16.
- Bougainvillea glabra, Rev. Hort., June 16.
- Bouvardia vars., Garden, Mar. 30.
- Mrs. H. Green, Garden, Mar. 30.
- President Cleveland, Hort. Belge, Jan.; Garden, Mar. 30.
- Brahea nitida, Garden, Mar. 30.
- Broccoli, Branching, Gar. Chron., June 8.
- Sutton's New Branching, Gar. World, July 20.
- Brodiaea Palmeri, Gar. & For., May 22.
- Brownea macrophylla, Bot. Mag., t. 7033.
- Buddleia auriculata, Gar. Chron., Nov. 9.
- Bulbophyllum lemniscatum, Garden, June 29.
- umbellatum, Jour. Hort., Oct. 24.
- Calandrinia oppositifolia, Vick's Mag., Feb.
- Calanthe vestita grandiflora, Hort. Belge, June.
- Caliandra oppositifolia, Bot. Mag., t. 7051.
- Calochortus flavus, Am. Gar., Oct.
- Madrensis, Am. Gar., Oct.
- Obispøensis, Gar. & For., Apr. 3.

- Calystegia sylvatica*, Garden, Mar. 9.
Camellia, vars., Garden, Jan. 26 ;
 Gar. Chron., Apr. 6.
 — Japanese, Garden, Sept. 14.
Campanula abietina, Jour. Hort.,
 Jan. 31.
 — *Calycanthemus*, Rev. Hort.,
 Dec. 1.
 — *primulæfolia*, Gar. Mag., May 4.
 — *grandiflora pumila*, Jour. Hort.,
 Feb. 14.
Canna, Guillaume Couston, Gart.,
 Aug.
 — *iridiflora Ehemanni*, Garden,
 Mar. 2 ; Orch. & Gar., May.
 — *Madame Crozy*, Rev. Hort.,
 Sept. 16.
 — Louis Thibaut, Gard., Mar. 2.
 — Victor Hugo, Garden, Mar. 2.
Capparis spinosa, Rev. Hort., Jan. 1.
Cardoon, Artichoke-leaved, Garden,
 April 20.
 — Prickly Tours, Garden, Apr. 20.
 — Smooth Solid, Garden, Apr. 20.
Carex variegata, Jour. Hort., Nov.
 14.
Carludovica rotundifolia, Bot. Mag.,
 t. 7083.
Carnation, M. Bergendi, Garden,
 Apr. 13.
 — Mlle. Rousell, Garden, Apr. 13.
 — group, Hort. Art Jour., Jan.
Carpenteria Californica, Int. Hort.,
 May 15 ; Am. Gar., June.
Catalpa bignonioides, Garden, Sept.
 14.
 — hybrid, Gar. & For., June 26.
Catasetum Bungeoethi, Gar. Chron.
 Apr. 13.
 — *Garne'tianum*, Bot. Mag., t.
 7069.
Cattleya Harrisoniæ, Gar. Chron.,
 Jan. 26.
 — *Loddigesii*, Gar. Chron., Jan.
 26.
 — Miss Harris, Jour. Hort., Oct.
 10.
 — *Percivaliana*, Garden, June 8.
 — *Sanderiana*, Jour. Hort., June 6.
 — *Schilleriana*, Gart., Jan. 15.
 — *Skinneri*, Gar. Chron., June 1.
Cattleya Walkeriana, Gart., June 1.
 — *Warscewiczii Hardyana*, Gar.
 World, Aug. 24, p. 82.
Cedar of Lebanon, Gar. & For.,
 Mar. 27.
Celery, Bouquet, Pop. Gar., Dec.
 — Dwarf Golden Self-blanching,
 Vick's Mag., Nov.
Centaurea macrocephala, Jour
 Hort., Sep. 5.
Cephalanthus occidentalis, Am. Gar.,
 July ; Int. Hort., July 15.
Ceratotheca triloba, Gart., Sept. 1.
Cereus Pringlei, Gar. & For., Feb. 6.
Chamærops humilis, var. *dactylo-*
carpa, Bulletino de la R.
 Soc. Tos. di Ort., Mar.
Chironia peduncularis, Bot. Mag.
 t. 7047.
Cherry, Koslov Bush Morello, Can.
 Hort., p. 217.
 — Laurel, Gar. Chron., May 18.
 — Wragg, Hort. Art Jour., Feb.
Chrysanthemum, A d a Spaulding,
 Am. Flor., Aug. 15, Dec. 15.
 — Amy Furze, Gar. World, Oct.
 26.
 — Baron d' Avene, Hort. Belge,
 Feb.
 — Bendigo, Vick's Mag., Nov.
 — Cottage Pink, Garden, Jan. 26.
 — Cullingfordii, Gart., April 1 ;
 Vick's Mag., Nov.
 — D'Automne, Rev. Hort., Jan. 1.
 — Early-flowering Pompon, Gar.
 Mag., Nov. 30.
 — Edwin H. Fidler, Int. Hort.,
 April.
 — Hamlet, Gar. Mag., Nov. 2.
 — Indicum, Gart., Apr. 1.
 — Japanese, Jour. Hort., Oct. 31.
 — Japon. Hort. Belge, Dec.
 — Jeanne Marty, Hort. Belge,
 Feb.
 — Joseph Marvet, Hort. Belge,
 Feb.
 — *lacustre*, Gar. Chron., May 11.
 — *Le Charineuse*, Vick's Mag.,
 Sep.
 — *Leucanthemum semi-duplex*,
 Gar. World, June 1.

- Chrysanthemum*, Macaulay, *Gar. World*, Nov. 9.
 — Madame Desgrange, *Garden*, June 1.
 — maximum, *Gar. World*, June 1; *Gar. Chron.*, May 11.
 — Medusa, *Gar. & For.*, Feb. 27.
 — Miss Mary Anderson, *Jour. Hort.*, Nov. 14.
 — Mons. Roux, *Gar. World*, Nov. 9.
 — Mrs. Alpheus Hardy, *Jour. Hort.*, Nov.; *Pop. Gar.* Feb.; *Garden*, Apr. 6; *Gar. Chron.*, Nov. 9; *Gar. World*, Nov. 30; *Gar. Mag.*, Feb. 23; *Orch. & Gar.*, Jan.
 — Mrs. Carter, *Jour. Hort.*, Nov. 21.
 — Mrs. Goldring, *Vick's Mag.*, Sept.
 — Mrs. H. Hawkins, *Gar. Mag.*, Nov. 30.
 — Mrs. Judge Benedict, *Jour. Hort.*, Nov. 28.
 — Nymphæa, *Am. Gar.*, May.
 — Nympe, *Gar. Chron.*, Nov. 9.
 — Roi des Precoces, *Gar. World*, Nov. 9.
 — Sam Sloan, *Vick's Mag.*, Nov.
 — Single, *Garden*, Apr. 27.
 — Swanley, *Vick's Mag.*, Sept.
 — uliginosum, *Am. Flor.*, June 15; *Vick's Mag.*, July; *Gar. Chron.*, May 25.
 — vars., *Can. Hort.*, Apr.
 — vars., *Gard. Chron.*, Dec. 14.
 — White Venus, *Gart.*, Apr. 1.
 — Wm. H. Lincoln, *Gar. & For.*, Apr. 24.
Cineraria, hybrid, *Rev. Hort.*, Apr. 16.
Cirrhopetalum Cumingi, *Jour. Hort.*, Feb. 14.
Cistus Clusi, *Gar. Mag.*, May 11.
 — Sarcodactylis, *Rev. Hort* Oct. 1.
Citrus sinensis myrtifolia, *Am. Gar.*, Feb.
 — triptera, *Garden*, Apr. 6.
Clarkia pulchella, *Garden*, June 15.
Clematis Madame Furtado-Heine, *Rev. Hort.*, Mar. 1.
Clerodendron fœtidum, *Gar. Mag.*, Aug. 10.
Clethra alnifolia, *Hort. Art Jour.*, Oct.
 — arborea, *Gar. Chron.*, Sept. 28.
Clivia miniata var. Chevalier Hinderick, *Ill. Hort.*, Apr.
 — — var. Lady Wolverton, *Gar. World*, Apr. 6.
Coburgia trichroma, *Garden*, July 13.
Cochliostema Jacobianum, *Garden*, Nov. 23.
Cocos australis, *Gart.*, Sept. 1.
 — nucifera, *Am. Gar.*, July.
 — Weddelliana, *Garden*, Sept. 21.
Cœlogyne cristata, *Am. Flor.*, June 1.
Coleus, seedling, *Am. Gar.*, June.
Colocasia Indica, *Gart.*, Feb. 1.
Comparettia falcata, *Garden*, Aug. 24.
Convallaria majalis, var. prolificans, *Gart.*, Feb. 15.
Cordia Greggii, var. Palmeri, *Gar. & For.*, May 15.
Cornus Spathi, *Jour. Hort.*, Oct. 10.
Cosmos hybridus, *Pop. Gar.*, June.
Cotoneaster horizontalis, *Rev. Hort.*, Aug. 1.
Cratægus tomentosa, *Gar. & For.*, Sept. 4.
Crinum Schimperii, *Abyssinia*, *Gart.*, Nov. 1.
Croton Warreni, *Garden*, Oct. 12.
Cryptomeria Japonica, *Garden*, Sept. 21.
Cucumber, Lockie's Perfection, *Gar.*, *Chron.*, Nov. 23.
 — Rollisson's Telephone, *Garden*, June 8.
Currant, La Versailles, *Am. Gar.*, Sept.
 — Crandall, *Am. Gar.*, Sept.
 — White Grape, *Am. Gar.*, Sept.
 — White, *Garden*, Feb. 9.
Custard-apple, *Am. Gar.*, Dec.
Cyclamen Persicum, *Garden*, Oct. 26.
Cycnoches pentadactylon, *Gar. Chron.*, Aug. 17.

- Cydonia Sinensis*, Rev. Hort., May. 16.
Cymbidium Devonianum, Jour Hort., May 16.
 — *eburneum*, Garden, Apr. 27.
Cyperus alternifolius, Garden, June 15.
Cyphomandra betacea, Pop. Gar. June.
Cypripedium barbatum, var. *Warnerianum*, Ill. Hort., June.
 — *bellatulum*, Jour. Hort., Jan. 17 and June 6; Rev. Hort., May 1.
 — *Curtisi*, Gar. Chron., May 18.
 — *Dauthieri marmoratum*, Hort. Belge, Nov.
 — *Farrieanum*, Jour. Hort., Jan. 17.
 — *Godefroyæ*, var. *Mariæ*, Hort. Belge, May.
 — *grande*, Gar. Mag., Feb. 9.
 — *Lathamianum*, Gart., Oct. 1.
 — *Mæsereelianum* + Ill. Hort., March.
 — *Measuresianum*, Gar. Mag., Jan. 19.
 — *Morgania*, Garden, Nov. 16.
 — *nitens superbum*, Le Moniteur d'Hort., June 10
 — *Pitcherianum*, Gar. Chron., Jan. 19.
 — *picturatum*, Jour. Hort., Oct. 17.
 — *Rothschildianum*, Jour. Hort., Mar. 21.
 — *Sanderianum*, Gar. Mag., Feb. 9.
 — *Spicerianum magnificum*, Gar. World, Dec. 14.
 — *Stonei platytænium*, Jour. Hort., Jan. 31; Am. Gar., May; Gar. World, Jan. 12.
 — *superbiens*, Jour. Hort., Jan. 17.
Cyrilla racemiflora, Am. Gar., Sept.
Daffodil, Ard Righ, Jour. Hort., Mar. 14.
 — varieties, Jour. Hort., Apr. 11; Gar. World, Mar. 2.
 — group of, Gar. Chron., Apr. 13.
Dahlia Barkeriæ, Gar. Mag., Sept. 7.
 — *glabrata*, Gar. Mag., Sept. 7.
 — *lilliput alba plena*, Hort. Belge, Mar.
 — *Paragon*, Gar. World, Jan. 19.
 — *superflua*, Gar. Mag., Sept. 7.
 — varieties, Gar. Chron., Sept. 7.
Daphne Blagayana, Garden, June 8.
 — *Mezereum autumnalis*, Garden, June 29.
Dasyllirion acrotrichum, Garden, Nov. 2.
Datura arborea, Gar. Chron., Jan. 19.
 — *suaveolens*, Garden, Feb. 9.
Delphinium Zalil, Bot. Mag., t. 7049.
Dendrobium bigibbum, Gar. World, Oct. 5.
 — *densiflorum* var. *albo-luteum*, Hort. Belge, Sept.
 — *Falconeri*, Jour. Hort., Nov. 7.
 — *gracilicaule*, Bot. Mag., t. 7042.
 — *nobile*, Am. Flor., Apr. 15; Gar. Chron., May 1.
 — *Pierardi*, Jour. Hort., Apr. 11; Garden, July 1.
 — *polyphlebium*, and var. *Emerici*, Gar. Chron., Aug. 31.
 — *undulatum*, Jour. Hort., Mar. 14.
 — *Wardianum*, Gar. World, Apr. 13.
Dendrocalamus giganteus, Gar. & For., Jan. 9.
Dendrochilum filiforme, Gar. & For., Oct. 9.
Desfontania spinosa, Gar. Mag., Apr. 6.
Dicentra cucullaria, Vick's Mag. Apr.
 — *Canadensis*, Vick's Mag., Apr.
Dicksonia antarctica, Vick's Mag., Dec.; Garden, Aug. 31.
 — *Billardieri*, Gart., Dec. 1.
Dictamnus Fraxinella var. *alba*, Garden, May 18.
Diervilla candida, Am. Gar., Aug.
Dietes Huttoni, Garden, Aug. 24.
Dipladenia amabilis, Garden, April 20.
Disa lacera, var. *multifida*, Bot. Mag., t. 7066.

- Dogwood, Red-flowering, Hort. Art. Jour., Mar.; Can. Hort., Sept.
- Doryopteris palmata, Jour. Hort., Nov. 21.
- Dracæna marmorata, Bot. Mag., t. 7078.
- Drynaria morbillosa, Garden, Sept. 7.
- Echinacea intermedia, Pop. Gar., Sept.
- Echinocactus Bolansis, Gart., Feb. 15.
- Echinopsis cristata, Gart. June.
- Embothrium coccineum, Gar. Mag., June 8.
- Enkianthus campanulatus, Bot. Mag., t. 7059.
- Eomecon chionantha, Garden, Jan. 26.
- Epacris miniata splendens, Garden, Feb. 23.
- Epiphyllum Makoyanum, Jour Hort., May 2; Hort. Belge, Oct.
- Russellianum var. Gærtneri, Hort. Belge, Oct.
- Eremostachys laciniata, Bot. Mag., t. 7048.
- Eremurus Himalaicus, Bot. Mag., t. 7076.
- spectabilis, Gar. Mag., June 8.
- Erica ardentissima, Hort. Belge., April.
- hyacinthiflora candidissima, Hort. Belge, April.
- hyacinthiflora fulgens, Hort. Belge, April.
- intermedia, Garden, Feb. 2.
- McNabiana, Jour. Hort., Jan. 24.
- princes, Jour. Hort., Jan. 10.
- propendens, Jour. Hort., Jan. 10.
- rubella, Hort. Belge, April.
- Sunset, Hort. Belge, April.
- ventricosa coccinea minor Garden, March 2.
- Wilmoreana, Am. Flor., Jan. 15; Garden, Feb. 2.
- Erythrophlœum pubistamineum, Gart., Jan. 15.
- Eucalyptus Staigeriana, Gar. Chron., Mar. 9.
- stricta, Bot. Mag., t. 7074.
- Eucharis Lehmanni, Gart., June 15.
- Eucryphia pinnatifolia, Bot. Mag., t. 7067.
- Eugenia Michellii, Rev. Hort., Nov. 16.
- Eugenia Garberi, Gar. & For., Jan. 16.
- Eulophia megistophylla, Garden, Jan. 19.
- Exacum macranthum, Jour. Hort., June 6; Gar. Mag., June 15.
- Fendlera rupicola, Gar. & For., Mar. 6.
- Fern, New Australian Tree, Cal. Flor., Jan.
- Ficus elastica, Gar & For., Nov. 13.
- Parcelli, Orch. & Gar., Aug.
- Fittonia argyroneura, Garden, Dec. 7.
- Fraxinus Greggii, Gar. & For., Sept. 18.
- Freesia refracta alba, Gart., July 1.
- Fritillaria Bucharica, Bot. Mag., t. 7080.
- imperialis folium aureum, Vick's Mag., June.
- Kantschatcensis, Garden, Feb. 16.
- Forsythia viridissima, Rev. Hort., Apr. 16.
- suspensa, Rev. Hort., April 16.
- Foxglove, Garden, March 30.
- Fuchsia, Berlinerkind, Vick's Mag., Jan.
- procumbens, Pop. Gar., July.
- splendens, Jour. Hort., Feb. 28.
- triphylla, Gar. World, Feb. 16; Hort. Belge., Dec.
- Funkia Sieboldi, Garden, May 18.
- undulata, var., Hort. Art Jour., Aug.
- Galaopsis dubia, Jour. Hort., Feb. 21.
- Garrya elliptica fœmina, Jour. Hort., June 13.
- Gerbera Jamesoni, Bot. Mag., t. 7087; Garden, Oct. 12; Gar. Chron., June 22.

- Gigantochloa atter, Gar. & For., Jan. 9.
- Gilliflower, Quarantaine d'ete Victoria, Rev. Hort., Feb. 16.
- Ginkgo adiantifolia, Gar. Chron., Mar. 2.
- Gladiolus, Early, Jour. Hort., May 30.
- Hybrid, Gar. Chron., Sept. 28.
- Colvillei, The Bride, Gart., July 1.
- Dwarf California, Am. Gar., Oct.; Int. Hort., Oct. 15.
- Hyde's White, Am. Gar., Dec.
- purpureo-auratus, Gar. & For., Feb. 20.
- Gleichenia dicarpa longipinnata, Gar. World, Dec. 21.
- Gloxinia maculata, Garden, Nov. 2.
- varieties, Ill. Hort., Aug. 31.
- Godetia, Fairy Queen, Gar. Chron., Jan. 5.
- Reine des Fees, Hort. Belge, Nov.
- Gooseberry, Golden Prolific, Pop. Gar., May; Orch. & Gar., April; Vick's Mag., April.
- Pearl, Can. Hort., p. 318.
- Gordonia anomala, Garden, Nov. 2.
- Gourds, Gar. Chron., Dec. 14.
- Grape, Diamond, Vick's Mag., April.
- Eaton, R. N.-Y., Sept. 28.
- Geneva, R. N.-Y., Jan. 26.
- Green Mountain, Hort. Art Jour., Feb.; Orch. & Gar., Nov.
- Keystone, Int. Hort., June 15.
- Moyer, Pop. Gar., Jan.
- Niagara, R. N.-Y., Jan. 12.
- Vergennes, Can. Hort., Feb.
- White Muscat, Cal. Flor., Jan.
- Grevillea asplenifolia, Bot. Mag., t. 7070.
- robusta, Am. Flor., Apr. 15; Garden, May 18.
- Grewia parvidora, Gart., Nov. 15.
- Griffinia hyacinthina, Garden, Oct. 26.
- Gymnocladus dioicus, Gar. & For., Feb. 13.
- Gymnogramme elegantissima, Gar. Mag., May 18; Hort. Belge, Sept.
- schizophylla, Gar. & For., Nov. 6.
- Hedera dentata, Garden, June 6.
- glomerulata, Gar. Mag., June 22.
- Helianthemum tuberaria, Gar. Mag., June 15.
- Helianthus mollis, var. cordatus, Gar. & For., Mar. 20.
- Hellebores, Garden, April 6.
- Helleborus niger, St. Brigid, Am. Flor., April 15.
- Hibiscus trionum, Garden, Jan. 12.
- Hickory, Shell-bark, Gar. & For., Sept. 25.
- Hippeastrum reticulatum, Gart. May 1.
- Hollyhock, Garden, Aug. 17.
- Mrs. Sharman, Gar. Mag. Mar. 16.
- Pompon Rose, Gar. Mag. Mar. 30.
- Princess Beatrice, Gar. Mag., Feb. 2.
- Shirley Hibberd, Gar. Mag., Feb. 2.
- varieties, Gar. Chron., July 20.
- Holmskioldia sanguinea, Jour. Hort., Sept. 12.
- Honeysuckle, Can. Hort., July.
- Hoya bella, Jour. Hort., July 18.
- Humulus Japonicus, Gar. World, Jan. 12.
- Hyacinthus azureus, Garden, Aug. 10.
- Hypericum aureum, Gar. & For., April 17.
- Moserianum, Rev. Hort., Oct. 16.
- Ilex Amelanchier, Gar. & For., Jan. 23.
- Illicium Floridanum, Garden, Aug. 17.
- Imantophyllum, Am. Flor., Oct. 15.
- miniatum, Vick's Mag., June.
- Impatiens Rodigasi, Ill. Hort., Mar.
- Iris alata, Garden, Nov. 16.

- Iris Bakeriana*, Bot. Mag., t. 7084.
 — *Barnumæ*, Bot. Mag., t. 7050.
 — *German*, Vick's Mag., Mar.
 — *Japanese*, Jour. Hort., Jan. 24 ;
 Orch. & Gar., Dec.
 — *nuda*, Bot. Mag., t. 7040.
 — *Rosenbachiana*, Jour. Hort.,
 Mar. 21.
 — *Tingitana*, Garden, Sept. 28.
Ixianthes retzioides, Gar. Chron.,
 Feb. 2.
Jasminum nudicaule, Gar. Chron.,
 Feb. 23.
Juglans Sieboldiana, Orch. & Gar.,
 April.
Jujube, Cal. Frt. Gr., Dec. 7.
 — var. *inermis*, Orch. & Gar.,
 April.
Juniperus recurva, Garden, Sept. 7.
Kalanchoe carnea, Am. Flor., Mar.
 1 ; Jour. Hort., Jan. 10.
Kentia Canterburyana, Garden,
 Apr. 6.
 — *Forsteriana*, Garden, Apr. 6 ;
 Am. Flor., July 15.
Keteleeria Fortunei, Garden, Feb. 23.
Kniphophia aloides, var. *glauces-*
cens, Garden, Nov. 16.
Kunzea pomifera, Am. Gar., Apr. ;
 Int. Hort., Nov. 15.
Lachenalia Nelsoni, Gart., Mar. 15.
 — *luteola*, Gart., Mar. 15.
 — *pendula*, Gart., Mar. 15.
Lælia albida, Garden, Apr. 6.
 — *Digbyana Mossiæ*, Jour. Hort.,
 May 23 ; Gar. Chron., May
 25 ; Gar. World, May 25 ; Int.
 Hort., Aug. 15 ; Am. Gar.,
 Sept.
 — *præstans alba*, Jour. Hort.,
 Oct. 17.
Laportea moroides, Bot. Mag., t.
 7057.
Larch, Weeping, Garden, Mar. 16.
Latania Borbanica, Am. Flor., July
 15.
Lathræa clandestina, Gar. Chron.,
 May 25.
Leucæna pulverulenta, Gar. & For.,
 Aug. 14.
Licuala Veitchii, Bot. Mag., t. 7053.
Lily, Snake's Head, Jour. Hort.,
 April 25.
Lilium auratum, Garden, Sept. 28 ;
 Hort. Belge, June.
 — *Batemannia*, Gar. Mag., Aug.
 17.
 — *Bolanderi*, Jour. Hort., Aug. 1.
 — *Browni*, Gar. Mag., Jan. 26.
 — *longiflorum*, Gar. Mag., Mar.
 23.
 — *elegans atrosanguineum*, Vick's
 Mag., May.
 — — *Alice Wilson*, Gar. Mag.
 Apr. 27.
 — — *Van Houttei*, Gar. Mag.,
 May 25.
 — *giganteum*, Jour. Hort., Mar. 7.
 — *Japonicum*, Gar. Mag., July 13.
 — — *odorum*, Gar. Mag.
 Mar. 2.
 — *martagon*, var. *atrosanguin-*
eum, Bulletino della R. Soc
 Toscana di Orticultura, Feb.
 — *Nepalense*, Garden, Jan. 19 ;
 Bot. Mag., t. 7043.
 — *pardalinum*, Gar. Mag., Aug. 24.
 — *Parryi*, Gar. Mag., Apr. 13.
 — *parvum*, Jour. Hort., July 25.
 — *speciosum*, Garden, Nov. 9.
 — *Washingtonianum purpureum*,
 Gar. Mag., Sept. 14.
Linaria Macedonica, Jour. Hort.,
 June 27.
Lindsæa Lessoni, Garden, Jan. 12.
 — *trichomanoides*, Garden, Jan.
 12.
Liquidambar Styraciflua, Gar. &
 For., May 15.
Lobelia laxiflora, Gart., July 1.
Lonicera fragrantissima, Gar. Chron.,
 Feb. 23.
 — *sempervirens*, Jour. Hort.,
 Aug. 1.
 — *Standishii*, Gar. Chron., Feb.
 23.
Lourya campanulata, Rev. Hort.,
 Mar. 16.
Luculia gratissima, Bul. de la R. Soc.
 Tos. di Ort., Apr. ; Garden,
 Jan. 19.

- Luculia Pinceana*, Garden, Jan. 19.
Lupinus subcarnosus, Am. Gar., Dec.
Lycaste Skinneri delicatissima, Hort. Belge., April.
Lychnis Haageana, Garden, June 1.
Macleania punctata, Gar. Chron., Apr. 27.
Macodes Javanica, Bot. Mag. t. 7037.
Magnolia conspicua, Jour. Hort., Jan. 17.
Mamillaria elephantidens, Gar Mag., Mar. 16.
— *Grusoni*, Gart., Feb. 15.
— *macromeris*, Gar. Mag., Mar. 16.
— *pectinata*, Gar. Mag., Mar. 16.
— *viviparia radiosa*, Gar. Mag., Mar. 16.
Maple, Japanese, Orch. & Gar., Dec.
— Purple, Hort. Art Jour., Nov.
Masdevallias, Gar. Chron., Nov. 30; Gar. Mag., Nov. 16.
— *chimæra*, Gart., Dec. 1.
Megasea Stracheyi, Garden, Sept. 28.
Mignonette, Hybrid Spiral, Gar World, Sept. 21.
Miltonia Phalænopsis, Garden, Mar. 23.
— *spectabilis*, Hort. Belge, Feb.
— *vexillaria*, Garden, Mar. 23.
Mimulus Emperor, Am. Gar., Feb.; Int. Hort., Apr.
Mina lobata, Garden, Sept. 21.
Mistletoe, Jour. Hort., Jan. 31.
Mormodes luxatum, Rev. Hort. Mar. 16.
Mutisia Clematis, Garden, July 27; Gar. Chron., Apr. 20; Jour. Hort., Mar. 28.
Myosotidium nobile, Garden, Dec. 14.
Narcissus bicolor, Empress, Jour. Hort., May 9.
— — *grandis*, Jour Hort., May 9.
— — *Horsefieldi*, Jour. Hort., May 9.
— *juncifolia* × *muticus*, Gar. Chron., Aug. 10.
Narcissus muticus, Gar. World, May 18.
— Paper White, Garden, Mar. 23.
— *Tazetta*, Gar. Chron., Apr. 13.
— *variiformis*, Jour. Hort., Apr. 18.
Neillia Torreyi, Gar. & For., Jan. 2.
Nelumbium speciosum, Gar. & For., Apr. 10.
Nepenthes Burkeii, Gar. Chron., Nov. 2.
— *Curtisi*, Gar. Chron., Dec. 7.
— *Dicksoniana*, Gart., Sept. 1; Gar. World, Sept. 14.
Nephrolepis rufescens tripinnatifida, Hort. Belge, Oct.
Nouelia insignis, Rev. Hort., May 16.
Nymphæa Devoniensis, Orch. & Gar., June.
Oak, Burr, Gar. & For., Oct. 16.
Odontoglossum Brandtii, Gart., Oct. 15.
— *elegans*, Gar. World., Apr. 13.
— *Cervantesi* var. *decorum*, Ill. Hort., Oct. 25.
— *crispum*, var. *Bickleyense*, Gar. World, Jan. 19.
— — var. *leopardinum*, Gar. World, Jan. 19.
— — var. *President Zhaldua*, Ill. Hort., Apr.
— — var. *Ruckerianum superbum*, Rev. Hort., Feb. 1.
— *luteo-purpureum*, var. *crispatum*, Gar. Chron., Feb. 23.
— *Marriottianum* (?), Gar. World, June 22.
— *Pescatorei*, Gar. Chron., Dec. 14; Jour. Hort., Feb. 21; Am. Flor., Dec. 1.
Olearia Gunniana, Gar. World, Aug. 17.
— *insignis*, Bot. Mag., t. 7034.
— *macrodonta*, Bot. Mag., t. 7065.
Oncidium crispum grandiflorum, Jour. Hort., July 18.
— *Cræsus*, Garden, June 22.
— *Jonesianum*, Hort. Belge, Jan.
Onopordon Arabicum, Garden, May 4
Opuntia polycantha, Bot. Mag., t. 7046.

- Opuntia Rafinesquii*, Bot. Mag., t. 7041.
Ostrowskya magnifica, Pop. Gar., Jan.: Am. Flor., Mar. 1.
Oxera pulchella, Ill. Hort., Feb.
Oxylobium callistachys, Jour. Hort., June 27.
Pæonia officinalis lobata, Jour. Hort., June 6.
— Whitleyi, Garden, July 6.
Palm, Date, Am. Gar., Aug.
Pandanus utilis, Am. Flor., July 15.
— Veitchii, Am. Flor., July 15.
Pandulus labyrinthicus, Bot. Mag., t. 7063.
Pansy, Ariel, Garden, Nov. 2.
Papaver lævigatum, Gar. Chron., Jan, 5.
— nudicaule alba, Gar. World, Mar. 23.
— orientale, Gar. World, Mar. 9; Vick's Mag., Feb.
Passiflora, Eynsford Gem, Gar. Chron., Apr. 20; Vick's Mag., Aug.
— Hahnii, Bot. Mag., t. 7052.
— triloba, Ill. Hort., July.
— Watsoniana, Ill. Hort., Jan.
Pear, Dwarf Shell, Gar. Mag., Nov. 30.
— King of the Dwarfs, Vick's Mag., Sept.
Peach, Champion, Hort. Art Jour., Dec.
— Dwarf Japan Blood, Am. Gar., July.
— Domergue, Rev. Hort., Apr. 1.
— Early Rivers, Hort. Art Jour., May.
— Lovett's White, Orch. & Gar., Aug.
— Mignonette, Am. Gar., May; Garden, Mar. 16; Int. Hort., Sept. 15.
— Red Ceylon, Int. Hort., July 15.
— Reine des tardives, Rev. Hort., July 16.
— Wonderful, Pop. Gar., Apr.
Pear, Beurre d'Amanlis, Garden, June 1.
Pear, Beurre de L'Assomption, Gar. World, Oct. 12.
— — Diel, Jour. Hort., June 13.
— Duchess, Can. Hort., Jan.
— Eyewood, Gar. Mag., Oct. 11.
— Hessle, Gar. Mag., Oct. 11.
— Idaho, Can. Hort., Jan.
— Jargonelle, Garden, Jan. 19; Gar. Mag., Nov.
— Lawson, Orch. & Gar., Feb.
— Lincoln, R. N.-Y., Nov. 16.
— Nec Plus Meuris, Gar. Mag., Nov. 23.
— Pres. Drouard, Hort. Art Jour., Nov.
— Seckel, Hort. Art Jour., Mar.; Gar. Mag., Oct. 5.
— Vermont Beauty, Hort. Art Jour., Sept.
— Wilder Early, Orch. & Gar., Oct.; Pop. Gar., Nov.
Pelargonium, H. Cannell, Jr., Vick's Mag., July.
— album multiflorum, Garden, Feb. 16.
— Regal and Decorative, Gar. World, May 11.
— The Bridesmaid, Vick's Mag., Oct.
— zonale Lilliput, President Auguste Van Geert, Hort. Belge, Apr.
Pentstemon rotundifolius, Bot. Mag., t. 7055.
— varieties, Gar. World, Aug. 3.
Pepper, Ornamental, Orch. & Gar., Feb.
— varieties, Rev. Hort., Nov. 1.
Persea gratissima, Ill. Hort., Feb.
Persimmon, Japanese, Hort. Art Jour., April, July.
Phalænopsis amabilis, Garden, Apr. 20.
— gloriosa, Garden, Apr. 20.
— Mariæ, Jour. Hort., Mar. 14.
— Schilleriana, Garden, Apr. 20.
Phajus pauciflorus, Bot. Mag., t. 7086.
Philadelphus microphyllus, Gar. Mag., Aug. 31.

- Phillyrea Vilmoriniana, Rev. Hort., May 1.
 Phlox, varieties, Am. Gar., Jan.
 — Drummondi, varieties, Gar. World, Jan. 5.
 Phœnix Rœbelenii, Gar. Chron., Oct. 26.
 — reclinata, Am. Flor., July 15.
 — rupicola, Am. Flor., July 15.
 Phormium tenax Veitchianum, Am. Flor., Sept. 1.
 Phyllocactus delicatus, Garden, Sept. 21.
 Physosiphon Loddigesi, Jour. Hort., Aug. 29.
 Phytolacca dioica, Gar. Chron., Aug. 24.
 Picea Alcockiana, Gart., Apr. 15.
 — Ajanensis, Gart., Aug. 15.
 — bracteata, Garden, Jan. 5.
 — excelsa var. viminalis, Gart., Mar. 1.
 — lasiocarpa, Garden, Mar. 2.
 — Webbiana, Garden, Feb. 9.
 Pineapple, Egyptian Queen, Am. Gar., Feb.
 — Smooth-leaved Cayenne, Am. Gar., Feb.
 Pinus insignis, Garden, July 20.
 — Jeffreyi, Gar. Chron., Mar. 23.
 — latifolia, Gar. & For., Oct. 16.
 — Mugho, Vick's Mag., Sept.
 — Prince Grisebach, Gart., July 1.
 — Sabiniana, Gar. Chron., Jan. 12.
 Platanus occidentalis, Gar. & For., July 24.
 Plum, Early Green, Can. Hort., p. 265.
 — Fellemburg, Hort. Art Jour., Dec.
 — Kelsey, Garden, Feb. 16.
 — Simon's, Can. Hort., June.
 — Wayland, Am. Gar., May; R. N.-Y., Mar. 16.
 Plumiera bicolor, Gart., Mar. 1.
 Podophyllum pleianthum, Gar. Chron., Sept. 14.
 Polemonium pauciflorum, Gar. Chron., July 27.
 — Richardsoni, Gar. World, July 27.
 Poppy, Anemone, Gar. World, June 15.
 Portlandia pterosperma, Gar. & For., May 1.
 Potato, Bliss' Rough Diamond, Am. Gar., Jan.
 — Brownell's Winner, R. N.-Y., Feb. 16.
 — Pasteur, Rev. Hort., Feb. 1.
 Primrose, College, Garden, Aug. 31.
 — Double Crimson Velvet, Gar. World, Mar. 16.
 — Jack-in-the-Green, Gar. World, April 27.
 Primula denticulata, Garden, June 8.
 — floribunda, Gar. World, Mar. 16.
 — Palinuri Petagna, Gart., Nov. 15.
 — petiolaris, Bot. Mag., t. 7079, B.
 — pusila, Bot. Mag., t. 7079, A.
 — Sieboldii, Garden, Oct. 5.
 — Sinensis alba plena grandiflora, Hort. Belge, Mar.
 Primulina tabacum, Gar. Chron., Sept. 28.
 Promenœa Rollissoni, Garden, July 20.
 Prunus pendula, Gar. & For., Oct. 9.
 — Pissardi, Hort. Art Jour., Feb.; Pop. Garden., Dec.
 — Simoni, Can. Hort., June.
 — tomentosa, Vick's Mag., Nov.
 — triloba, Garden, June 29.
 Psoralea pinnata, Gar. Chron. June 1.
 Pteris Cretica, Garden, Oct. 19.
 — — nobilis, Gar. Chron., Nov. 16.
 — serrulata compacta, Gar. World, Nov. 23.
 Pyrus Malus floribunda, Gar. & For., Oct. 30.
 Quince, Japan, Vick's Mag., Jan.; Pop. Gar., Jan.
 Rafflesia Arnoldi, Am. Gar., Feb.
 Ranunculus aconitifolius flore pleno, Garden, June 22.
 Raspberry, Hornet, Jour. Hort., July 18.
 — Thompson's Early Prolific, Int. Hort., May 15.

- Raspberry, Shaffer, Can. Hort., Aug.
Remijia pedunculata, Garden, Apr. 13.
Rheum officinale, Garden, Sept. 14.
Rhipsalis pulvinigera, Gart., Apr. 1.
Rhododendron arborescens, Gart.,
 Jan. 15.
 — *balsaminæflorum album*, Gar.
 World, Feb. 9.
 — *campanulatum*, Garden, May 4.
 — Countess of Haddington, Gar-
 den, April 13.
 — Her Majesty, Gar. World,
 June 15.
 — Hybrid, Jour. Hort., Oct. 31.
 — *Keysi*, Garden, May 4.
 — *Nilagiricum*, Garden, July 20.
 — *Nobleanum*, Garden, March 2.
 — *retusum*, Gar. Mag., Oct. 12.
 — *Veitchi*, Garden, March 16.
Rhus typhina, Gar. & For., July 17.
Romneya Coulteri, Jour. Hort.
 Feb. 7.
Rosa alba forma *suaveolens*, Gart.,
 Mar. 1.
 — *berberidifolia*, Gar. Chron.
 July 6 and 20.
 — *Engelmanni*, Gar. & For., Aug.
 7.
 — *Gallica* var. *Damascena* forma
trigintipetala, Gart., Mar. 1.
 — *gigantea*, Gar. Chron., July 6.
 — *humilis* var. *triloba*, Gar. &
 For., Feb. 13.
 — *incarnata*, Bot. Mag., t. 7035.
 — *lævigata*, Gar. Chron., Nov. 2.
 — *polyantha*, Am. Gar., June.
 — *rugosa*, Am. Flor., Dec. 1.
 — — hybrids, R. N.-Y., Oct.
 12.
 Rose, Bonstetten, Can. Hort., Mar.
 — *Bride*, Vick's Mag., June.
 — *Catherine Mermet*, Vick's
 Mag., June.
 — *Climbing Niphetos*, Vick's
 Mag., June.
 — *Clotilde Soupert*, Jour. Roses,
 Mar.
 — *Comte Adrien de Germiny*, Jour.
 Roses, May.
 — *Comtesse de Nadaillac*, Gar-
 den, Oct. 19.
Rose, Duchess de Dino, Rev. Hort.,
 Nov. 16.
 — *Eclair*, Jour. Roses, Apr.
 — *Francesco Ingegnoli*, Jour.
 Roses, June.
 — *Francois Michelon*, R. N.-Y.,
 Jan. 19.
 — *Glory of Rosamond*, Am. Gar.,
 Sept.
 — *Gustave Piganeau*, Jour. Roses,
 Oct.
 — *Harrison's Yellow* × *Rosa ru-*
gosa, Am. Gar., June.
 — *Innocente Pirola*, Garden,
 Nov. 30.
 — *Jean Pernet*, Garden, Dec. 14.
 — *John Hopper*, Hort. Art Jour.,
 June; Can. Hort., Dec.
 — *Joseph Bernacchi*, Jour. Roses,
 Aug.
 — *La Marque*, R. N.-Y., Nov. 9.
 — *La Reine*, Hort. Art Jour.,
 June.
 — *Mad. Plantier*, Hort. Art Jour.,
 Aug.
 — *Mademoiselle Jeanne Guillau-*
mez, Jour. Roses, Nov.
 — *Magna Charta*, Am. Gar., June.
 — *Marquis de Vivens*, Garden,
 Feb. 16.
 — *Maman Cochet*, Jour. Roses,
 Sept.
 — *Mlle. Blanche Rebatel*, Jour.
 Roses, Feb.
 — *Oscar II*, Rio de Suede, Jour.
 Roses, Dec.
 — *Papa Gontier*, Vick's Mag.
 June.
 — *Paul's Single White*, Jour.
 Hort., June 20.
 — *Rainbow*, Cal. Flor., Feb.
 — *Rubens*, Gar. Chron., Aug. 10.
 — *Salet*, Hort. Art Jour., Sept.
 — *Scipion Cochet*, Jour. Roses,
 Jan.
 — *Souvenir du Rosieriste Gonod*,
 Jour. Roses, Aug.
 — *White Moss*, Hort. Art Jour.,
 Mar., May.
Rudbeckia laciniata, Gar. & For.,
 June 12.

- Rubus fruticosus pomponius*, or *albus plenus*, Pop. Gar., Feb.
Ruellia macrantha, Gar. World, Jan. 26.
Saccolabium bellinum, Garden, May. 11.
 — *Blumei majus*, Garden, Sept. 7.
 — *cœleste*, Jour. Hort., Mar. 7.
Salpichroma rhomboideum, Garden, April 20.
Salvia splendens, var. *Bruanti*, Gar. Chron. Dec. 7.
Sarcochilus luniferus, Bot. Mag., t. 7044.
Sarcodes sanguinea, Am. Gar., Jan.
Sarracenia Wrigleyana, Gar. Mag., May 25; Gar. World, Aug. 31; Gart., Sept. 15.
Satyrium aurantiacum, Jour. Hort., Oct. 3.
Saxifraga Aizoon, Gar. World, Apr. 6.
 — *Camposi*, Am. Flor., June 1; Garden, Apr. 27.
 — *cuscutiformis*, Gar. Chron., Mar. 16.
 — *media*, Gar. Chron., Mar. 16.
 — *latepetiolata*, Bot. Mag. t. 7056.
 — *longifolia*, Garden, Oct. 5.
 — *Malyi*, Jour. Hort., May 9.
 — *Maweana*, Gar. Chron., Mar. 16.
 — *Burseriana*, var. *major*, Gar. Chron., Mar. 16.
 — *pyrenaica*, var. *superba*, Gar. Chron., Mar. 16.
 — *ciliata*, Gar. Chron., Mar. 23.
 — *sarmentosa tricolor superba*, Hort. Belge, May.
 — *varieties*, Am. Gar., July.
Scabiosa Caucasica, Garden, Feb. 9.
Scilla Ledieni, Gart., Mar. 15.
Scutellaria alpina, Rev. Hort., Jan. 1.
Sea-kale, Jour. Hort., May 16.
Senecio Petasites, Gar. Chron. July 13.
Shortia galacifolia, Gar. Chron., Mar. 30; Jour. Hort., Apr. 4.
Simaruba Tulæ, Gart., May 15.
Skimmia Fortunei, Gar. Chron. Apr. 27.
Skimmia Foremani, Gar. Chron., May 4
 — *fragrans*, Gar. Chron., Apr. 27; Garden, May 25.
 — *Japonica*, Gar. Chron., Apr. 27; Garden, May 25.
 — *oblata*, Gar. Chron., Apr. 27.
Smilax aspera, Garden, Nov. 23.
 — *officinalis*, Bot. Mag., t. 7054.
Sobralia leucoxantha, Bot. Mag., t. 7058.
 — *xantholeuca*, Gar. Chron., Jan. 5
Solanum albidum Poortmani, Garden, Jan. 26.
 — *pensile*, Bot. Mag., t. 7062.
Spathoglottis ixioides, Bot. Mag., t. 7060.
Spiræa Fortunei paniculata, Garden, July 27.
 — *millefolium*, Gar. & For., Oct. 23.
 — *prunifolia*, Vick's Mag., April.
 — *Van Houttei*, Gar. & For., July 3.
Spruce, Oriental, R. N.-Y., Feb. 16.
Stachys tuberifera, Vick's Mag., Mar.
Stanhopea tigrina, Gar. Mag., July 6.
Stapelia, Hort. Belge, Sept.
 — *gigantea*, Bot. Mag., t. 7068.
Staphylea Bolanderi, Gar. & For., Nov. 13.
Stemmatium narcissoides, Gart. July 15.
Stipa pennata, Orch. & Gar., April.
Strawberry, Burt, Am. Gar., July.
 — *Edgar Queen*, Hort. Art Jour., Oct.
 — *Eureka*, Am. Farm & Hort., Apr.
 — *Haverland*, Am. Farm & Hort., July; Int. Hort., May 15.
 — *Hoffman's Seedling*, Int. Hort., May 15.
 — *Latest of All*, Jour. Hort., July 11; Gar. World, July 13.
 — *Long John*, Pop. Gar., Sept.
 — *Mary*, R. N.-Y., Aug. 10.
 — *New Dominion*, Pop. Gar., Sept.
 — *Noble*, Gar. World, July 13.
 — *Parker Earle*, Am. Gar., Aug.; Hort. Art Jour.; R. N.-Y. July 20.

- Strawberry, Yale, Hort. Art Jour., Sept.
 Strelitzia Nicolai, Bot. Mag., t. 7038.
 — reginæ, Hort. Belge, Feb.
 Streptocarpus parvifolia, Bot. Mag., t. 7036.
 Stuartia pseudo-Camellia, Bot. Mag., t. 7045.
 Styrax Obassia, Bot. Mag., t. 7039.
 Squash, Japanese Winter, Pop. Gar., June.
 — New Japanese, R. N.-Y., Feb. 27.
 Sunset Plant, R. N.-Y., Aug. 3.
 Susum Anthelminticum, Rev. Hort., Feb. 16.
 Syringa Amurensis, Gar. & For., June 5.
 — Japonica, Gar. & For., June 19.
 — villosa, Bot. Mag., t. 7064.
 Tachiadenus carinatus, Gar. Chron., Jan. 12.
 Taxus baccata adpressa, Garden, Jan. 12.
 — — Dovastoni, Garden, Jan. 12.
 — — fructu-luteo, Garden, Jan. 12.
 — — Hibernica, Garden, Jan. 12.
 — — variegata aurea, Garden, Jan. 12.
 Tecophilæa cyanocrocus, Gart. July 1.
 Thermopsis barbata, Gar. Mag., July 13.
 Thunbergia affinis, Gar. Mag., May 18
 Tigridia buccifera, Gar. & For. Aug. 28.
 — New, Am. Gar., Dec.
 — Pringlei, Gart., June 15.
 Tilia platyphyllos, Gar. & For., May 29.
 — ulmifolia, Gar. & For., May 29.
 — vulgaris, Gar. & For., May 29.
 Tillandsia Geissei, Gart., July 15.
 — Kirchhoffiana, Gart., Feb. 15.
 — streptophylla, Gart., June 1.
 — tessellata, Rev. Hort., Dec. 16.
 Tomato, Advance, Jour. Hort., July 25.
 Tomato, Gilbert's Surpasse, Garden, Feb. 2.
 — Lorillard, Am. Gar., Mar.
 — Peach, Hort. Art Jour., Dec.
 — Yellow Plum or Green Gage, Garden, Feb. 2.
 Torreya Californica, Gar. Chron., June 29.
 Tournefortia cordifolia, Garden, Mar. 9.
 Trachelospermum Thunbergii, Gar. & For., July 31.
 Tricyrtis hirta, Vick's Mag., July.
 Trillium grandiflorum, Garden, Oct. 26.
 Tritoma caulescens, Gar. Chron., Nov. 16; Garden, April 27.
 Tulipa Batalini, Gart., Oct. 1.
 — Dammanni, Gart., June 15.
 — Maximowiczii, Gart., Oct. 1.
 — vitellina, Garden, Dec. 7.
 Tulips, Hative Grand Duc de Russie, Hort. Belge, Mar.
 Turnip, Long White Meaux, Garden, Oct. 12.
 Uniola Palmeri, Gar. & For., Aug. 21.
 Vaccinium hirsutum, Gar. & For., July 31.
 — stamineum, Am. Flor., Aug. 1.
 Vallota purpurea magnifica, Garden, Mar. 9.
 Vanda Amesiana, Jour. Hort., Feb. 7.
 — Kimballiana, Gar. Chron., Sept. 21.
 Veronica Fairfieldensis, Gar. World, July 6.
 Viburnum lantanoides, Gar. & For., Nov. 6.
 — plicatum, Hort. Art Jour., Feb.
 — Sieboldii, Gar. & For., Nov. 20.
 Vinca rosea, Garden, Nov. 16.
 Vitis palmata, Gar. & For., July 17.
 Vriesia Alberti, Rev. Hort., July 1.
 — hybrida Versaliensis, Ill. Hort., Aug. 31.
 — Magnisiana +, Gart., July 1.
 — Mariæ, Rev. Hort., July 1.
 Waldsteinia trifolia, Garden, Aug. 3.
 Watermelon, White Gem, Hort. Art Jour., Dec.

- Watsonia iridifolia, var. O'Brieni,
 Jour. Hort., Sept. 26.
 — rosea, Jour. Hort., Sept. 12.
 Wellingtonia gigantea pendula, Rev.
 Hort., Dec. 1.
 Wrightia Zeylanica, Jour. Hort.,
 May 23.
 Xeronema Moorei, Gart., Aug. 1.
 Xylobium leontoglossum, Bot. Mag.,
 t. 7085.
 Yucca angustifolia, Gar. & For.,
 May 22.
- Yucca baccata, Garden, June 22.
 — filamentosa, Orch. & Gar.,
 June.
 — Treculeana, Garden, June 22.
 — Whipplei, Garden, June 15.
 Zinnia, Lilliput, Rev. Hort., June
 1; Vick's Mag., Dec.
 Zizania aquatica, Gart., May 15.
 Zygopetalum cochleare, Jour. Hort.,
 April 25.
 — crinitum, Hort. Belge, July.

CHAPTER VIII.

DIRECTORIES.

*1. Directory of the National, State, Provincial and
other Most Important Horticultural Societies
in North America.*

Alabama Horticultural Society :

Pres., Geo. I. Motz, Huntsville.
Sec., Frank Boykin, Seale.

American Association of Nurserymen :

Pres., Geo. A. Sweet, Dansville, N. Y.
Sec., Chas. A. Green, Rochester, N. Y.

American Cranberry Growers' Association :

Pres., J. H. Brakeley, Bordentown, N. J.
Sec., A. J. Rider, Trenton, N. J.

American Forestry Congress :

Pres., Jas. A. Beaver, Harrisburg, Pa.
Sec., C. C. Birmey, Philadelphia, Pa.

American Horticultural Society :

Pres., Parker Earle, Cobden, Ill.
Sec., W. H. Ragan, Greencastle, Ind.

American Pomological Society :

Pres., P. J. Berckmans, Augusta, Ga.
Sec., A. A. Crozier, Ann Arbor, Mich.

American Seed Trade Association :

Pres., H. W. Johnson, Philadelphia.
Sec. and Treas., A. M. McCullough, Cincinnati

Arizona Fruit Growers' Association :

Pres., Dr. A. J. Chandler.
Sec., H. R. Patrick, Phoenix.

Arkansas Horticultural Society :

Pres., E. F. Babcock, Little Rock.
 Sec., S. H. Nowlin, Little Rock.

Association of American Cemetery Superintendents :

Pres., Chas. Nichols, Newark, N. J.
 Sec., A. H. Sargent, Akron, O.

British Columbia Fruit Growers' Association :

Pres., J. M. Browning, Vancouver.
 Sec., A. H. B. MacGowan, Vancouver.

California Board of Horticulture :

Pres., Elwood Cooper, Santa Barbara.
 Sec., B. M. Lelong, San Francisco.

California Fruit Association :*

Pres., James A. Webster, Vacaville.
 Sec., F. A. Buckingham, Vacaville.

California Horticultural Society :

Pres., W. C. Blackwood, Haywards,
 Sec., E. J. Wickson, Berkeley.

California State Floral Society :

Pres., E. J. Wickson, Berkeley.
 Sec., Emory E. Smith.

California Viticultural Commission :

Pres., Arpas Haraszthy, San Francisco.
 Sec., Clarence J. Whetmore, San Francisco.

Colorado Horticultural Society :

Pres., C. S. Fanrot, Boulder.
 Sec., Alexander Shaw, Denver.

Connecticut. No State Society.

Delaware. No State Society.

Eastern Nurserymen's Association.

Pres., W. C. Barry, Rochester, N. Y.
 Sec., William Pitkin, Rochester, N. Y.

Florida Fruit Exchange :

Pres., Geo. R. Fairbanks, Jacksonville.
 Sec., A. H. Manville, Jacksonville.

Florida Horticultural Society :

Pres., Dudley W. Adams, Tangierine.
 Sec., E. O. Painter, De Land.

Florida Orange Growers' Union :

Pres., J. C. McKibben, Pomona.
 Sec., J. Russell Kennedy, Palatka

Foreign Fruit Exchange :

Pres., D. Wegman, New York City.
 Sec., F. S. Robinson, New York City.

Georgia Horticultural Society :

Pres., P. J. Berckmans, Augusta.
Sec., T. L. Kinsey, Savannah.

Illinois Horticultural Society :

Pres., H. M. Dunlap, Savoy.
Sec., A. C. Hammond, Warsaw.

Indiana Horticultural Society :

Pres., Joseph Ratcliffe, Richmond.
Sec., C. M. Hobbs, Bridgeport.

Inter-State Shippers' Association :

Pres., A. M. DuBois, Cobden, Ill.
Sec., Thomas Buckle, Villa Ridge, Ill.

Iowa Horticultural Society : ●

Pres., C. G. Patten, Charles City.
Sec., Geo. Van Houton, Lenox.

Kansas Horticultural Society :

Pres., L. Houk, Hutchinson.
Sec., G. C. Brackett, Lawrence.

Kentucky Horticultural Society :

Pres., A. P. Farnsley, Louisville.
Sec., John C. Hawes, Louisville.

Louisiana. No State Society.

Maine Pomological Society :

Pres., Chas. S. Pope, Manchester.
Sec., D. H. Knowlton, Farmington.

Massachusetts Horticultural Society :

Pres., William H. Spooner, Jamaica Plain.
Sec., Robert Manning, Boston.

Michigan Horticultural Society :

Pres., T. T. Lyon, South Haven.
Sec., Edwy C. Reid, Allegan.

Minnesota Horticultural Society :

Pres., Wyman Elliott, Minneapolis.
Sec., S. D. Hillman, Minneapolis.

Mississippi Horticultural Society :

Pres., H. E. McKay, Madison Station.
Sec., J. A. Terry, Crystal Springs.

Missouri Horticultural Society :

Pres., J. C. Evans, Harlem.
Sec., L. A. Goodman, Westport.

Montana. No Society.

Montreal Horticultural Society :

Pres., D. P. Penhallow, Montreal.
Sec., W. W. Dunlop, Montreal.

- National Chrysanthemum Society of America :
 Pres., John Thorpe, Pearl River, N. Y.
 Sec., Edwin Lonsdale, Chestnut Hill, Philadelphia.
- Nebraska Horticultural Society :
 Pres., Samuel Barnard, Table Rock.
 Sec., J. T. Allen, Omaha.
- Nevada. No Society.
- New Hampshire. No Society.
- New Jersey Horticultural Society :
 Pres., Ralph Egge, Hopewell.
 Sec., E. Williams, Montclair.
- New Mexico Horticultural Society :
 Pres., Arthur Boyle, Santa Fe.
 Sec., Geo. H. Cross, Santa Fe.
- New York Horticultural Society. Non-active.
- North Carolina Horticultural Society :
 Pres., J. Van Lindley, Pomona.
 Sec., S. Otho Wilson, Raleigh.
- North Dakota. No Society.
- Northwestern Cider and Vinegar Makers' Association :
 Pres., G. W. Hilliard, Brighton, Ill.
 Sec., L. R. Bryant, Princeton, Ill.
- Nova Scotia Fruit Growers' Society :
 Pres., Henry Chipman, Grand Pré.
 Sec., C. R. H. Starr, Wolfville.
- Ohio Horticultural Society :
 Pres., H. G. Tryon, Willoughby.
 Sec., Geo. W. Campbell, Delaware.
- Ohio and Mississippi Valley Horticultural Society :
 Pres., Thomas Buckle, Villa Ridge, Ill.
 Sec., A. M. DuBois, Cobden, Ill.
- Ontario Fruit Growers' Association :
 Pres., A. McD. Allan, Goodrich.
 Sec., L. Woolverton, Grimsby.
- Oregon Horticultural Society :
 Pres., J. R. Cardwell, Portland.
 Sec., S. A. Clarke, Salem.
- Oregon State Board of Horticulture :
 Pres., J. R. Cardwell, Portland.
 Sec., Ethan W. Allen, Portland.
- Peninsular Horticultural Society :
 Pres., J. W. Kerr, Denton, Md.
 Sec., Wesley Webb, Dover, Del.

- Pennsylvania Horticultural Association :
Pres., H. C. Snavely, Lebanon.
Sec., E. B. Engle, Waynesboro'.
- Pennsylvania Horticultural Society :
Pres., G. W. Childs, Philadelphia.
Sec., D. D. L. Farson, Philadelphia.
- Rhode Island Horticultural Society :
Pres., Amasa M. Eaton, Providence.
Sec., Chas. W. Smith, Providence.
- Society of American Florists :
Pres., J. M. Jordan, St. Louis, Mo.
Sec., W. J. Stewart, St., Boston, Mass.
- South Carolina Horticultural Society :
Pres., H. B. Buist, Greenville.
Sec., G. Wanner, Walhalla.
- South Dakota Horticultural Society :
Pres., G. H. Whitney, Esmond.
Sec., C. A. Keffer, Brookings.
- Tennessee. No Society.
- Texas Horticultural Society :
Pres., W. G. Veal, Fort Worth.
Sec., T. L. Brunk, College Station.
- Texas State Nurserymen's Association :
Pres., E. W. Kirkpatrick, McKinney.
Sec., J. M. Howell, Dallas.
- Utah. No Society.
- Vermont. No Society.
- Virginia Pomological Society. Non-active.
- Washington Horticultural Society :
Pres., Henry Bucy, Tacoma.
Sec., A. N. Miller, Puyallup.
- West Virginia. No Society.
- Western New York Horticultural Society :
Pres., P. Barry, Rochester.
Sec., John Hall, Rochester.
- West Tennessee Horticultural Society :
Pres., J. C. Tharp, Gibson.
Sec., A. A. Cawdery, Gadsden.
- Wisconsin Horticultural Society :
Pres., J. M. Smith, Green Bay.
Sec., B. S. Hoxie, Evansville
- Wyoming. No Society.

2. *List of Horticulturists, or Horticulturists and Botanists, of Experiment Stations in North America.*

Alabama :

P. H. Mell, M. E., Ph. D., Auburn, Botanist and Meteorologist.
Geo. F. Atkinson, Ph. D. Auburn, Biologist.

Arkansas :

E. S. Richman, B. S., Fayetteville, Horticulturist.

California :

E. J. Wickson, A. M., Berkeley, Supt. of Grounds.

Canada (Agricultural Society) :

I. Hoyes Panton, Guelph, Botanist.

Canada (Central Experimental Farm) :

John Craig, Ottawa, Horticulturist.

Colorado :

C. S. Crandall, M. S., Fort Collins, Botanist and Horticulturist.

Delaware :

M. H. Brockwith, Newark, Horticulturist and Entomologist.

Florida :

James C. Neal, Ph. C., M. D., Lake City, Botanist and Entomologist.

Georgia :

Gustave Speth, Griffin, Horticulturist.

Illinois :

Thomas J. Burrill, Ph. D., Champaign, Horticulturist and Botanist.

Indiana :

James Troop, M. S., LaFayette, Horticulturist.

Iowa :

J. L. Budd, M. H., Ames, Horticulturist.

Maine :

F. L. Harvey, M. S., Orono, Botanist and Entomologist.

Maryland :

William H. Bishop, B. S., Agricultural College P. O., Horticulturist.

Kansas :

Edward A. Popenoe, A. M., Manhattan, Horticulturist.

Kentucky :

James Murray, Lexington, Botanist.

Massachusetts (Hatch Station) :

Samuel T. Maynard, B. S., Amherst, Horticulturist.

Michigan :

L. R. Taft, M. S., Agricultural College, P. O., Horticulturist.

- Minnesota :
Samuel B. Green, B. S., St. Anthony Park, Horticulturist.
- Mississippi :
B. W. Saffold, B. S., Agricultural College, P. O., Horticulturist.
- Missouri :
J. W. Clark, B. S., Columbia, Horticulturist and Entomologist.
- Nebraska :
Charles E. Bessey, Ph. D., Lincoln, Director and Botanist.
- Nevada :
W. S. Devol, B. Ag., Reno, Agriculturist and Horticulturist.
- New Jersey :
Byron D. Halsted, Sc. D., New Brunswick, Botanist and Horticulturist.
- New York (Cornell) :
L. H. Bailey, M. S., Ithaca, Horticulturist.
- New York (State) :
C. E. Hunn, Geneva, Acting Horticulturist.
George W. Churchill, Geneva, Acting Pomologist.
- North Carolina :
Gerald McCarthy, B. S., Raleigh, Botanist.
- Ohio :
William J. Green, Columbus, Horticulturist.
- Oregon :
E. R. Lake, M. S., Corvallis, Botanist and Horticulturist.
- Pennsylvania :
George C. Butz, M. S., State College, Centre Co., Horticulturist.
- Rhode Island :
L. F. Kinney, B. S., Kingston, Horticulturist.
- South Carolina :
E. A. Smyth, Jr., A. B., Columbia, Botanist and Entomologist.
- South Dakota :
Charles A. Keffer, Brookings, Supt. Forestry and Horticultural Experiments.
- Tennessee :
F. Lamson Scribner, B. S., Knoxville, Botanist and Horticulturist.
- Texas :
T. L. Brunk, B. S., College Station, Horticulturist.
- Vermont :
B. W. Minott, B. S., Burlington, Horticulturist.
- Virginia :
W. B. Alwood, Blacksburg, Botanist and Entomologist.
- Wisconsin :
Emmett S. Goff, Madison, Horticulturist.

3. *The Botanic Gardens of the World (Penhallow; with recent corrections).*

ALGERIA—I.

Algiers, Jardin d'Acclimatation du Hamma, Charles Rivière, Director.

AUSTRALIA—4.

Adelaide (South Australia), Dr. R. Schomburgk, Director.

Brisbane (Queensland).

Melbourne (Victoria).

Sydney (New South Wales), Charles Moore, F. L. S., Director.

AUSTRO-HUNGARY—13.

Budapest (Transylvania), University Botanic Garden, Dr. L. Juranyi, Director.

Czernowitz (Bukovia), University Botanic Garden, Dr. Ed. Tangl, Dir.

Gratz (Styria), University Botanic Garden, Dr. Leitgeb, Director.

Innsbruck (Tyrol), University Botanic Garden, Dr. Joh. Peyritsch, Dir.

Klagenfurt (Carinthia), Bon. de Jabornegg-Gamsenegg, Director.

Kolozsvár (Transylvania), Royal Botanic Garden, Dr. Aug. Kanitz, Dir.

Krakau (Galicia), University Botanic Garden, Dr. Jos. Thom. de Rostafinski, Director.

Lemberg (Galicia), University Botanic Garden, Dr. Th. Ciesielski, Dir.

Prague (Bohemia), University Botanic Garden, Dr. M. Willkomm, Dir.

Selmeebanya (Transylvania), Prof. A. Fekete, Director.

Trieste (Istria), Raimondo Fominz, Director.

Vienna, University Botanic Garden, Dr. A. J. Kerner, Director.

Vienna, Imperial Horticultural Gardens of Hofburg, Fr. Antoine, Dir.

BELGIUM—5.

Antwerp, Dr. H. Van Heurck, Director.

Brussels, Royal Botanic Gardens, François Crépin, Director.

Ghent, University Botanic Garden, Dr. J. J. Kickx, Director.

Gembloux, Botanic Garden of the Agricultural Institute, Dr. C. Malaise Director.

Liege, University Botanic Garden.

BRAZIL—I.

Rio de Janeiro, Botanic Gardens of the Agricultural Institute, at Corrigez, Dr. Nicolau J. Moreira, Director.

CANADA—I.

Montreal (P. Q.), McGill University Botanic Garden, Prof. D. P. Penhallow, Director.

CANARY ISLANDS—I.

Orotava (Teneriffe), Jardin d'Acclimatation, Mr. Wildpret, Chief Gardener.

CAPE OF GOOD HOPE—3.

Cape Town, Prof. MacOwan, Director.

Graaf Reinet, J. C. Smith, Chief of the Garden.

Graham's Town, Edward Tidmarsh, Chief of the Garden.

CEYLON—I.

Peradenia, Royal Botanic Garden, Dr. Henry Trimen, Director.

CHILI—I.

Santiago, Prof. Fred. Philippi (fils), Director.

CHINA—I.

Hong Kong, C. Ford, Superintendent.

COCHIN CHINA—I.

Saigon, Colonial Botanic Garden, Dr. L. Pierre, Director.

DENMARK—2.

Copenhagen, University Botanic Gardens, Prof. Eug. Warming, Dir.

Copenhagen, Royal Gardens of Rosenberg, Tyge Rothe, Director.

ECUADOR—I.

Quito, Prof. R. P. Al. Sodiro, Director.

EGYPT—I.

Cairo, Gastinel-Bey, Director.

FRANCE—20.

Angers, Dr. Em. Lieutaud, Director.

Besancon, F. Paillot, Director.

Caen, Otto Lignier, Director.

Cannes, Comte d'Emprémesnil, Director.

Clermont-Ferrand.

Dijon, Dr. Laguesse, Director.

Hyeres, Emile Davrillon, Director.

Lille, T. Meurein, Director.

Lyon, Dr. Ant. Magnin, Director.

Montpellier, Prof. J. E. Planchon, Director.

Nancy, Prof. G. Le Monnier, Director.

Nantes, Dr. Ecorchard, Director.

Orleans, M. Rossignol, Director.

Paris, Gardens of the National-History Museum, Prof. Maxime Cornu, Director.

Rochefort, Dr. Barallier, Director.

Rouen, Emm. Blanche, Director.

St. Quentin, Charles Magnier, Director.

Toulon, J. B. Chabaud, Chief Gardener.

Toulouse, Dr. Dominique Clos, Director.

Tours, Prof. David Barnsby, Director.

GERMANY—34.

Aix-la-Chapelle, Dr. M. Debey, Director.

Bamberg (Bavaria), Dr. Funk, Director.

Berlin, Berlin Botanic Gardens, Dr. A. W. Eichler, Director.

Berlin, University Botanic Gardens, Dr. S. Schwendener, Director.

Bonn (Rhenish Prussia), University Botanic Gardens, Dr. Ed. Strasburger, Director.

Breslau (Silesia), Dr. H. R. Göppert, Director.

Brunswick (Brunswick), Botanic Garden of the Polytechnic School, Dr. W. Blasius, Director.

Carlsruhe (Baden), J. Pfister, Director.

Cologne (Rhenish Prussia), Prof. J. Niepraschk, Director.

GERMANY, continued.

- Darmstadt* (Hesse), Dr. Leopold Dippel, Director.
Dresden (Saxony), Dr. Oscar Drude, Director.
Erlangen (Bavaria), Dr. Max. Rees, Director.
Frankfort-on-Main (Hesse-Nassau), Dr. H. Th. Geyler, Director.
Fribourg (Baden), Dr. F. Hildebrand, Director.
Giessen (Hesse), Dr. H. Hoffmann, Director.
Goerlitz (Silesia), Dr. R. Peck, Director.
Greifswald (Pomerania), Dr. Fr. Schmitz, Director.
Halle-upon-Salle (Saxony), Dr. Greg. Kraus, Director.
Hamburg.
Heidelberg (Baden), Dr. E. Pfitzer, Director.
Jenu (Saxe-Cobourg), Dr. E. Stahl, Director.
Kiel (Schleswig-Holstein), Dr. Ad. Engler, Director.
Konigsberg, Dr. Robert Caspary, Director.
Leipzig (Saxony), Dr. Schenck, Director.
Marbourg (Hesse-Nassau), Dr. A. Wigand, Director.
Munden (Hanover), Dr. N. J. C. Muller, Director.
Munich (Bavaria), Dr. C. G. Von Naegeli, Director.
Munster (Westphalia), Dr. O. Brefeld, Director.
Potsdam, Dr. Juhlke, Director.
Rostock (Mecklenburg), Dr. Jean Roeper, Director.
Strasburg (Alsace-Lorraine), Comte Herm. de Solms-Laubach, Director.
Tharand (Saxony), Dr. Fred. Nobbe, Director.
Tubingen (Wurtemberg), Dr. W. Pfeffer, Director.
Wurzberg (Bavaria), Dr. Jul. von Sachs, Director.

GREAT BRITAIN AND IRELAND—12.

- Birmingham* (England), Mr. Latham, Director.
Cambridge (England).
London (England), Chelsea Botanic Gardens, Thos. Moore, Curator.
London (England), Royal Botanic Gardens, Kew, Prof. W. T. T. Dyer, Director.
London (England), Royal Botanic Gardens, Regent's Park, W. Coomber, Superintendent.
London (England), Royal Horticultural Society Gardens, South Kensington, A. F. Barron, Superintendent.
Manchester (England), Bruce Findlay, Curator.
Oxford (England).
Dublin (Ireland), Royal Botanic Gardens, of Glasnevin, Dr. Moore, Dir.
Belfast (Ireland), Royal Belfast Botanic Gardens, R. Motherell, Sec'y.
Edinburgh (Scotland), Royal Botanic Gardens, I. B. Balfour, Director.
Glasgow (Scotland), R. Bullen, Curator.

GREECE—I.

- Athens*, Dr. T. de Heldreich, Director.

GUATEMALA—I.

- Guatemala*, Dr. Francesco Abella, Director.

GUIANA—I.

- Georgetown*, G. S. Jenman, Superintendent.

HOLLAND—4.

- Amsterdam*, Prof. C. A. J. A. Oudemans, Director.
Groningen, Prof. P. De Boer, Director.
Leyden, Dr. W. F. R. Suringar, Director.
Utrecht, Dr. N. W. P. Rauwenhoff, Director.

INDIAN EMPIRE—7.

- Bangalore* (Madras), Col. W. L. Johnson, Director.
Bombay, A. Shuttleworth, Director.
Calcutta, Royal Botanic Gardens, Prof. G. King, Director.
Ganish Kind (Poona), G. W. Woodrow, Director.
Ootacamud, Mr. Jamieson, Director.
Pondichery.
Saharanpur (Bengal), J. F. Duthie, Director.

ITALY—23.

- Bologne*.
Cagliari, Dr. P. Gennari, Director.
Caserta, Dr. N. Terracciano, Director.
Catania, Prof. Fr. Tornabene, Director.
Ferrara, Dr. Carus Massalongo, Director.
Florence, Prof. T. Caruel, Director.
Genoa, Prof. Fred. Delpino, Director.
Lucca, Dr. C. Bicchi, Director.
Messina, Prof. A. Borzi, Director.
Milan, Prof. Fr. Ardissoni, Director.
Modina, Dr. A. Mori, Director.
Naples, Dr. J. A. Pasquale, Director.
Padova, Cav. Dr. P. A. Saccardo, Director.
Palermo, Dr. Aug. Todaro, Director.
Parma, Prof. J. Passerini, Director.
Pavia, Prof. J. Briosi, Director.
Perouse, Prof. Al. Bruschi, Director.
Pisa, Dr. J. Arcangeli, Director.
Portici, Dr. Horace Comes, Director.
Rome, Dr. R. Pirrotta, Director.
Siena, Prof. Att. Tassi, Director.
Turin, Prof. G. Gibelli, Director.
Venice, Sen. Ruchinger, Director.

JAPAN—2.

- Tokio*, Koiskekowa Botanic Gardens, Prof. K. Ito, Director.
Sapporo, Government Botanic Gardens, Dr. K. Miyabe, Director.

JAVA—I.

- Buitenzorg*, Dr. M. Treub, Director.

MALTA—I.

- La Valette*, Dr. Gavino Gulia, Director.

MAURITUS—I.

- Port Louis*, J. Horne, Director.

NATAL—I.

- D'Urban*, Mr. Keit, Superintendent.

NEW ZEALAND—I.

Christchurch, J. B. Armstrong, Director.

PERU—I.

Lima, Dr. Mig. de los Rios, Director.

PHILIPPINE ISLANDS—I.

Manilla (Luzon), Seb. Vidal y Soler, Director.

PORTUGAL—3.

Coimbra, Dr. J. A. Hienriques, Director.

Lisbon, Prof. J. de Andrade Corvo, Director.

Oporto, Dr. F. de S. G. Cardoso, Director.

REUNION, Island of—I.

St. Denis, M. Richard, Director.

ROUMANIA—2.

Bucharest, Dr. Brandza, Director.

Yassy, Dr. A. Fêtu, Director.

RUSSIA—I6.

Dorpat (Livonia), Dr. Ed. Russow, Director.

Helsingfors (Finland), Dr. S. O. Lindberg, Director.

Kazan (Kazan), Prof. N. W. Sorokin, Director.

Kharkoff, Dr. Ad. Pitra, Director.

Kiev, Dr. J. Schmalhausen, Director.

Moscow, Dr. J. Goroschankin, Director.

Nikita (Crimea), Mr. Basarow, Director.

Odessa, Dr. L. Reinhard, Director.

Orel, P. G. Tretjakoff, Director.

Ouman (Kiev), Prof. L. Scrobichewski, Director.

Penza (Penza).

St. Petersburg, Imperial Botanic Gardens, Dr. Ed. de Regel, Director.

St. Petersburg, University Botanic Gardens, Prof. André Bikitoff, Director.

Tiflis, Prof. W. Scharrer, Director.

Woronesh, Dr. J. E. Fischer, Director.

Warsaw, Dr. A. F. de Waldheim, Director.

SCANDINAVIA—7.

Christiania (Norway), Dr. F. C. Schubeler, Director.

Goteborg (Sweden), Hort. Soc. Bot. Gardens, Prof. C. Löwegren, Director.

Lund (Sweden), Dr. F. W. C. Areschong, Director.

Stockholm (Sweden), Gardens of the Royal Academy of Agriculture, E. Lindgren, Superintendent.

Stockholm (Sweden), Royal Gardens of Haga, Prof. M. A. Werner, Director.

Stockholm (Sweden), Swedish Society of Horticultural and Botanical Gardens, M. A. Pital, Director.

Upsala (Sweden), Dr. Th. M. Fries, Director.

SERVIA—I.

Belgrade, Dr. Jos. Pancic, Director.

SIBERIA—I.

Tomsk, Mr. Schestakoff, Director.

SPAIN—2.

Madrid, Dr. Miguel Colmeiro, Director.

Valencia, Dr. José Arévalo Boca, Director.

STRAITS SETTLEMENTS—I.

Singapore, J. Cantley, Director.

SWITZERLAND—3.

Basle, Dr. H. Vöchting, Director.

Berne, Dr. L. Fischer, Director.

Zurich.

TASMANIA—I.

Hobart Town, Mr. Abbot, Director.

UNITED STATES—5:

Brookline (Mass.), Arnold Arboretum of Harvard College, Prof. C. S. Sargent, Director.

Cambridge (Mass.), Harvard College Botanic Gardens, Dr. G. L. Goodale, Director.

Lansing (Michigan), Botanic Garden of State Agricultural College, Dr. W. J. Beal, Director.

St. Louis (Missouri), Missouri Botanic Gardens, Dr. Wm. Trelease, Director.

Washington (D. C.), U. S. Dept. of Agriculture Gardens, Wm. Saunders, Superintendent.

WEST INDIES—6.

Castleton (Jamaica), Wm. Fawcett, Director.

Havana (Cuba), J. Lachaume, Director.

King's House (Jamaica), Wm. Harris, Superintendent.

Kingston, W. R. Elliot, Director.

Port of Spain (Trinidad), H. Prestoe, Director.

St. Pierre (Martinique), Colonial Botanic Gardens, M. Thierry, Director.

4. *Some American Seedsmen and Nurserymen.*

A list of those whose catalogues have come to the editor's table during the year. From these catalogues was compiled the list of vegetables in § 2 of Chapter VII.

Alexander, O. H., Charlotte, Vermont; cereals, potatoes and small fruits.
Aneer Brothers, Rockford, Illinois; seeds.

Anderson, H. S., Union Springs, N. Y.; fruit and ornamental trees.

Arnold, Geo. B., Benton Centre, N. Y.; fruit and ornamental trees.

Babcock, D. W., Dansville, N. Y.; grape vines, small fruits, fruit trees, etc.

Baker Albert, and Pelton, C. B., Lake Helen, Volusia county, Fla.

Benz, Albert, Douglaston, N. Y.; pansies.

- Berckmans, P. J., Augusta, Ga.; fruit and ornamental trees.
- Berger, H. H., San Francisco, Cal.; fruits, trees, shrubs and plants, largely Japanese.
- Blanc, A., Philadelphia, Pa.; cacti.
- Bloomington Nursery, Bloomington, Illinois; trees, plants, shrubs, roses, bulbs, etc.
- Bonnell, Geo. A., Waterloo, Seneca county, N. Y.; potatoes and garden seeds.
- Brackenridge & Co., Govanstown, Baltimore county, Md.; orchids.
- Bragg, B. L. & Co., Springfield, Mass.; vegetable seeds.
- Brandt, D., Bremen, Ohio; small fruits, roses and fruit trees.
- Breck, Joseph & Sons, Boston, Mass.; farm, garden and lawn seeds.
- Bridgeman, Alfred, New York, N. Y.; vegetable, grass and flower seeds.
- Buckbee, H. W., Rockford, Ill.; vegetable seeds and plants.
- Burpee, W. A. & Co., Philadelphia, Pa.; vegetable and flower seeds.
- Champlin, A. E., Oakland, Orange county, Fla.; trees, vines and plants.
- Chase, R. G. & Co., Geneva, N. Y.; ornamental trees, flower and vegetable seeds.
- Childs, John Lewis, Floral Park, Queens county, N. Y.; ornamental trees, flower and vegetable seeds.
- Cleveland Nursery Co., Lakewood, Ohio; small fruits.
- Cole & Brothers, Pella, Iowa; garden, farm and flower seeds.
- Collins, John S., Moorestown, Burlington county, N. J.; small fruits, fruit and ornamental trees.
- Cornish, W. H., Newburgh, N. Y.; garden and flower seeds.
- Crawford, M., Cuyahoga Falls, Ohio; strawberries.
- Culinary Grape Co., Troy, Ohio; White's Northern Muscat grape.
- Currie Brothers, Milwaukee, Wis.; seeds.
- Curtis, F. D., Kirby Homestead, Charlton, N. Y.; apple trees.
- Daniel, J. A., Glen St. Mary, Fla.; fruit trees.
- Davenport, T. C., Philadelphia, Pa.; seed potatoes.
- De Veer, J. A., New York; miscellaneous bulbs, seeds, plants, etc.
- Delano, W. S., Lee Park, Nebraska; field and garden seeds.
- Dingee & Conard Co., West Grove, Chester county, Pa.; roses, hardy plants, bulbs and seeds.
- Douglas, R. & Sons, Waukegan, Illinois; forest, evergreen and ornamental trees.
- Dreer, Henry A., Philadelphia, Pa.; flower and vegetable seeds.
- Duncan Bros., Clear Water Harbor, Hillsborough Co., Fla.; citrus fruits.
- Eager, F. S. & Co., Newburgh, N. Y.; field, flower and garden seeds.
- Ellwanger & Barry, Rochester, N. Y.; fruit and ornamental plants.
- Ely, Z. De Forest & Co., Philadelphia, Pa.; garden seeds.
- Eustis Nurseries, G. H. Morton, prop., Eustis, Fla.; fruit trees.
- Everitt, J. A. & Co., Indianapolis, Ind.; garden and flower seeds.
- Farmer, L. J., Pulaski, N. Y.; berry plants.
- Faust, I. V., Philadelphia, Pa.; garden, field and flower seeds.
- Faxon, M. B., Boston, Mass.; vegetable and flower seeds.
- Ferry, D. M. & Co., Detroit, Mich.; bulbs and seeds for fall planting.
- Ford, Frank & Sons, Ravenna, Ohio; seeds, small fruit plants and trees.
- Gardiner, John & Co., Philadelphia, Pa.; vegetable, flower and farm seeds.
- Giddings & Read, Rutland, Vt.; farm, garden and flower seeds.

- Gillett Bros., South Lake Weir, Marion county, Fla.; fruit trees.
 Gillette, Edward, Southwick, Mass.; North American wild flowers.
 Green, Charles A., Rochester, N. Y.; general nursery supplies.
 Gregory, James J. H., Marblehead, Mass.; seeds—vegetable, flower and grain.
 Hale, J. H. & G. H., South Glastonbury, Conn.; small fruit plants.
 Hales, H. W., Ridgewood, N. J.; flower seeds.
 Hall, J. W., Marion Station, Somerset county, Md.; nursery supplies and seed potatoes.
 Halliday, Robert J., Baltimore, Md.; garden supplies.
 Hallock, V. H. & Son, Queens, N. Y.; flower and vegetable seeds.
 Harkett's Floral Nursery, Dubuque, Iowa; flowering plants.
 Harris, Joseph, Rochester, N. Y.; vegetable and flower seeds.
 Harrington, D. B. & M. S., Delavan, Wis.; potatoes and seed corn.
 Hawkins, W. W. & Sons, Lake George, Fla.; fruit and ornamental trees and shrubs.
 Hawley, R. D., Hartford, Conn.; flower and vegetable seeds, agricultural implements.
 Henderson, Peter & Co., New York; bulbs, plants and seeds.
 Herr, Albert M., Lancaster, Pa.; florist's plants.
 Higganum Mfg. Corporation, New York; farm, garden and flower seeds, plants and agricultural implements.
 Horsford, F. H. & Co., Charlotte, Vt.; wild flowers, shrubs and seeds.
 Hoskins, T. H., Newport, Vt.; fruits and seeds.
 Howe, G. D., North Hadley, Hampshire county, Mass.; potatoes.
 Hoyt, R. D., Bay View, Fla.; tropical and semi-tropical plants.
 Hoyt's Sons, Stephen, New Canaan, Conn.; Green Mountain grape.
 Hubbard, T. S. & Co., Fredonia, N. Y.; grape vines and small fruits.
 Huntington & Co., Indianapolis, Ind.; vegetable seeds.
 Idaho Pear Co., Lewiston, Idaho; Idaho pear.
 Jerrard, G. W. P., Caribou, Maine; potatoes and vegetable seeds.
 Johnson & Stokes, Philadelphia, Pa.; flower and vegetable seeds.
 Jones, Herbert A., Himrods, N. Y.; fruit and ornamental trees and shrubs
 Joosten, C. H., New York City; Dutch bulbs.
 Josselyn, G. S., Fredonia, N. Y.; small fruits.
 Karr, Geo. A., Philadelphia, Pa.; garden, flower and field seeds.
 Kedney & Carey, Maitland, Orange county, Fla.; nursery supplies.
 Kelsey, Harlan P., Highlands, N. C.; trees and plants.
 Kelsey, Fred W., New York; trees, shrubs, roses and plants.
 Kendall & Whitney, Portland, Maine; garden, field and flower seeds, agricultural and horticultural implements.
 Landreth, D. & Sons, Philadelphia, Pa.; vegetable and flower seeds.
 Leonard, S. F., Chicago, Ill.; flower and vegetable seeds.
 Lipsey, L. W., Citra, Marion county, Fla.; fruit and ornamental trees.
 Livingston, A. W. & Sons, Columbus, Ohio; garden seeds and implements.
 Lovett, J. T., Little Silver, N. J.; nursery supplies.
 Lyon, T. T., South Haven, Mich.; small fruit plants.
 Manning, J. W., Reading, Mass.; trees and ornamental shrubs.
 Mathews, Wm., Utica, N. Y.; greenhouse plants.
 Maule, W. Henry, Philadelphia, Pa.; vegetable seeds.
 McMath Bros., Onley, Accomack county, Va.; nursery and vegetable supplies.

- Meehan, Thomas & Son, Germantown, Philadelphia, Pa.; ornamental trees, vines, shrubs and fruits.
- Michel's Early Strawberry Plant Co., Judsonia, Ark.; Michel Early Strawberry.
- Miller, George W., Chicago; roses and miscellaneous plants.
- Moon, Wm. H., Morrisville, Bucks county, Pa.; nursery supplies.
- Moore, Delano, Presque Isle, Maine; vegetable seeds.
- Morehouse & Annis, Rochester, N. Y.; garden, flower and field seeds.
- Munson, T. V., Denison, Texas; nursery supplies.
- Nelson, Wm. K., Augusta, Georgia; fruit trees.
- Norton, G. H., Eustis, Fla.; nursery stock.
- Park, Geo. W., Fannettsburg, Pa.; flower seeds.
- Parry, William, Parry P. O., N. J.; small fruits, fruit trees and ornamental trees.
- Parsons & Sons Co., Kissena Nurseries, Flushing, N. Y.; hardy ornamental trees, flowering shrubs and vines.
- Peer, F. S., Mount Morris, N. Y.; vegetable seeds and fruit supplies.
- Peters, Randolph, Wilmington, Del.; garden seeds and nursery supplies.
- Pearce, John S. & Co., London, Ontario; field, garden and flower seeds.
- Perry, A. D. & Co., Syracuse, N. Y.; flower, field and garden seeds, implements and drain tile.
- Pierce, R. W., Indian Springs, Lake county, Fla.; nursery supplies.
- Pierson, F. R., Tarrytown, New York; flower seeds and vegetable plants.
- Pierson, M. F., Seneca Castle, N. Y.; potatoes.
- Pike County Nurseries, Louisiana, Missouri; nursery supplies.
- Pinney, Geo., Evergreen, Door county, Wis.; nursery supplies.
- Platt, N. S., Cheshire, Conn.; nursery supplies.
- Price & Reed, Albany, N. Y.; flower, vegetable and garden seeds, horticultural and agricultural implements.
- Rawson, W. W. & Co., Boston, Mass.; bulbs and small fruits.
- Reasoner Brothers, Manatee, Fla.; tropical and semi-tropical trees and plants.
- Reed, H. W. & Co., Waycross, Ga.; fruit and ornamental trees, seeds of southern forage plants, etc.
- Rice, J. B., Cambridge, N. Y.; vegetable seeds.
- Roberts, J. A., Malvern, Chester county, Pa.; fruit and ornamental trees, plants and vines.
- Roesch, Lewis, N. Y.; grape vines and small fruits.
- Root, J. B., Rockford, Ill.; seeds, bulbs, plants, garden tools, etc.
- Roser, E. L., Brittain, Summit county, Ohio; strawberry plants.
- Rumph, S. H., Marshallville, Ga.; fruit trees, grape vines, strawberry plants, etc.
- Saul, John, Washington, D. C.; greenhouse plants, garden and flower seeds.
- Scofield, E. J., Hanover, Wis.; strawberry and raspberry plants.
- Selover & Atwood, Geneva, N. Y.; fruit and ornamental trees, shrubs, vines, roses, etc.
- Shelmire, W. R., Avondale, Pa.; carnations.
- Smith & Kerman, St. Catharines, Ont.; fruit and ornamental trees, grape vines and small fruits.
- Smith, Wm. H., Philadelphia, Pa.; seeds and implements.
- Steel, W. C., Switzerland, Fla.; nursery stock.

- Storrs & Harrison Co., Painesville, Lake Co., Ohio; nursery supplies, flower and vegetable seeds.
- Strong, W. C., Newton Highlands, Mass.; trees, shrubs, roses and vines.
- Temple & Beard, Cambridge, Mass.; ornamental plants.
- Thorburn, Jas. M. & Co., N. Y.; vegetable and flower seeds.
- Tillinghast, I. F., La Plume, Pa.; vegetable seeds.
- Tryon, J. H., Willoughby, Ohio; grape vines.
- Tuttle, Sidney & Co., Bloomington, Ill.; nursery stock.
- United States Nurseries, Short Hills, N. J.; chrysanthemums, single dahlias and hardy perennials and greenhouse plants.
- Vaughan, J. C., Chicago, Ill.; vegetable and flower seeds.
- Vick, James, Rochester, N. Y.; vegetable and flower seeds.
- Waldo Nurseries, De Press & Godby, prop., Waldo, Fla.; fruits.
- Warfield, B. C., Sandoval, Ill.; Warfield's No. 2 strawberry.
- West Jersey Nursery Co., Bridgeton, N. J.; fruit and ornamental trees.
- Willard, W. O., Grinnell, Iowa; small fruit plants.
- Wilson, Samuel, Mechanicsville, Bucks Co., Pa.; strawberry plants, fruit trees, small fruits, grape vines, etc.
- Wilson, F. W., Chatham, Ontario; fruit and ornamental trees.
- Wilson, W. C., Astoria, Long Island, N. Y.; greenhouse and bedding plants, orchids, palms, etc.

CHAPTER IX.

TOOLS AND CONVENIENCES OF THE YEAR.

The devices which are recorded below are such as have been invented during the year or which have come into prominent notice during that time. Several of them are not new, but they have been, for the most part, little known.

PEARCE'S ORCHARD GANG PLOW.—(Figs. 2 and 3, page 175.) A valuable combined machine designed expressly for orchard work.—*J. A. Pearce, Grand Rapids, Michigan.*

A HORSE SCUFFLE-HOE.—(Fig. 4, page 175.) The knife can be secured to the frame of almost any plow-like cultivator. The knife is made of a simple piece of spring steel about two inches wide, sharpened on the front edge. It is excellent for cleaning walks of weeds, and to stir up ground which has "baked."—*Popular Gardening, August, 249.*

HORSE GRAPE-HOE.—(Fig. 5, page 175.) This implement has a light tapering pole with an iron extending in front of the horse's breast in a curve, with a slot in the end by which it is strapped to the collar. Back of the horse a piece is framed at right angles to which the whiffle-tree is attached, and also the lower ends of the handles, the middle of the handles being supported by a post farther back. The pole is on the right side of the horse, and on the under side of the pole near the back end is framed a standard sticking out in a slanting direction to the right at an angle of about 40°. The lower end of this standard carries a steel hoe four inches deep and ten inches wide, and this hoe cleans the ground almost up to the grape vine stems.—*E. H. Cushman, Ohio Farmer.*

ONION DRAG.—(Fig. 6, page 175.) A hand-drag for use upon onions both before and after the seed comes up. Twelve-penny nails answer for teeth.—*Fred. W. Card, in Popular Gardening, August, 271.*

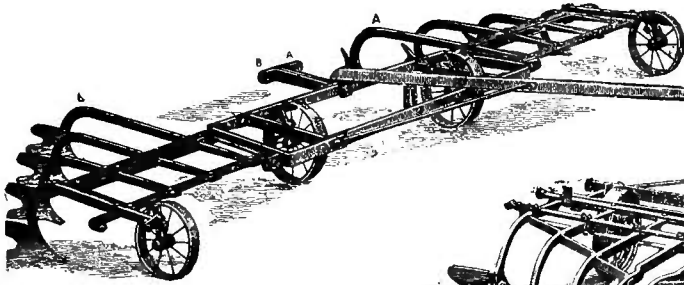

FIG. 2.

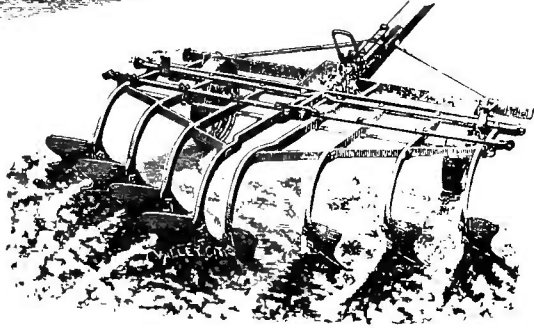

FIG. 3.

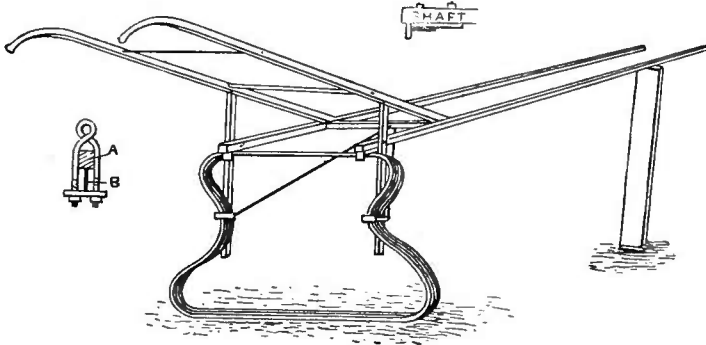

FIG. 4.

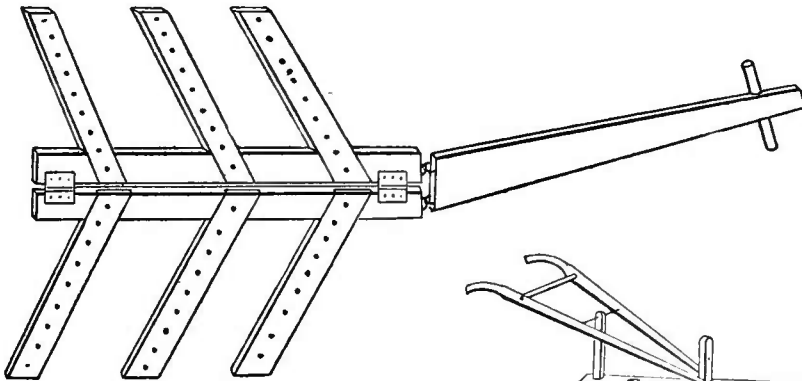

FIG. 6.

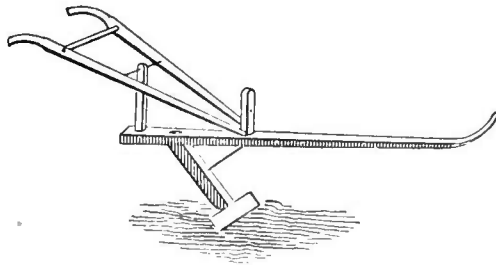

FIG. 5.



FIG. 10.

HOME-MADE PRUNING SHEARS.—(Fig. 7.) “Both blades are made of thin, hardened steel. From the bolt-hole in the movable shear a rod longer or shorter, to correspond with the length of pole used, runs to the lever shown at the bottom of the cut. * * The jaws of the shears must be ground at an angle somewhat more acute than that commonly employed for tailors’ shears. The highest part of each bevel must come against the bevel upon which it acts.”—*American Agriculturist*.

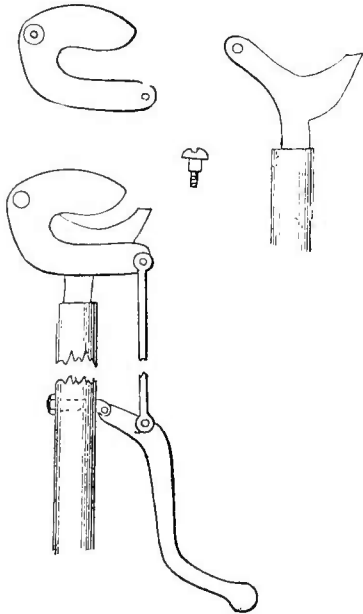

FIG. 7.

three-sixteenths of an inch apart. Two pieces of thin knife steel are riveted to the point *a*.—*S. T. Maynard, in Popular Gardening, June, 197.*

ECLIPSE POST BAR.—(Fig. 10, page 175.) A tool for aiding in setting posts in vineyards and elsewhere.—*Lagonda Manufacturing Company, Springfield, Ohio.*

FRUIT LADDER.—(Fig. 11, page 177.) A ladder made after the pattern of the figure is convenient for inserting into fruit trees, and for many other uses.—*Charles Gaylord, in Popular Gardening, August, 255.*

FRUIT LADDER.—(Fig. 12, page 177.) The sides are made of clear pine, 4½ inches wide by 12 feet long. The two bottom rounds are made of cleats 3 inches wide, and the upper ones of lighter stuff.—*S. C. Case, in Popular Gardening, November, 26.*

PRUNER FOR PRICKLY BUSHES.—(Fig. 8.) The knife can be made from an old file. This will be found a handy tool.—*Erwin Haltman, in Popular Gardening, December, 49.*

VINE GIRDLER.—(Fig. 9, page 177.) A knife for girdling the grapevine. The two blades should be about

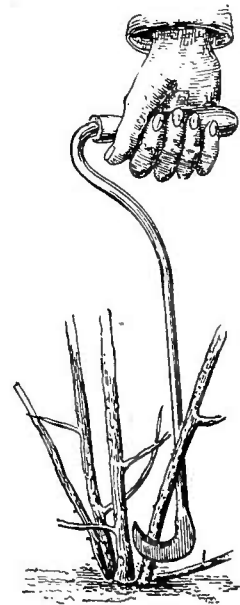

FIG. 8.

CLEVES' ANGLE TROWEL.—(Fig. 13, page 178.) “This handy digger was originally intended for digging plantains and other weeds from lawns, its slim blade, made strong by its angular form, being suited for prying and twisting; but it has also



FIG. 9.

found favor among the women as a flower cultivator for loosening the soil in pots, and among young plants for transplanting.”—*Floral Supply Company, Binghamton, N. Y*

PLANT PROTECTOR.—(Fig. 14, page 178.) This is a simple device for protecting young plants from cut-worms. *A* and *B* represent the two pieces of the device. These parts are thrust into the ground in such position as to form a box, as at *C*.—*W. B. Whitney, in Rural New-Yorker, May 4, 295.*

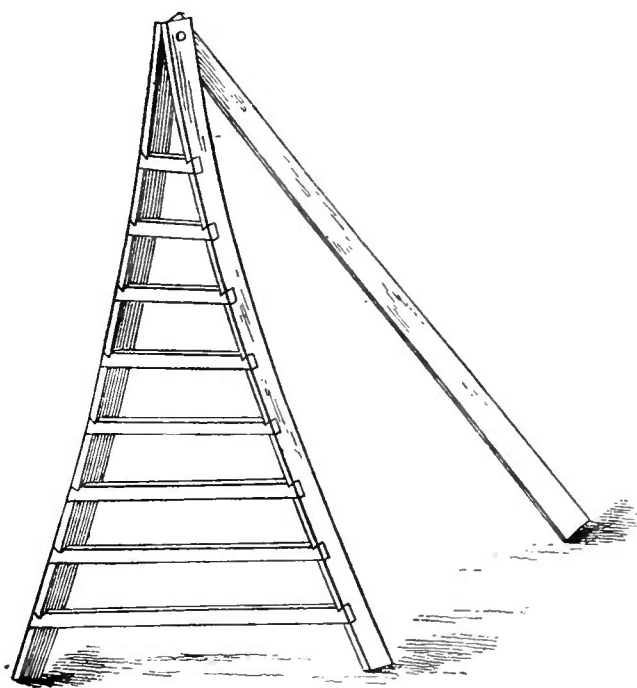

FIG. 12.

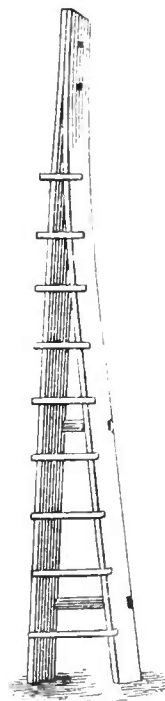

FIG. 11.

THE STRAWSONIZER.—(Fig. 15, page 179.) An English machine for distributing liquids or solids over fields. It is named for Strawson, the inventor. It will distribute poisons in a

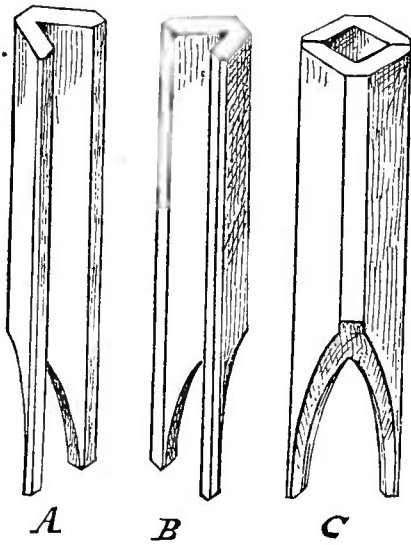

FIG. 14.

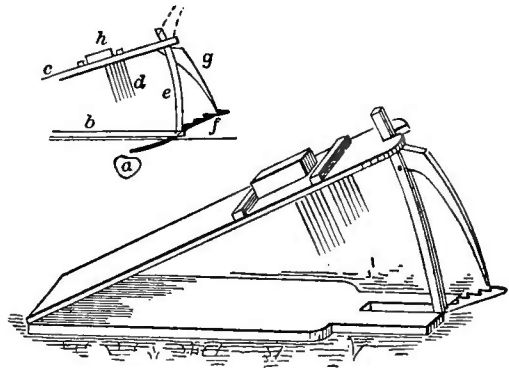

FIG. 16.

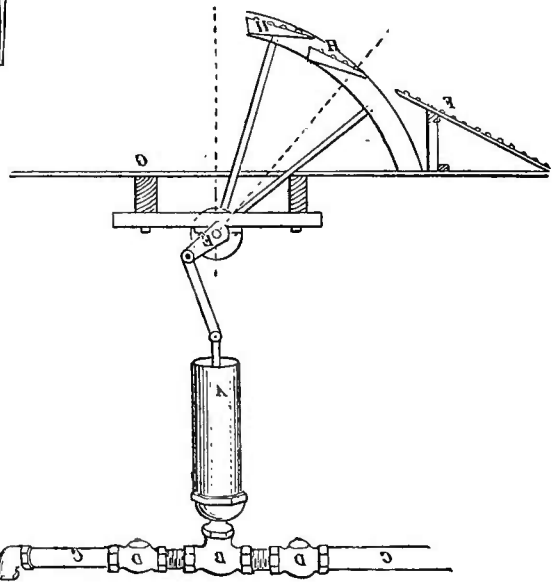

FIG. 18.



FIG. 13.

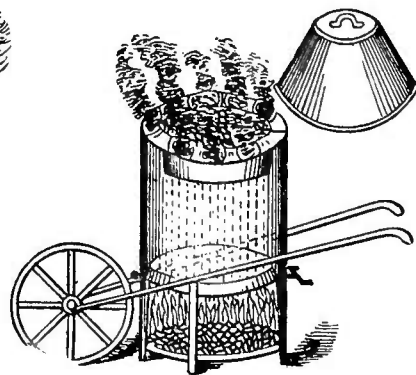

FIG. 20.

spray, and will sow fertilizer or grain. The machine is a light one for one horse, being constructed in great part of wood,

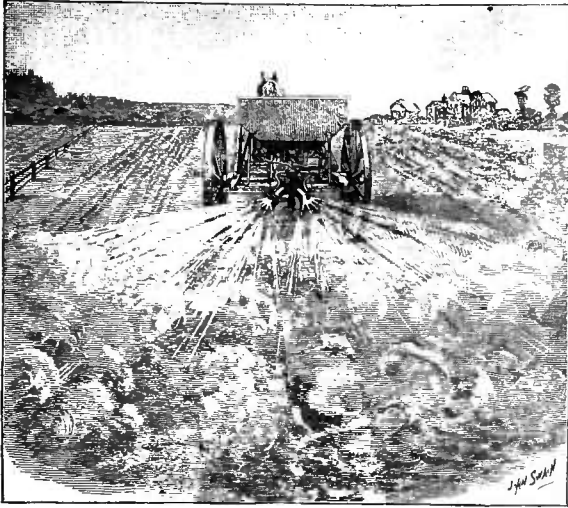

FIG. 15.

mounted on two iron wheels. The distributing power is obtained by a blast of air produced by a revolving fan, worked by the traveling wheels of the machine. As the material falls from the hopper it is caught by a blast of air and spread from the back of the machine. For solids a metal spreader is fixed, while liquids are sent through nozzles placed in different positions for various purposes. Small hand-power machines

are made for gardens, fruit plantations, and other purposes, as well as horse-power machines for farms. Special distributors are made for use in vineyards, for which purpose they are already in great demand in England. It appears to be one of the most useful of modern inventions.

MOLE TRAP.—(Fig. 16, page 178). “Two pieces of inch board, of the shape shown, seven inches wide and thirty inches long, are hinged together on one end. The iron trigger is ten inches long, its lower end somewhat like a flattened spoon or paddle and the upper end notched as shown. The upright post is curved to correspond with the sweep of the top board. On each side of the top are six teeth, either fastened directly on the board or riveted on a plate an inch wide and

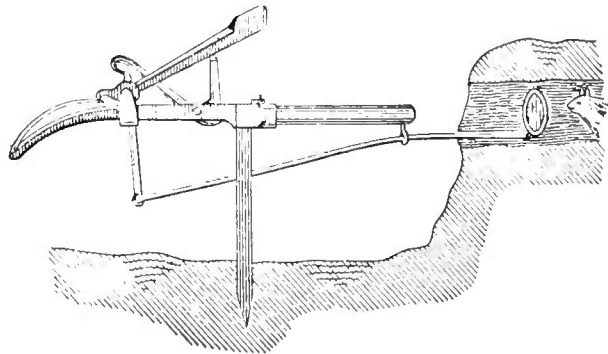

FIG. 17.

screwed on the board. The top board is weighted with a brick, a flat stone or a chunk of wood. Before setting the trap, put the foot firmly upon the part of the mole track upon which the trap is to rest, for the purpose of obstructing the run. Also press the teeth down into the soil, so there will be no obstruction when the trap is sprung. Then set the trap as shown in cut. The paddle part of the trigger should touch the surface of the ground exactly over the line of the track. The mole finding his accustomed path filled up, at once begins to re-open it, and heaving up the surface, springs the trigger, and is pierced by the teeth on one side or the other."—*Popular Gardening, May, 1867.*

SELF-ACTING ANIMAL GUN.—(Fig. 17, page 179.) A device invented and manufactured by *Foreman Brothers, Bidwell's Bar, California.*

HOME-MADE HYDRANT.—(Fig. 18, page 178.) This device can be used where water works do not exist. "Take a large barrel, place it on the left of some out-building at least 21 feet above the point of application, as each $2\frac{1}{10}$ feet of elevation gives us one pound, and we want to get a pressure of not less than 10 pounds per square inch. To fill the barrel we want a force-pump. This consists of a simple brass cylinder (iron would rust, and get rough inside) with a plunger. The lower end is reduced, and with a $\frac{3}{4}$ -inch nipple screwed to a $\frac{3}{4}$ -inch T having a valve at each side, both facing the same way. From the entrance side of the valve, carry a line of pipe to the cistern, letting the lower end reach within one inch of the bottom; run the other end into the line of pipe leading from the bottom of your barrel to your garden. *A* is the cylinder, made of brass, to be had at any brass foundry or machine shop, together with the reducer at the bottom; *B* is the $\frac{3}{4}$ -inch T, and *C* the pipe, which can be had at any machinists' supply shop at a price not exceeding five cents per lineal foot; *D D* are the check valves, can be had for about 25 cents each, *E* is the crank which alternately raises and depresses the piston of the pump. To get the motive power, we harness up "Old Dog Tray," get him up over the bridge *F*, and it won't take long before he will learn to work it the same as a tread-power from the steps *H H*. These must be made low, and near enough to require only small steps. So few have been able to construct such a machine, not from the lack of me-

chanical skill, but from the improper application of the force at hand with the resistance to be overcome, that a little explanation here of the philosophy of power and resistance may

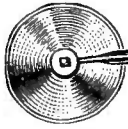

FIG. 19.

not be amiss. If the cistern is situated 11 feet below *A*, a weight of 5 pounds has to be lifted per square inch, and as the cylinder has an area of 4.9 square inches, 24.5 pounds have to be lifted at every stroke (it has, however, greater resistance to overcome, and if the barrel is to be 21 feet high, there is a resistance of 49 pounds against 24.5 lifting, not counting the friction). If the leverage from the fulcrum or center of the wheel (a wheel being only a continuous lever) is seven times greater than the distance from the center to the end of the crank, one pound power is able to overcome seven pounds resistance, consequently the animal should weigh one-seventh of 49 pounds, or seven pounds, but considering all outside influences, friction, etc., he ought to weigh 12 or 14 pounds."—*L. L. Esenhowe, in Popular Gardening, May, 171.*

LIGHTNING LAWN EDGER.—(Fig. 19.) A patented device, consisting of a revolving cutting disc, for trimming sod borders.—*Charles Everding, Branford, Conn.*

FROST PROTECTORS.—(Fig. 20, page 178.) Two devices, patented, for making a coal-tar smudge for protection from frost. The tar is held above the fire and drips down onto it.—*Popular Gardening, June, 204.*

SEED TESTERS.—(Figs. 21 and 22, page 182.) Two good and cheap lenses to aid in the detection of impurities and adulterations in seeds are offered by the *Whitney-Noyes Seed Company, Binghamton, N. Y.*

CHANDLER'S PATENT INDESTRUCTIBLE COPPER LABEL.—(Fig. 23.) A serviceable and durable label, with tag ends for securing it to the plant. The name



FIG. 23.

or description of the plant or tree can be written or indented on the label easily and legibly with a lead pencil or other

pointed instrument, pressing heavily and holding the label on the flat surface of an ordinary pocketbook. The inscription thus made is ineffaceable and indestructible, so that after the label has been in use for a length of time it can be thoroughly cleaned and brightened by simply putting into a hot fire.—*Johnson & Stokes.*

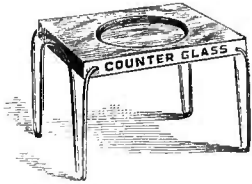

FIG. 21.

APPLE-SEED SEPARATORS.—(Fig. 24, p. 183.) An apparatus for separating seeds from apple pomace. “Construct a V-shaped hopper, as shown in Figs. 1 and 2, varying the length according to the amount of pomace and the water supply. Make the hopper of wood or galvanized iron, water-tight, say four feet square at the top and six inches by four feet at the bottom, and four feet deep. Make one side of the hopper double, and allow it to extend above at least six inches, the space between the walls being one inch. Let this double wall extend half way across the bottom, and leave a one-inch opening in the inside bottom in the middle. Now make a sieve of copper wire-cloth, $\frac{1}{2}$ -inch mesh, that will fit snugly two inches above the bottom of the hopper. Fasten it down on cleats with a button, so that it can be removed easily. Now cause a stream of water to pass

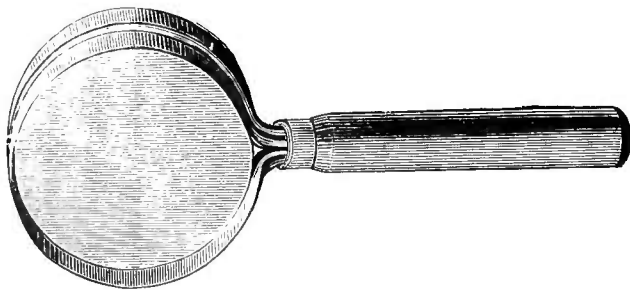
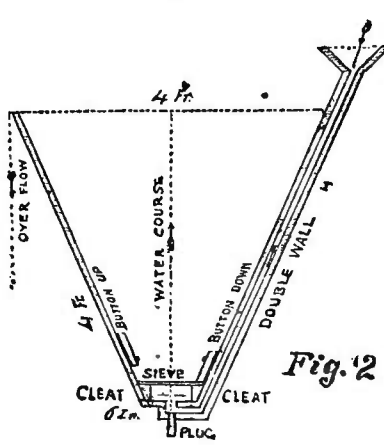
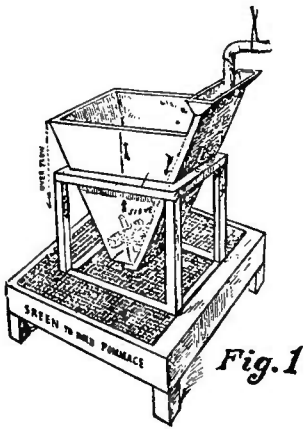

FIG. 22.

down the double wall of the hopper and through the bottom through the sieve. When it begins to overflow, have the pomace loosened up and throw in a few scoopfuls; stir it a little. The seed will all settle to the bottom, and the pomace will float off with the overflow.” The hopper is drained by a 2-inch plug in the bottom.

A second separator is shown in Fig. 3, which works after the manner of a gold-washing trough. The trough is "18 inches



wide and 6 inches deep; place cross partitions every 15 inches. These should be 3 inches high. The length of the trough is 16 ft." The pomace and water are turned on this trough. The seeds will lodge behind the partitions. — *T. S. Russell, in Rural New-Yorker, 1888.*

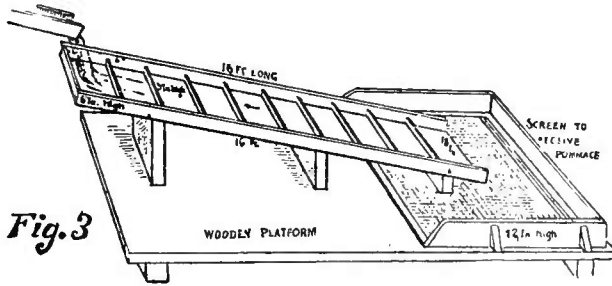

FIG. 24.

COOK'S APPLE PICKER. — (Fig. 25.) This device has been in use in some sections for two or

three years, and is now attracting general attention. It is undoubtedly the best implement of the kind yet perfected.

POTATO SORTER. — (Fig. 26, page 184.) A screen upon which the potatoes are poured slowly, for the purpose of sizing them. — *Orange Judd Farmer.*

ADAMS' VENTILATED BARREL. — (Fig. 27, page 184.) This is a patent barrel, made of splints, designed for the shipment of green fruits and vegetables in warm weather. — *Scientific American.*

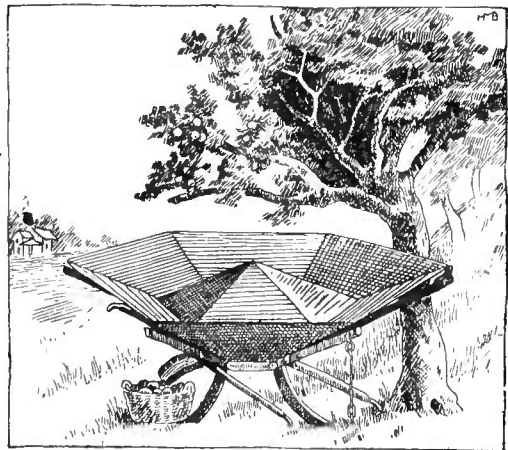

FIG. 25.

AN ORANGE WRAPPING MACHINE.—An apparatus for wrapping citrus fruits in tissue paper is said to have been perfected recently.

“A carrier moves the wrapper-paper forward to where the oranges are fed. A clamp then presses the edges of

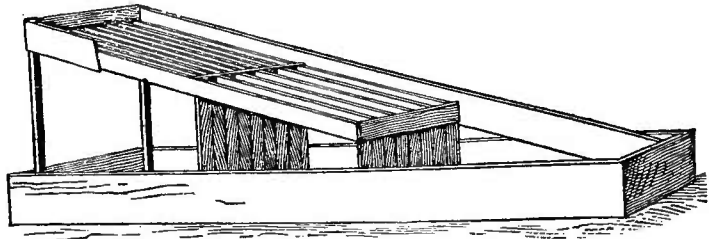

FIG. 26.

the paper in neck-like form around the fruit. The clamp and holder are quickly rotated, and by this means the wrapper is twisted around the orange, which is then dropped into a basket at the end of the machine ready for packing.”—*Confectioners' Union*.



FIG. 27.

MAXFIELD FRUIT CAR.—(Fig. 28.) A patent fruit car. The particular features “consist essentially in the novel construction of the car, whereby the same may be perfectly ventilated, and the fruit in transit preserved in a fresh condition.”—*Fruit Trade Journal, August 10*.

HANDY HOT-BED FRAME.—(Fig. 29, page 185.) The novel feature of this frame is the use of wagon-box rods for securing the sides together. The frame is then easily taken apart and stored.—*M. B. Newbern, in Popular Gardening, March, 123*.

WIND-TIGHT VENTILATOR.—(Fig. 30, page 185.) A device used by J. T. Anthony, Chicago, for keeping wind from houses. “The opening in the roof is cased clear around inside with a strip which projects about an inch above the surface of the roof, and the weather strip on the outside is

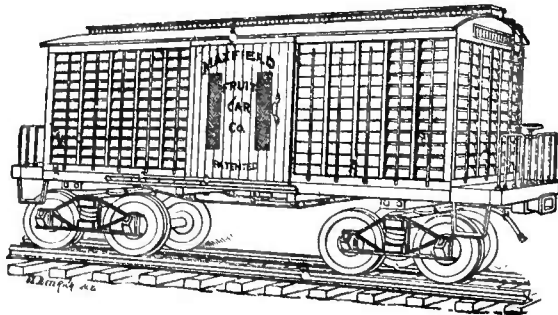

FIG. 28.

carried around three sides of the ventilator sash."—*American Florist, October 15, 115.*

VENTILATOR-SHAFT SUPPORT.—(Fig. 31.) A device used in

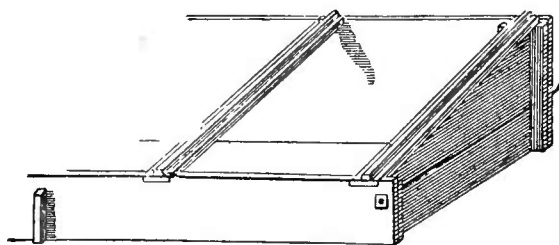

FIG. 29.

the houses of C. S. Price, Lansdowne, Pa., to lessen and lighten shafting bearings. The iron columns supporting the roof are cut in two and provided with a four-way tee, through which the shaft runs. "This tee is $1\frac{1}{4}$ inches one way to connect with the $1\frac{1}{4}$ -inch column, and 1 inch the other way,—the shafting being of 1-inch pipe,—the threads are reamed out the 1-inch way, thus giving shafting room to revolve easily."—*American Florist, August 15, 10.*

AUTOMATIC VENTILATOR.—(Fig. 32, page 186.)

"First, there is a frame of wood, strongly built, *B B H.* * * In the hollow thus formed are placed the ends of elliptic-shaped springs made of heavy zinc. * * These springs are bent and their ends,

after lapping at the center of the upper part, are riveted together." When the house becomes warm the zinc expands and the springs open, "pushing up the pin *H*, which in its

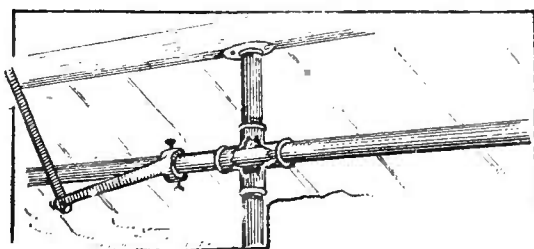

FIG. 31.

Esenhower, in Popular Gardening, January, 73.

A—12.

turn pushes up the lever *C*, which working the same on *E*, turns the shaft *D*" and raises the sash. "The shafting of this device is made of ordinary $\frac{1}{2}$ -inch gas-pipe resting on brackets, fastened to the back wall with staples."—*L. L.*

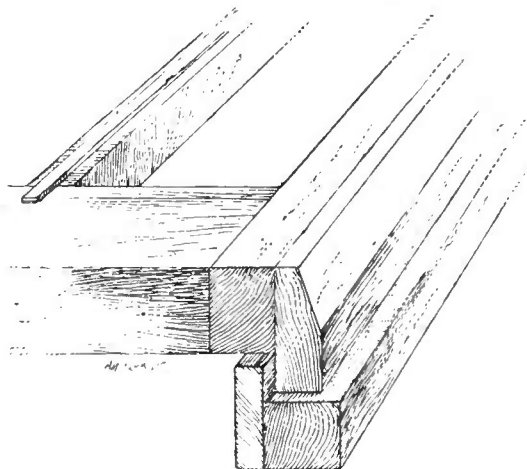

FIG. 30.

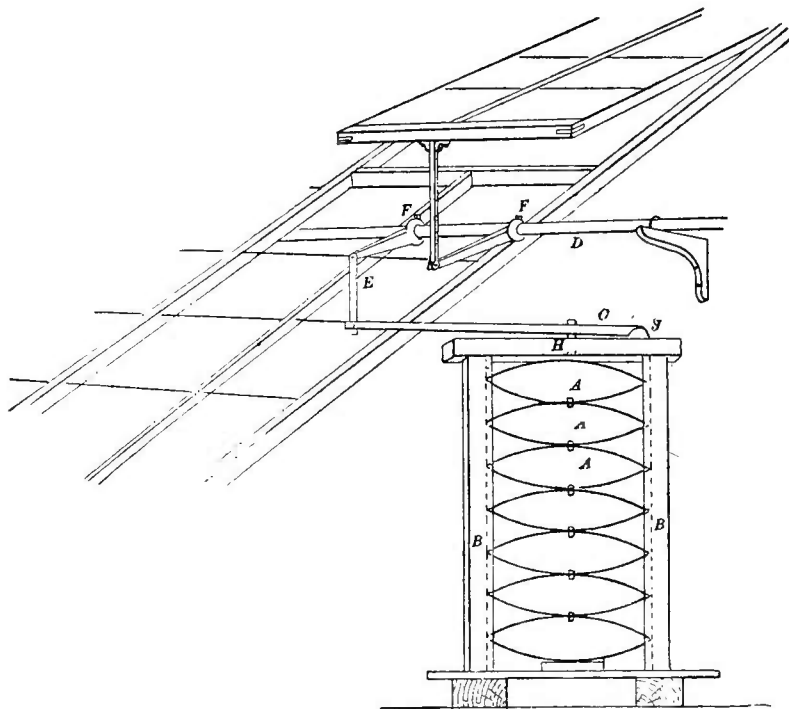

FIG. 32.

CHEAP VENTILATOR.—(Fig. 33.) An iron rod is secured to the movable end of the sash. To the lower end of the rod is attached a cord, which runs over a small pulley and is then secured to a clothes-line which runs the length of the house. This line runs through double blocks at one end of the house in such manner as to cause the sash to raise by its movement.—*American Florist*, November 15, 1861.

CAT GUARD FOR GREENHOUSES.—(Fig. 34, page 187.) “An English gardener has hit upon the contrivance shown in the en-

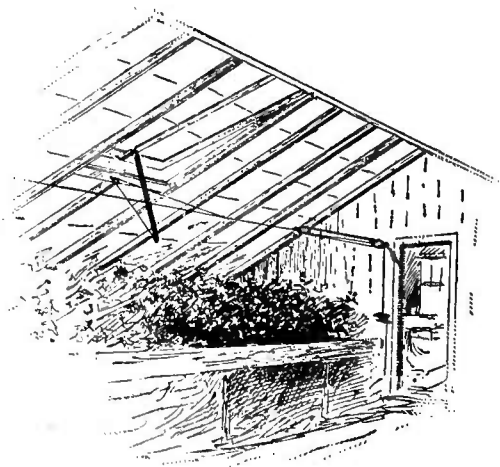

FIG. 33.

graving. He cuts strips of tin, about $\frac{1}{8}$ inch in width and 2 inches long (*b*, Fig. 1), and arranges each two in the form of a cross. They are then soldered on a flat piece of tin 2 or 3 inches wide and of any length desired (*c*, *d*, Fig. 2.) The ends are now turned up in the manner shown at *e*, and cut to a sharp point. As soon as we find the soil in our beds disturbed by cats, we put one or more of these contrivances on the ground, points upward, and cover the flat pieces with earth. The cats usually come back to the same spot, but they soon leave when their feet come in contact with the sharp points."—*W.*

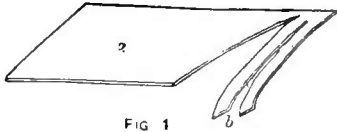

FIG 1

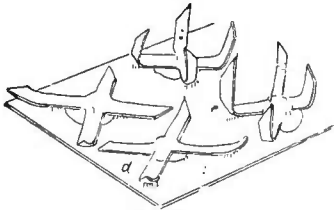

FIG 2

FIG. 34.

N. Summers, in Popular Gardening, December, 70.

WATERING PLANTS BY MEANS OF PERFORATED PIPES.—(Figs. 35 and 36.) Ordinary water pipes are laid along the house, from which risers are taken to attach to a horizontal perforated

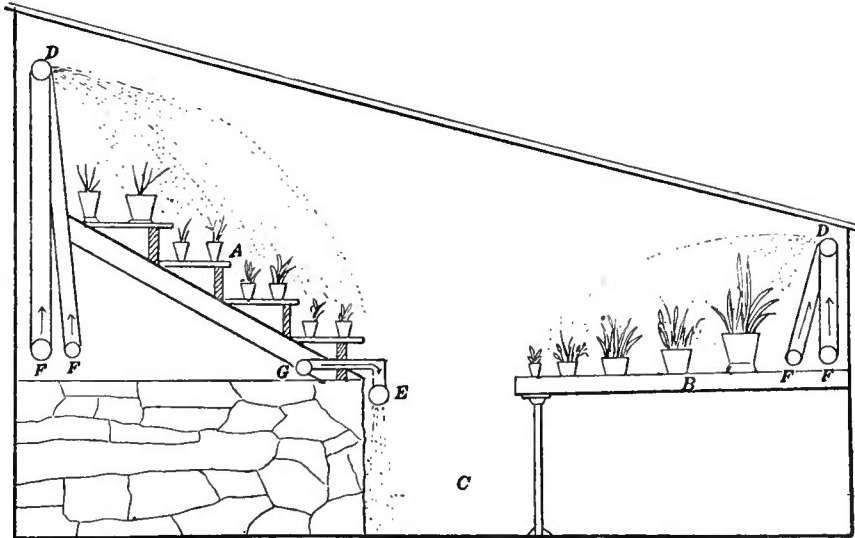

FIG. 35.

pipe which is fastened to the wall over the bench. Adapted to cool houses that need to be sprinkled often. Fig. 36 shows ground plan.—*W. A. Manda, in Popular Gardening, April, 142.*

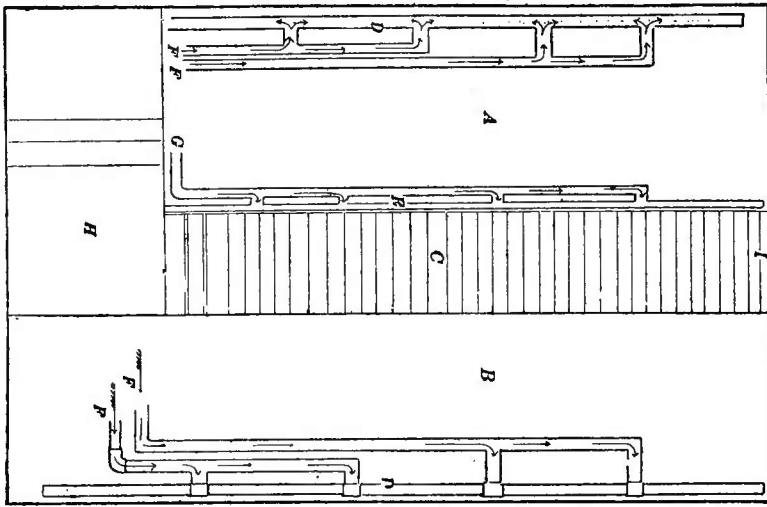

FIG. 36.

TOBACCO TROUGH.—(Fig. 37.) This is a trough secured to pipes in a greenhouse, and is used for evaporating tobacco-water for the purpose of destroying aphids and other pests. — *American Florist*, October 1, 89.

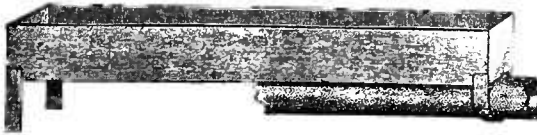

FIG. 37.

SIMPLE ENGLISH FUMIGATOR.—(Fig. 38.) This apparatus consists of a

copper tobacco pipe with a tube leading from either side, through which smoke can be blown.

PROPAGATING TANK.—(Fig. 39, page 189.) “The tank consists of a long wooden box made of matched boards, and put together with paint between the joints to make the box water tight. The box should be about three feet wide and ten inches

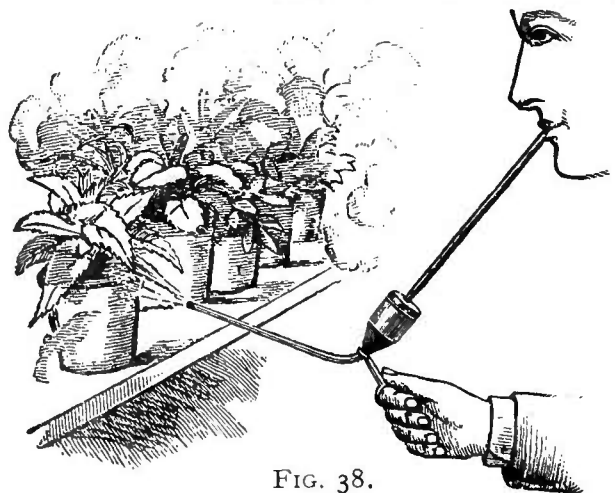

FIG. 38.

deep, and may be from ten to thirty feet long, according to the space required. In the middle of the box is a partition, extending nearly the whole length of the box, and on the inside,

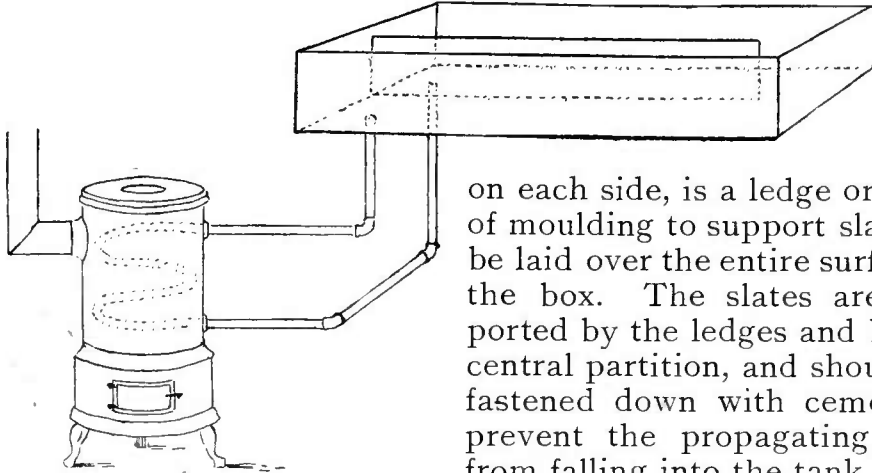

FIG. 39.

on each side, is a ledge or piece of moulding to support slates to be laid over the entire surface of the box. The slates are supported by the ledges and by the central partition, and should be fastened down with cement to prevent the propagating sand from falling into the tank. One slate is left out near the end,

next the fire, to enable the operator to see the water and to keep it at the right level. On the slates sand is spread, in which the cuttings may be struck, the sand nearly filling the box.

“At one end of the box is placed a common cylinder stove, with pipe to the chimney. Inside the stove is a lead or iron pipe (iron is the best) bent in a spiral round the inside of the stove. This coil, which is directly in the fire, is connected by iron pipes with the tank, one pipe leading to one side of the partition and the other to the opposite side, as shown in the drawing. If water is placed in the tank it will fill the pipes and form a continuous circulating system through the pipes and up one side of the box past the end of the partition, and down the other side. A fire in the stove causes the water

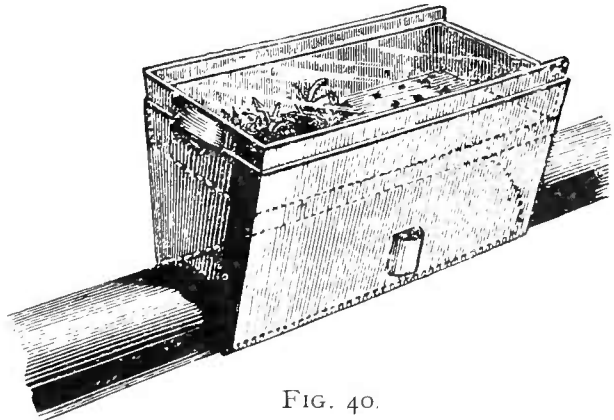

FIG. 40.

to circulate through the tank and impart to the cutting bed a genial warmth, suitable for young cuttings and seedlings.”—*Charles Barnard, American Garden, September, 320.*

A ZINC PROPAGATOR.

—(Fig. 40, page 189.)

This consists of a tank made to fit any hot water or steam pipe, about 15 inches long, 6 inches wide and 7 inches deep, with one inch of water in the bottom. and a perforated dish, 5 inches deep, above. The cuttings are placed

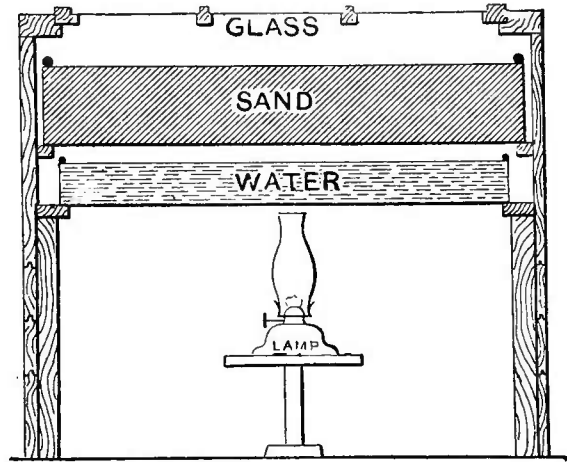

FIG. 41.

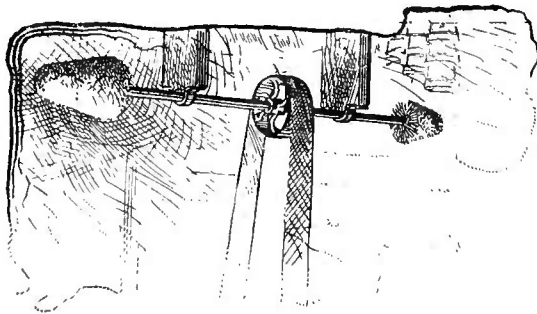

FIG. 42.

in the latter. The whole is made of zinc, with a small feeder on one side, and is less liable to get broken than similar propagators made of clay. This device is put out by an English firm.

PORTABLE PROPAGATING CASE.—(Fig. 41.) A simple case, in which the heat is supplied by a kerosene lamp. It can be made 4 by 3 feet, with a total depth

of 2 feet.—*Mary A. Newcome, in Popular Gardening, January, 83.*

POT WASHER.—(Fig. 42.) “The brushes on the end of the shaft are made of a shape to fit the inside of the pot, and several sizes are used, though one brush does the work for a number of sizes

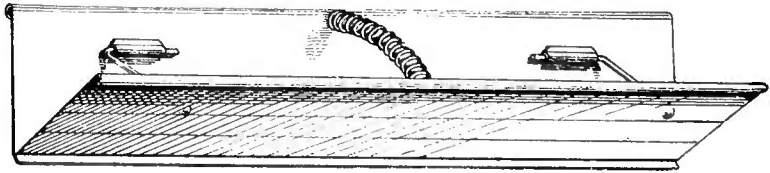

FIG. 43.

of pots.” The machine can be driven either by steam or hand power.—*American Florist, July 1, 549.*

TRACY'S SEED-PLANTER.—(Fig. 43, page 190.) An unpatented apparatus for distributing seeds for test at equal depths

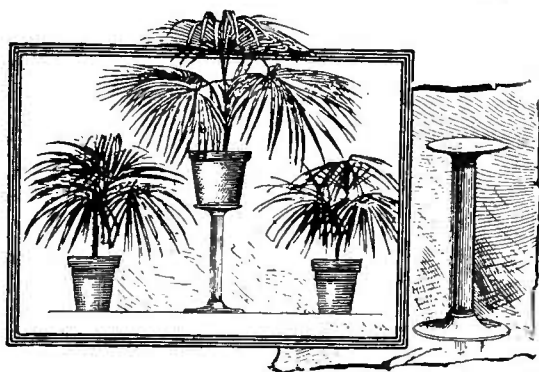

FIG. 44.

in the soil. "It consists of two strips of heavy tin plate nearly three inches wide, hung upon two wire pivots or hinges some two inches long. At their upper edges and equidistant from either end, the plates are joined by a firm spiral spring, which serves to throw the upper edges apart, and to cause the lower edges to join. This

trough is now filled with the required number of seeds, and is then inserted into the earth to a given depth, when the fingers push inward on the spring and the trough opens and delivers the seeds."—L. H. Bailey, in *Bulletin No. 7, Cornell University Experiment Station.*

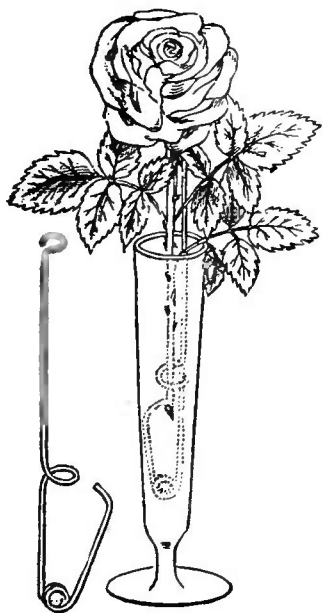

FIG. 46.

HARRIS' IRON PLANT STAND.—(Fig. 44.) Stand made of iron pipe, with flange on top and bottom, and used for economizing room in greenhouses and for displaying plants.—*American Florist, August 15, 6.*

PLANT SUPPORT.—(Fig. 45.) A simple wire device for attachment to a plant stake.

FLOWER SUPPORT — (Fig. 46.) A simple and very useful device for holding a single flower in place in a glass or vase. Its application can be readily seen in the engraving.—*Popular Gardening, Feb., 108.*

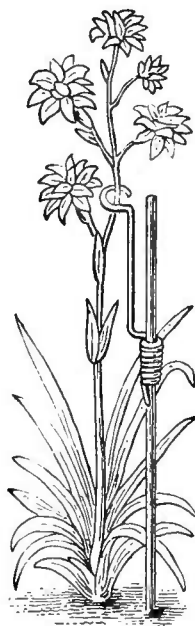

FIG. 45.

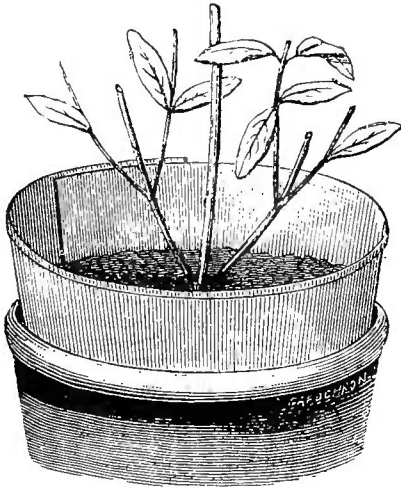

FIG. 49.

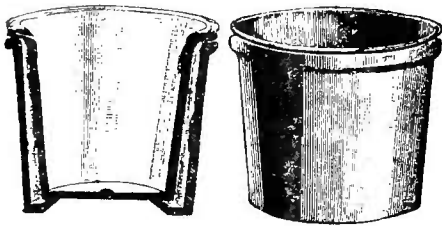

FIG. 47.

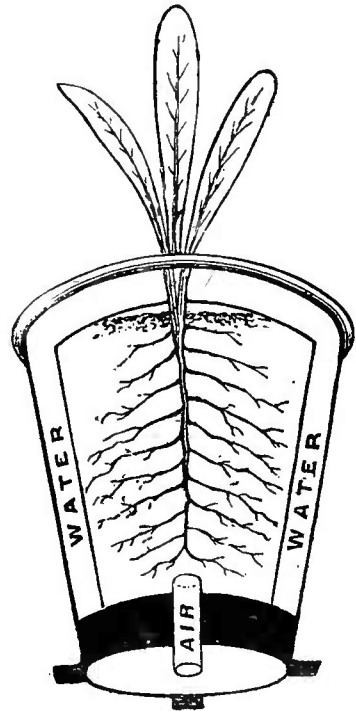

FIG. 48.

IMPROVED FLOWER POT.—(Figs. 47 and 48.) This pot is designed to regulate the moisture, air and temperature about the roots of the plant, by means of a water chamber in the wall and by a cement bottom which aerates the soil. It is essentially a double pot.—*Gardeners' Magazine*.

POT COLLAR.—(Fig. 49, page 192.) A simple and useful device for holding soil on the top of pots.—*Gardeners' Chronicle*, September 14, 307.

CHAPTER X.

RECENT HORTICULTURAL LITERATURE.

I Register of Experimental Horticulture.

AN INDEX TO THE HORTICULTURAL INVESTIGATIONS CONDUCTED BY THE CONGRESSIONAL EXPERIMENT STATIONS SINCE THE PASSAGE OF THE "HATCH BILL,"* AND BY THE UNITED STATES DEPARTMENT OF AGRICULTURE, THE MASSACHUSETTS STATE EXPERIMENT STATION, THE NEW YORK STATE EXPERIMENT STATION, AND THE CANADIAN EXPERIMENT STATIONS DURING THE SAME PERIOD.

It is impossible to draw a sharp line of separation between horticulture and other divisions of general agriculture ; but the following lists have been made sufficiently comprehensive to include all that can possibly be called horticulture, and some entries may, perhaps, belong rather to general farming. Many entries of insects and fungi have been made, but they are such as particularly concern the horticulturist.

§ I. TITLE INDEX.

Explanation.—The figures in the left margin are the numbers of bulletins and volumes of reports. If the number stands independently it indicates that the bulletin in question contains only horticultural matter ; but when it stands in a parenthesis, the bulletin contains other matter than that which is indexed.

ALABAMA :

A. Agricultural Experiment Station.

- (1.) Experiments with Table Corn, Experiments with English Peas, Experiments with Irish Potatoes, Notes on Raspberries, Notes on Strawberries. July, 1888. *J. S. Newman.*

*March, 1887.

NOTE.—In many instances, the date of bulletins is much earlier than the actual publication, and it is to be expected that some bulletins dated 1889 will arrive too late for insertion here. Such will be recorded in future annals.

ALABAMA (*Ag. Exp. Sta.*), continued.

- (2.) Varieties of Cabbage, Tomatoes, Notes on Varieties of Cantaloupes, Varieties of Watermelons. Oct., 1888. *J. S. Newman.*
 - (3.) Report of Experiments with Corn, Sweet Potatoes, Ground Peas, Turnips and Grapes. Jan., 1889. *J. S. Newman.*
 4. Strawberry Culture, Grape Culture and Pruning, Raspberry Culture. Feb., 1889. *J. S. Newman.*
 - (7.) Experiments with Vegetables [Tomatoes, English Peas, Beans, Irish Potatoes]. Oct., 1889. *Jas. Clayton.*
 9. Nematode Root-Galls.—A Preliminary Report on the Life History and Metamorphoses of a Root-Gall Nematode, *Heterodera radiculicola* (Greeff) Mull., and the Injuries Produced by it upon the Roots of Various Plants. Dec., 1889. *Geo. F. Atkinson.*
- B. Canebrake Experiment Station.*
- (1.) Experiments with Irish Potatoes, Experiment with Peas, Experiment with Lettuce, Experiment with Beets, Experiments with Beans. July, 1888. *W. H. Newman.*
 2. Experiment with Cantaloupes, Tomatoes, Keeping Qualities of Irish Potatoes, Fruit Trees; Cultivation vs. Clover Sod. Oct., 1888. *W. H. Newman.*
 - (6.) Vegetables [Irish Potatoes, English Peas, Radishes, Tomatoes, Winter-Grown Cabbage Plants, Cantaloupes], Grapes. Oct., 1889. *W. H. Newman.*

ARKANSAS :

3. Peach-Tree Borer, Codlin Moth. April, 1888. *S. H. Crossman.*
7. Grapes, Strawberries. Nov., 1888. *E. S. Richman.*
- (10.) Keresene as an Insecticide, The Tarnished Plant Bug (*Lygus lineolaris*, Beauv.). June, 1889. *C. W. Woodworth.*
- (11.) Strawberries. Sept., 1889. *E. S. Richman.*
- (1st report.) Catalogue of Fruits on the Experiment Station Grounds, Potatoes. The Grape Leaf-Folder (*Desmia maculatis*, Westw.), *C. W. Woodworth.* The Apple Leaf-Rust (*Gymnosporangium*). 1888.
- (2d report.) Potatoes. *A. E. Menke.* Strawberries, Sweet Potatoes, Seed Germination Tests, Experiments with Vegetables. *E. S. Richman.* 1889.

CALIFORNIA :

79. Experiments on the Cause and Avoidance of Injury to Foliage in the Hydrocyanic Gas Treatment of Trees. May, 1888. *F. W. Morse.*

CANADA :

- A. Agricultural College (Guelph).*
- VIII. Grapes. [April, 1887?] *J. Hoyes Panton.*
 - XV. Apples. Aug., 1887. *J. Hoyes Panton.*
 - XXVII. Cultivation of Raspberries. April, 1888. *J. Hoyes Panton.*
 - XXXVII. Strawberries. April, 1889. *J. Hoyes Panton.*
- B. Central Experimental Farm (Ottawa.)*
- (2.) Testing the Vitality of Seeds, Potatoes, Large Fruits, Small Fruits. Dec., 1887. *Wm. Saunders.*
 5. Strawberry Culture. Aug., 1889. *W. W. Hilborn.*

CANADA, continued.

- (1887 report.) Report of Entomologist and Botanist [accounts of many insects injurious to vegetables and fruits]. *James Fletcher*. Report of the Horticulturist [brief reports upon various fruits]. *W. W. Hilborn*.
- (1888 report.) Report of Entomologist and Botanist [accounts of various injurious insects]. *James Fletcher*. Report of the Horticulturist [list of fruits growing on the farm, and brief reports of various fruits]. *W. W. Hilborn*.

COLORADO:

- (2.) Vegetables [Beans, Beets, Carrots, Peas]. Dec., 1887. *A. E. Blount*.
- (4.) Potatoes. Feb., 1888. *James Cassidy*.
6. Insects and Insecticides. Jan., 1889. *James Cassidy*.
- (7.) Potatoes. April, 1889. *James Cassidy and D. O'Brine*.
- (1st report.) Notes on Insects and Insecticides, Notes on Orchard and Small Fruits, Notes on Garden Vegetables, Notes on the Leafage and Maturity of Fruit and Ornamental Trees. 1888. *James Cassidy*.

DAKOTA (South Dakota).

1. Notes on the Growth of Trees in the College Grounds. Nov., 1887. *Chas. A. Keffer*.
3. Arbor Day. April, 1888. *Chas. A. Keffer*.
- (4.) The Experimental Orchard, Small Fruits, Experiments in the Germination of Forest Tree Seeds, Garden. July, 1888. *Chas. A. Keffer*.
5. Garden Notes [tests of many vegetables]. Oct., 1888. *Chas. A. Keffer*.
13. Department of Entomology [notes of various insects and insecticides]. April, 1889. *J. H. Orcutt*.

DELAWARE.

- II. Horticulture and Entomology [outline of work]. Sept., 1888. *M. H. Beckwith*.
- III. Department of Botany and Plant Pathology [outline of work on Peach Yellows, Black Rot of the Grape, Grape Mildew, Scab of the Apple and Pear, The Strawberry Blight, Peach Leaf Curl]. Dec., 1888. *Frederick D. Chester*.
- IV. Injurious Insects. May, 1889. *M. H. Beckwith*.
- V. Seed Testing. June, 1889. *Frederick D. Chester*.
- VI. A Summary of the Station's Experiments on the Black Rot of Grapes. Oct., 1889. *Frederick D. Chester and M. H. Beckwith*.

FLORIDA.

- (1.) Potatoes, Asparagus, Celery, Cauliflower, Rhubarb, Orange trees, Apple trees, Pears, Plums, Peaches, Chestnuts and various notes. Apr., 1888. *J. Kost*.
- (2.) Strawberries, Onion, Melons, Early Corn. *J. F. Appell*. The Peach Curculio, The Peach Root-Knot, The Corn Aphis. *Wm. H. Ashmead*. Report on the "Foot-Rot" and "Scab" of Citrus trees, and on the Prevention of Orange "Rust." *A. H. Curtiss*. May and June, 1888.

FLORIDA, continued.

4. Peach Growing in Florida. Jan., 1889. *James P. DePass* and *James C. Neal*.
 (7.) Cucumbers. Oct., 1889.

GEORGIA :

- (2.) The Imported Cabbage Butterfly. Jan., 1889. *J. P. Campbell*.
 (3.) Entomology [the Melon-Worm, the Pickle-Worm, the Harlequin Cabbage-Bug]. Apr., 1889. *J. P. Campbell*.

ILLINOIS :

6. A Bacterial Disease of Corn. Aug., 1889. *Thomas J. Burrill*.

INDIANA.

15. Concerning the Potato Tuber. June, 1888. *J. C. Arthur*.
 18. Experiments with Vegetables [Potatoes, Sweet Corn, Onions, Peas, Sugar Beets, Japanese Vegetables]. Jan., 1889. *James Troop*.
 19. Spotting of Peaches and Cucumbers. Jan., 1889. *J. C. Arthur*.
 20. Experiments in Cross-Fertilization, The Culture of Tropical Ferns. Jan., 1889. *Pierre Van Landeghem*.
 25. Entomological Experiments [experiments in rearing the Plum Curculio, and other notes]. June, 1889. *F. M. Webster*.

IOWA :

- (1.) Notes on Crossing. May, 1888. *A. A. Crozier*.
 (2.) Corn Tassels, Silks and Blades. *R. P. Speer*. Arsenic Experiments. *C. P. Gillette*. Promising New Cherries. *J. L. Budd*. Aug., 1888.
 (3.) Characteristics of Hardy and Tender Fruit Trees. *R. P. Speer*. Some Injurious Fungi. *A. A. Crozier*. Promising New Pears. *J. L. Budd*. Analysis of Apples. *G. E. Patrick*. The Work in Crossing. *A. A. Crozier*. Nov., 1888.
 4. Wild Plums. *R. P. Speer*. A Chemical Study of Apple Twigs. *G. E. Patrick*. An Investigation of Apple Twigs. *Byron D. Halsted*. Propagation of Trees and Shrubs from Cuttings. *John Craig*. Some Suggestions concerning the Corn Root-Worm. *Herbert Osborn*. Feb., 1889.
 (5.) Important Injurious Insects, Preparation of Insecticides, Experiments with Pyrethrum, Apparatus for Applying Insecticides. May, 1889. *C. P. Gillette*.
 (7.) Codling Moth Experiments. *C. P. Gillette*. The College Vineyard. *J. L. Budd*. Nov., 1889.

KANSAS :

3. Observations on Two Insect Pests [Apple-Twig Borer and Apple Flea-Beetle]. June, 1888. *E. A. Popenoe*.
 (1st Report). Spraying in the Apple Orchard, Observations upon Injurious Insects, Trials of Varieties of Potatoes, Trials of Varieties of Peas, Trials of Varieties of Tomatoes. *E. A. Popenoe*. Experiments in Fertilization of Varieties of Corn, Germination of Weed Seeds, The Fung[o]us Parasites of Weeds. *W. A. Kellerman*. 1888.

KENTUCKY :

- 16. Potato Experiments. Dec., 1888. *M. A. Scovell* and *A. M. Peter*.
- (18.) Notes on the Treatment of an Old Apple Orchard. April, 1889.
- 22. Potato Experiments. Dec., 1889.

LOUISIANA :

- (11.) Potatoes, 1887. *Wm. C. Stubbs*.
- (16.) Potatoes, Tomatoes, Peas. Oct., 1888. *Wm. C. Stubbs*.

MAINE :

- (24.) Tests of Varieties [Potatoes, Peas]. May, 1888. *W. H. Jordan*.
- 2. Second Series. The Apple Maggot. 1889. *F. L. Harvey*.
- (1888 report.) Germination Experiments, Potato Scab, Injurious Plants, Injurious Insects [the last extended]. *F. L. Harvey*.

MARYLAND :

- 2. Cutting Seed Potatoes for Planting. Sept., 1888. *W. H. Bishop*.
- 4. Experiment Orchard. Mar., 1889. *W. H. Bishop*.
- (5.) Horticultural Department and Field Experiments. June, 1889.

MASSACHUSETTS :

A. *Hatch Experiment Station.*

- 1. Division of Entomology. *Charles H. Fernald*. Horticultural Department [Plant Bed Cloth as a substitution for Glass, Protection of Peach Buds from Injury by Cold, Girdling Apple Trees to Produce Fruitfulness, Girdling the Grape Vine to Hasten Ripening of the Fruit, Protecting Trees from Mice]. *S. T. Maynard*. July, 1888.
- 2. Division of Entomology [the Grape Vine Leaf-Hoppers, Ants, Alum not Destructive to Currant Worms, Poisonous Doses of Insecticides]. *Charles H. Fernald*. Division of Horticulture [Report on New and Standard Varieties of Fruit, the Effect of the Different Fertilizing Elements upon the Time of Maturing of Crops, Liquid Manure for Plants under Glass, Protecting Young Trees from Mice, Sulphur as an Insecticide and Fungicide]. *S. T. Maynard*. Oct., 1888.
- 4. Experiments in Heating Greenhouses, Glazing Experiment, Evaporated Sulphur for the Destruction of Mildew and Insects in Greenhouses, The Plum Wart, Testing New Varieties [Potatoes, Beans], List of Fruits. April, 1889. *S. T. Maynard*.
- 6. Greenhouse Heating, Strawberries. *S. T. Maynard*. Fungous Diseases of Plants [Introductory, Black-Spot of Rose Leaves, Black-Knot of the Plum, The Potato Blight and Rot]. Oct., 1889. *James Ellis Humphrey*.

B. *State Experiment Station.*

- (6th report.) Experiments with Potatoes, Roots and Miscellaneous Crops. Potato Scab, by *James Ellis Humphrey*. 1888.

MICHIGAN :

- 31. Notes on Tomatoes, Notes on Peppers, Notes on Onions, Notes on Strawberries, Lists of Fruit and Ornamental Plants Growing at the College, Calendar of Trees and Shrubs, Influence of Certain Chemicals upon Germination, An Experiment in Apple

MICHIGAN, continued.

- Culture, Miscellaneous Notes, Bud Variations, Brief Potato Notes, Notes on Crossing and Hybridizing, Which Flower in the Cluster Makes the Apple? Why are Young Trees Barren? Germination of Seeds which have been kept on Ice, Growth of Plants from Soaked Seeds which have been dried, What do we get in Lawn Grass Seeds? Trees as Shrubs, Effects of Last Winter, "Water-proof Fibre" Cloth for Cold Frames. Nov., 1887. *L. H. Bailey.*
33. Hints for Arbor Day. March, 1888. *W. J. Beal.*
39. Experiments with Insecticides. Sept., 1888. *A. J. Cook.*
40. Quantities of Seed for Given Lengths of Drill, Experiment in Hybridizing, Notes on Radishes, Notes on Germination, Effects of Latitude on Season of Flowering and Fruiting. Oct., 1888. *L. H. Bailey.*
48. Potatoes, Kale, Experiments with Squashes, Tomatoes. April, 1889. *L. H. Bailey and L. R. Taft.*
53. Spraying with the Arsenites. Aug., 1889. *A. J. Cook.*
55. Fruit Testing at the South Haven Sub-Station. Dec., 1889. *T. T. Lyon.*

MINNESOTA :

- (1.) Reports on Russian Apples. Jan., 1888. *Edward D. Porter.*
- (3.) Our Russian Apples at the Opening of their Fourth Season, Natural and Artificial Fertilization of Plants. July, 1888. *Samuel B. Green.*
- (5.) Propagation of Russian Willows and Poplars from Hard Wood Cuttings, Native Plums, Comparative Tests of Varieties of Cabbage. *Samuel B. Green.* New Method of Potato Culture. *Charles Pomeroulie.* Jan., 1889.
- (7.) Construction of Greenhouse Walls, Comparative Tests of Varieties of Potatoes. April, 1889. *Samuel B. Green.*
- (1888 report.) Insecticides and Fungicides on Potatoes, New Greenhouse, Grapes, Differences in the Seeds of Minnesota Grapes, Preparation of Seed Bed for Onions, Fertilizers, Different Methods of Cutting Potatoes, Planting Potatoes at Different Depths, Small Fruits, Onions, Peas, Sweet Corn, Carrots, Table Beets, Musk Melons, Watermelons, Squashes and Pumpkins, Salsify [and some other vegetables], Vegetable Lists, The Dandelion as a Market Crop, Boxes vs. Baskets for Market Gardeners, Cabbage. *Samuel B. Green.* Best Climatic Conditions for Grapes. *Charles Pomeroulie.*

MISSOURI :

6. Experiments on Seed Germination, Pea Weevil, and Apples. 1889. (No date). *J. W. Clark.*

NEBRASKA :

5. On Certain Injurious Insects of the Year 1888. Jan., 1889. *Lawrence Bruner.*
- (6.) Sweet Corn, Potatoes, Peas, Cucumbers, Tomatoes, Peppers, Beets, Onions, Carrots. Mar., 1889. *Jared G. Smith.*

NEW JERSEY :

- XLVI. Insect Pests and Means for Destroying Them. May, 1888.
George D. Hulst.
- L. Insects Injurious to the Cabbage and the Best Means of Preventing their Ravages. Dec., 1888. *George D. Hulst.*
63. Experiments on Tomatoes :
1. Consideration of Yields.
2. Consideration of Chemical Composition. Dec., 1889.
Edward B. Voorhees.
64. Some Fung[o]us Diseases of the Cranberry. Dec., 1889.
Byron D. Halsted.
- Special Bulletin, G. The Potato Rot. Aug., 1889. *Byron D. Halsted.*

NEW YORK :

- A. *Cornell University Experiment Station (Ithaca).*
- III. The Insectary of Cornell University, On Preventing the Ravages of Wire Worms, On the Destruction of the Plum Curculio by Poisons. Nov., 1888. *J. H. Comstock.*
- VII. On the Influences of Certain Conditions upon the Sprouting of Seeds. July, 1889. *L. H. Bailey.*
- IX. A Study of Windbreaks in their Relations to Fruit Growing. Sept., 1889. *L. H. Bailey.*
- X. Tomatoes. Oct., 1889. *L. H. Bailey.*
- XIV On the Strawberry Leaf-Blight, On Another Disease of the Strawberry. Dec., 1889. *W. R. Dudley.*
- (XV.) The Onion Mold, Anthracnose of Currants, Leaf-Blight of Quince and Pear. *W. R. Dudley.* The Apple-tree Tent Caterpillar. *J. H. Comstock.* The Orange Melon, The Candall Currant, Influence of Soil upon Peas, The Influence of Depth of Transplanting upon the Heading of Cabbages, Influence of Depth of Sowing upon Seed Tests, Do old Seeds of Cucurbits give Shorter Vines than Recent Seeds? Tests of a Patent Germinator. *L. H. Bailey.* Dec., 1889.
- B. *State Experiment Station (Geneva).*
11. Experiments in Cultivation, Experiment in Root Growth, Experiment with Fertilizers, Experiments with Insecticides, Experiments with Fungicides, Experiments with the Potato, Experiments with Sorghum. Sept., 1888. *E. S. Goff.*
15. Methods Adopted for the Systematic Testing of New Fruits, A Circular to the Originators or Proprietors of New Fruits, A List of Fruits now under Trial at the Station. Nov., 1888. *E. S. Goff.*
- (6th report.) A Test of Varieties of the Potato, with a Report of Experiments, Experiments in Root-Growth, Notes on Insecticides, Application for the Prevention of Apple Scab, A Study of the Movements of Soil Water, A Description of Varieties with Classification, List of Synonyms, and Bibliography of Various Vegetables. 1887. *E. S. Goff.*
- (7th Report.) The Orchard and Fruit Garden, Tests of Vegetable Novelties, The Station Arboretum, Experiments with Insec-

NEW YORK, (*State Exp. Sta.*), continued.

ticides, Experiments with Fungicides, The Potato—a test of Varieties and report of Experiments, The Influence of the Depth of Tillage upon the Depth of Roots, Experiments in the Cultivation of Corn, The Influence of Thorough as Contrasted with Slack Preparation of the Soil, Investigations in Soil Physics. 1888. *E. S. Goff*

- (8th report.) Report of the Acting Horticulturist: Strawberries, Raspberries, Currants, Blackberries, Gooseberries, Beans, Peas, Corn, Potatoes, Sweet Potatoes, Carrots, Tomatoes, Cabbages and Cauliflowers, Lettuce, Insects, Insecticides and Fungicides. *C. E. Hunn*. Report of the Acting Pomologist: Care and Improvement of the Orchard, Notes on Fruits, List of varieties at the Station, Spraying the Orchards with Insecticides, Spraying with Fungicides, Plums eaten by the Curculio, The Aphideæ—Spraying with Clear Kerosene and Emulsion, Seed Selection, with Notes on Vegetation. *G. W. Churchill*. Distr. 1890.

NORTH CAROLINA :

67. Seed Tests. Oct., 1889. *Gerald McCarthy*. [Bulletins 59 and 63 relate to seed tests of grasses and forage plants.]

OHIO :

2. Small Fruits and Vegetables. April, 1888. *W. J. Green*.
3. The Spring and Summer Treatment of Apple Orchards to Prevent Insect Injuries, Experiment with Remedies for the Plum Curculio. May, 1888. *C. M. Weed*.
- (4.) Experiments in Preventing Curculio Injury to Cherries. July, 1888. *C. M. Weed*.
5. Small Fruits. Aug., 1888. *W. J. Green*.
8. Practical Remedies for some Ohio Insects, Insecticides and their Application, Methods of Collecting, Preserving and Studying Insects. March, 1889. *C. M. Weed*.
11. Experiments with Small Fruits in 1889, Effect of Early and Late Picking upon Keeping Quality of Apples. July, 1889. *W. J. Green*.
13. Remedies for the Plum Curculio, Remedies for the Striped Cucumber Beetle, Strawberry Root-Louse and Grain Plant-Louse, Notes on Little Known Injurious Insects, Preventing the Injuries of Potato Rot. Sept., 1889. *C. M. Weed*.
14. Cabbage—Comparison of Varieties, Cauliflower—Comparison of Varieties, Puget Sound Cabbage and Cauliflower Seed, Notes on Experiments with Remedies for Certain Diseases. Nov., 1889. *W. J. Green*.
- (6th report.) Experiments with Potatoes, Experiments with Garden Vegetables, Experiments with Small Fruits. *W. J. Green*. Report of Seed Tests, Date of Blooming of Plants. 1887. [*Published 1888.*]
- (7th report.) Experiments with Strawberries, Experiments with Raspberries, Experiments with Blackberries, Summary of Small Fruit Experiments, Experiments with Potatoes. *W. J.*

OHIO, continued.

Green. Experiments with the Plum Curculio, Experiments with the Rose-bug, Insects Affecting the Currant and Gooseberry, Notes on some Raspberry Insects, Autumn Life History of Certain Plant Lice, Notes on Various Insects Affecting Garden Crops, Heat as a Remedy for Pea and Bean Weevils, On the Chinch-bug in Ohio, On two Potato Insects, The Spotted Grape-vine Beetle. *C. M. Weed*. 1888. [*Published 1889.*]

OREGON :

2. Horticultural,—Preparation and Notes on Future Work [and seed tests]. Jan., 1889. *E. R. Lake*.
- (3.) Practical Work with Insecticides. *E. R. Lake*. Corn Worm, Insecticides, Spraying Machines, Directions for Sending Insects. *F. L. Washburn*. Oct., 1889.

PENNSYLVANIA :

4. Seed Germinations. July, 1888. *George C. Butz*.
8. Systematic Testing of New Varieties, Germination Tests. July, 1889. *George C. Butz*.
- (1888 report.) Reports on Many Vegetables, Weeds, Grapes, Orchard Fruits, and Phenological Observations. *George C. Butz*.

RHODE ISLAND :

- (4.) Bee Keeping [some of the relations of bees to fruit and fruit-growing]. Dec., 1889. *Samuel Cashman*.
- (5.) Potatoes, Methods of Planting and Test of Varieties. Dec., 1889. *L. F. Kinney*.

SOUTH CAROLINA :

2. Tests of Commercial Seeds. May, 1888. *R. H. Loughridge*.
4. Entomology [Club-Root of Cabbage, and Many Insects]. Jan., 1889. *George F Atkinson*.
- (1st report.) Report of Botanist and Entomologist [accounts of plant diseases and many Carolina insects]. 1888 [*1889*]. *George F Atkinson*.

TENNESSEE :

2. Vol. II. Diseases of the Irish Potato. April, 1889. *F. Lamson Scribner*. [Issued also from the Cornell University Experiment Station.]
- (4. Vol. II.) Chemical Composition and Tests of Varieties of Strawberries. Oct., 1889. *W E. Stone*.

TEXAS :

- (2.) Report of Horticulturist [list of grapes]. May, 1888. *T L. Brunk*.
- (1st report.) Report of the Horticulturist [Grapes, Peach and Plum Rust, Fertilizers on Sweet Potatoes]. 1888. *T. L. Brunk*.

UNITED STATES : (Department of Agriculture.)

A. *Division of Pomology.*

Bulletin 1. Report on the Condition of Tropical and Semi-Tropical Fruits in the United States in 1887. 1888. *II. E. Van Deman*.

UNITED STATES (*Dept. of Agr., Div. of Pomology*), continued.

Bulletin 2. Report on the Adaptation of Russian and Other Fruits to the Extreme Northern Portions of the United States. 1888. *H. E. Van Deman.*

1887 report. The Apple, The Grape, The Peach, The Plum, The Orange, The Pomelo, The Kaki, The Olive, The Date, The Cranberry, Propagating Nut Trees. *H. E. Van Deman.* Peach Culture in the Extreme Southwest; Grape Culture. *G. Onderdonk.* 1888.

1888 report. Our Wild Fruits, The Apple, The Pear, The Plum, The Peach, The Dwarf Juneberry, The Pepino. *H. E. Van Deman.* Our Cultivated Fruits—Native and Introduced. *W. H. Ragan.* 1889.

B. Division of Botany. (Section of Vegetable Pathology.)

Bulletin 5. Report on the Experiments made in 1887 in the Treatment of the Downy Mildew and the Black Rot of the Grape Vine, with a Chapter on the Apparatus for Applying Remedies for these Diseases. 1888. *F. Lamson Scribner.*

Bulletin 7. Black Rot. 1888. *F. Lamson Scribner* and *Pierre Viala.* (Bulletin 8.) Gum Disease or Foot-rot of the Orange, Parasitic Fungi of Missouri, Extracts from Correspondence. 1889. *B. T. Galloway.*

Bulletin 9. Peach Yellows—A Preliminary Report. 1888. *Erwin F. Smith.*

Bulletin 10. Report on the Experiments made in 1888 in the Treatment of the Downy Mildew and Black Rot of the Grape Vine. 1889. *B. T. Galloway.*

Circular 3. Treatment of the Downy Mildew and Black Rot of the Grape. April, 1887. *F. Lamson Scribner.*

Circular 4. Treatment of the Potato and Tomato for the Blight and Rot. July, 1887. *F. Lamson Scribner.*

Circular 5. Fungicides, or Remedies for Plant Diseases. 1888. *F. Lamson Scribner.*

Circular 6. Treatment of Black Rot of the Grape. 1889? *B. T. Galloway.*

Circular 7. Grape Vine Diseases. 1889? *B. T. Galloway.*

Circular 8. Experiments in the Treatment of Pear Leaf-blight and the Apple Powdery Mildew. 1889. *B. T. Galloway.*

1887 report. Notes on Diseases of the Vine, Notes on the Treatment of Vine Diseases, Potato Blight and Rot, Field Observations and Experiments, Strawberry Leaf Blight, Apple Scab, Bitter-rot of Apples, The Rust of Beets, Leaf Rust of the Cherry, Peach, Plum, etc., Cotton-leaf Blight, Anthracnose of the Raspberry and Blackberry, Anthracnose of the Bean, Leaf-spot Disease of Catalpa, Black-spot on Rose Leaves, Rose Rust, The Rose Phragmidium, The Powdery Mildew of the Gooseberry, Smut of Indian Corn, Corn Rust, Erinose [of grapes]. 1888. *F. Lamson Scribner, and others.*

1888 report. Experiments in the Treatment of Grape Vine Diseases made in 1888, Necessity for More Extended Field Work, Downy Mildew of the Potato, Notes on the Black-rot of the Tomato,

UNITED STATES (*Dept. of Agr., Div. of Botany*), continued.

A Tomato Disease, Brown-rot of the Cherry, Powdery Mildew of the Cherry, Leaf-blight and Cracking of the Pear, Leaf-spot of the Rose, Plum Pockets, Apple Rusts, Septosporium on Grape Leaves, Leaf-spot Disease of the Maple, A Disease of the Sycamore, the Leaf-rust of Cottonwoods, Report on Peach Yellows, Additional Notes on Celery Leaf-blight. 1889. *B. T. Galloway, and others.*

C. *Division of Entomology.*

Bulletin 10. Our Shade Trees and their Insect Defoliators. 1887. *C. V. Riley.*

Bulletin 13. Report on Locusts in Texas in the Spring of 1886, Fourth Report on Insects injuring Forest and Shade Trees, Report on Nebraska Insects, Tests with Insecticides on Garden Insects, Report on Ohio Insects, A Record of some Experiments relating to the Effects of the Puncture of some Hemipterous Insects upon Shrubs, Fruits and Grains, 1886, Notes from Missouri for the season of 1886, Apicultural Experiments. 1887. *C. V. Riley.*

(Bulletin 14.) Reports of Observations and Experiments in the Practical Work of the Division [insects affecting cabbage, corn, tomato, egg-plant, pea, bean, squash, melon; also the relations of the curculio to the native plums by *D. B. Wier*]. 1887. *C. V. Riley.*

Bulletin 15. The *Icerya* or Fluted Scale, otherwise known as the Cottony Cushion-scale. 1887. *C. V. Riley and F. W. Morse.*

Bulletin 20. The Root-Knot Disease of the Peach, Orange and other Plants in Florida, due to the work of *Anguillula*. 1889. *J. C. Neal.*

(1887 report.) The Codlin Moth. *L. O. Howard.* Report on the Gas Treatment for Scale Insects. *D. W. Coquillett.* Report of Experiments against Scale Insects. *Albert Kabele.* [Various minor notes]. 1888.

(1888 report.) The Plum Curculio, The Fluted Scale, Report on Various Methods for Destroying Scale Insects (*D. W. Coquillett*) [various minor notes]. 1889. *C. V. Riley and others.*

D. *Division of Economic Ornithology and Mammalogy.*

Bulletin 1. The English Sparrow in North America, especially in its Relation to Agriculture. 1889. *Walter B. Barrows.*

1887 report. Food of Hawks and Owls, Experiments in Poisoning, Notes on the Depredations of Blackbirds and Gophers in Iowa and Southern Minnesota. *A. K. Fisher.* Some of the Results of a Trip through Minnesota and Dakota. *Vernon Bailey.* 1888.

1888 report. Notes upon various Birds and Mammals. 1889. *C. Hart Merriam.*

E. *Office of Experiment Stations.*

Experiment Station Bulletin 1. Organization of the Agricultural Experiment Stations in the United States. Feb., 1889. *W. O. Atwater.*

UNITED STATES (*Dept. of Agr., Office of Ex. Sta.*), continued.

- Experiment Station Bulletin 2. Digest of the Annual Reports of the Agricultural Experiment Stations in the United States for 1888. Part I. June, 1889. *W. O. Atwater.*
- Experiment Station Bulletin 3. Report of a Meeting of Horticulturists of the Agricultural Experiment Stations, at Columbus, Ohio, June 13, 14, 1889. July, 1889. *A. W. Harris.*
- Experiment Station Bulletin 4. List of Horticulturists of the Agricultural Experiment Stations in the United States, with an Outline of the Work in Horticulture at the Several Stations. Nov., 1889. *W. B. Atwood.*
- Farmers' Bulletin 1. The What and Why of Agricultural Experiment Stations. June, 1889. *W. O. Atwater.*
- Circular 1. List of Agricultural Experiment Stations in the United States, with addresses. Feb., 1889.
- Circular 6. List of Originators of Fruits, Vegetables, etc., in the United States. Mar., 1889. *W. O. Atwater.*
- Circular 11. Rules for Naming Vegetables, Report of Committee of Experiment Station Horticulturists. Sept., 1889. *W. O. Atwater.*
- Experiment Station Record, Vol. I, No. 1. Abstracts of Station Bulletins, Jan.—June, 1889. Part I. Sept., 1889. *W. O. Atwater.*

VERMONT :

- (9.) Insecticides. April, 1888. *W. W. Cooke.*
11. Coöperation in the Study of Insects. June, 1888. *G. H. Perkins.*
- (12.) Insecticides [analysis of], Seed Tests. Aug., 1888.
- (13.) Methods of Cutting and Planting Potatoes. Nov., 1888.
- (2d report.) Comparative Tests of Vegetables, Fruits, Potato Blight, Insecticides used in Orchard and Field, Seed Tests. *C. W. Minott.* June-bug, Leaf-roller, Apple Twig Borer, Apple Maggot. *G. H. Perkins.* Methods of Planting Potatoes, Methods of Cutting and Planting Potatoes. 1888 [1889].

VIRGINIA :

2. Experiment Orchard, Small Fruits. Oct., 1889. *Wm. B. Atwood.*

WISCONSIN :

- (13.) The Station Vineyard. Feb., 1888. *W. A. Henry.*
- (17.) Grape Growing. Nov., 1888. *W. A. Henry.*
- (5th report.) The Station Vineyard. 1888. *W. A. Henry.*

§ 2. SUBJECT INDEX OF THE MOST IMPORTANT HORTICULTURAL MATTERS.

Explanation.—Numbers standing alone refer to the number of a bulletin. Those preceded by p. refer to pages of reports.

APPLE, CULTURE AND VARIETIES—

Ala. Canebr. 2. Can. Agr. Coll. 15. Can. Exp. Farm, 1887 rep. p. 54; 1888 rep. p. 76. Colo. 1st rep. pp. 72 and 87. Fla. 1. Ia. 3. Ky. 18. Mass., Hatch, 1 and 2. Mich. 31 and 55. Minn. 1, 2; 1888 rep. p. 71. Mo. 6. N. Y. State, 6th rep. p. 340; 8th rep. p. 337, 339. Ohio, 11. U. S. Dep. Agr. Pomol. Div. 2; 1887 rep. p. 628; 1888 rep. pp. 570 and 578.

APPLE, DISEASES AND INSECTS OF—

Aphis, Can. Exp. Farm, 1887 rep. p. 27. *Bitter-rot*, U. S. Dep. Agr. 1887 rep. p. 348. *Blight*, Ia. 3. *Codlin Moth*, Ark. 3. Can. Exp. Farm, 1887 rep. p. 24. Colo. 6. Del. 4. Ia. 5 and 7. Kans. 1st rep. p. 165. Maine 1888 rep. p. 172. Mich. 31. N. Y. State, 7th rep. p. 146; 8th rep. p. 358. Ohio, 2 and 8. S. C. 1st rep. p. 31. U. S. Dep. Agr. 1887 rep. Ent. Div. p. 88. *Flea-Beetle*, Kans. 1st rep. p. 205. Nebr. 5. *Leaf-Hopper*, Ohio, 13. *Leaf-Beetle*, Colo. 6. Nebr. 5. *Leaf-Rust*, Ark. 1st rep. p. 127. *Maggot*, Vt. 2nd rep. p. 134. Maine, 2; 1888 rep. p. 175. *Plant-Louse*, Maine, 1888 rep. p. 170. *Powdery Mildew*, U. S. Dept. Agr. Bot. Div. Circ. 8. *Rust*, U. S. Dept. Agr. 1888 rep. p. 370. *Scab*, Del. 3. Maine 1888 rep. p. 149. N. Y. State, 7th rep. p. 156. U. S. Dept. Agr. 1888 rep. p. 341. *Tent Caterpillar*, Can. Exp. Farm, 1887 rep. p. 29. N. Y. Cornell, 15. S. C. 1st rep. p. 31. Vt. 11. Maine, 1888 rep. p. 159. *Tree Bark-Louse*, Can. Exp. Farm, 1887 rep. p. 30. Ohio, 3. *Tree-Borer*, Ia. 5. Kans. 3. Maine, 1888 rep. p. 153. Ohio 3 and 8. *Twig-Borer*, Kans. 1st rep. p. 209. Nebr. 5. U. S. Dept. Agr. 1888 rep. p. 137. *Twig-Blight*, Colo. 1st rep. p. 64.

APPLE, MISCELLANEOUS—

Analyses, Ia. 3 and 4.

APRICOT—

Can. Exp. Farm, 1887 rep. p. 55. N. Y. State, 8th rep. p. 338, 340. U. S. Dept. Agr. Pomol. Div. 2.

ASPARAGUS, CULTURE AND VARIETIES—

Fla. 1.

ASPARAGUS, DISEASES AND INSECTS OF—

Beetle, Del. 3. N. J. 46.

BAG-WORM—

S. C. 1st rep. p. 33.

BEAN, CULTURE AND VARIETIES—

Ala. 7. Ala. Canebr. 1. Ark. 2nd rep. p. 98. Colo. 2; 1st rep. p. 138. Dak. 5. Mass. Hatch, 4. N. Y. State, 6th rep. p. 332; 7th rep. p. 110; 8th rep. pp. 313, 364. Pa. 1888 rep. p. 137. Vt. 2nd rep. p. 102.

BEAN, DISEASES AND INSECTS OF—

Anthracnose, U. S. Dept. Agr. 1887 rep. p. 361. *Bean Cut-Worm*, U. S. Dept. Agr. Ent. Div. 14. *Weevil*, Can. Exp. Farm, 1888, rep. p. 55. Ohio, 7th rep. p. 163.

BEET, CULTURE AND VARIETIES—

Ala. Canebr.; 1. Can. Exp. Farm, 2. Colo. 2. Nebr. 6. N. Y. State, 6th rep. p. 120; 7th rep. p. 117.

BLACKBERRY, CULTURE AND VARIETIES—

Can. Exp. Farm, 1887 rep. p. 56. Mass. Hatch, 2. Mich. 55. Minn. 3. N. Y. State, 6th rep. p. 337; 8th rep. p. 311. Ohio, 2 and 5; 6th rep. p. 257; 7th rep. p. 114. U. S. Dept. Agr. Pomol. Div. 2; 1888 rep. p. 590.

BLACK KNOT—

Mass. Hatch, 6.

CABBAGE, CULTURE AND VARIETIES—

Ala. 2. Ala. Canebr. 6. Can. Exp. Farm, 2. Colo. 1st rep. p. 126. Dak. 5. Minn. 5; 1888 rep. p. 266. N. Y. Cornell 15. N. Y. State, 6th rep. p. 326; 7th rep. p. 118; 8th rep. p. 331. Ohio, 14; 6th rep. p. 211. Pa. 1888 rep. p. 143.

CABBAGE, DISEASES AND INSECTS OF—

Aphis, Colo. 6. Dak. 13. U. S. Dept. Agr. Ent. Div. 14. *Bug*, Ga. 2 and 3. *Butterfly*, Can. Exp. Farm, 1887 rep. p. 21; 1888 rep. p. 69. Colo. 6. Del. 4. Ia. 5. N. J. 46 and 50. S. C. 1st rep. p. 34. *Club-root*, Can. Exp. Farm, 1888 rep. p. 69. N. J. 50. S. C. 1st rep. p. 15. *Curculio*, U. S. Dept. Agr. 1888 rep. p. 136. *Plant-Louse*, N. J. 50. *Maggot*, Can. Exp. Farm, 1887 rep. p. 22. N. J. 46 and 50. *Plusia*, Dak. 13. N. J. 50. U. S. Dept. Agr. Ent. Div. 14. *Plutella*, U. S. Dept. Agr. Ent. Div. 14.

CANKER-WORM—

Maine, 1888 rep. p. 166. N. J. 46. Ohio, 8.

CARROT, CULTURE AND VARIETIES—

Can. Exp. Farm, 2. Colo. 2; 1st rep. p. 145. Dak. 5. Mass. State, 6th rep. p. 148. Minn. 1888 rep. p. 245. Nebr. 6. N. Y. State, 6th rep. pp. 133 and 318; 8th rep. p. 326. Ohio, 6th rep. p. 224. Pa. 1888 rep. p. 142.

CARROT, DISEASES AND INSECTS OF—

Fly, Can. Exp. Farm, 1887 rep. p. 21.

CAULIFLOWER, CULTURE AND VARIETIES—

Ark. 2nd rep. p. 103. Colo. 1st rep. p. 131. Dak. 5. Fla. 1. N. Y. State, 7th rep. p. 119; 8th rep. p. 331. Ohio, 14. Pa. 1888 rep. p. 144.

CELERY, CULTURE AND VARIETIES—

Ark. 2nd rep. p. 103. Fla. 1. N. Y. State, 6th rep. p. 215.

CELERY, DISEASES AND INSECTS OF—

Leaf-Blight, U. S. Dept. Agr. 1888 rep. p. 398.

CHERRY, CULTURE AND VARIETIES—

Can. Exp. Farm, 1887 rep. p. 55; 1888 rep. p. 84. Dak. 4. Ia. 2.
Mass. Hatch, 2. Mich. 55. U. S. Dept. Agr. Pomol. Div. 2.

CHERRY, DISEASES AND INSECTS OF—

Brown-Rot, Ohio, 14. U. S. Dept. Agr. 1888 rep. p. 349. *Leaf-rust*,
U. S. Dept. Agr. 1887 rep. p. 353. *Powdery Mildew*, U. S. Dept.
Agr. 1888 rep. p. 352. *Slug*, Ohio, 13. *Tree Plant-Louse*, Maine,
1888 rep. p. 181.

CORN, SWEET—

Ala. 1 and 3. Colo. 1st rep. p. 150. Dak. 5. Fla. 2. Ill. 6. Ind.
18. Ia. 2. Kans. 1st rep. p. 317. Minn. 1888 rep. p. 243. Nebr.
6. N. Y. State, 7th rep. p. 119; 8th rep. p. 320. Ohio, 6th rep.
p. 243. Pa. 1888 rep. p. 145.

CORN, DISEASES AND INSECTS OF—

Root-Worm, Ia. 4. Nebr. 5. *Rot*, Ill. 6. *Rust*, U. S. Dept. Agr. 1887
rep. p. 389. *Worm*, Oregon, 3. U. S. Dept. Agr. Ent. Div. 14.

CRANBERRY, CULTURE AND VARIETIES—

U. S. Dept. Agr. Pomol. Div. 2; 1887 rep. p. 646; 1888 rep. p. 591.

CRANBERRY, DISEASES AND INSECTS OF—

N. J. 64.

CUCUMBER, CULTURE AND VARIETIES—

Colo. 1st rep. p. 147. Fla. 7. Nebr. 6. N. Y. Cornell, 15. N. Y.
State, 6th rep. pp. 231 and 322; 7th rep. p. 121. Pa. 1888 rep. p.
144. Vt. 2nd rep. p. 107.

CUCUMBER, DISEASES AND INSECTS OF—

Ind. 19. N. Y. State, 6th rep. p. 316. *Beetle*, Dak. 13. Del. 4.
Ia. 5. Ohio, 8 and 13.

CURRANT, CULTURE AND VARIETIES—

Can. Exp. Farm, 1887 rep. p. 56. Mich. 55. Minn. 3. N. Y. Cor-
nell, 15. N. Y. State, 6th rep. p. 338; 8th rep. p. 311. U. S.
Dept. Agr. Pomol. Div. 2; 1888 rep. p. 590.

CURRANT, DISEASES AND INSECTS OF—

Anthraxnose, N. Y. Cornell, 15. *Bark-Louse*, Can. Exp. Farm, 1887 rep.
p. 37. *Borer*, Colo. 6. Ohio, 6. *Currant-Worm*, Del. 4. Maine,
1888 rep. p. 182. Mass. Hatch, 2. Ohio, 8 and 13. *Measuring-*
Worm, Colo. 6.

CUT-WORM—

Can. Exp. Farm, 1888 rep. p. 71. Dak. 13. Ia. 5. Nebr. 5. N. J.
50.

DATE—

U. S. Dept. Agr. 1887 rep. p. 646.

EGG-PLANT—

Ala. 2. Colo. 1st rep. p. 136. N. Y. State, 6th rep. p. 273. U. S. Dept. Agr. Ent. Div. 14 (*Aphis*).

GOOSEBERRY—

Can. Exp. Farm, 1887 rep. p. 56. Mich. 55. Minn. 3. N. Y. State, 6th rep. p. 338; 8th rep. p. 312. Ohio, 11. U. S. Dept. Agr. 1888 rep. p. 591.

GOOSEBERRY, DISEASES AND INSECTS OF—

Powdery Mildew, U. S. Dept. Agr. 1887 rep. p. 373.

GRAPE, CULTURE AND VARIETIES—

Ala. 1, 3 and 4. Ala. Canebr. 6. Ark. 7. Can. Agr. Coll. 8. Can. Exp. Farm, 1887 rep. p. 56. Ia. 7. Mass. Hatch, 1 and 2. Mich. 55. Minn. 1888 rep. pp. 218 and 297. N. Y. State, 6th rep. p. 341; 8th rep. p. 340. Pa. 1888 rep. p. 158. Tex. 1st rep. p. 36. U. S. Dept. Agr. Pomol. Div. 2; 1887 rep. p. 632; 1888 rep. p. 586. Wis. 13 and 17; 5th rep. p. 157.

GRAPE, DISEASES AND INSECTS OF—

Bitter Rot, U. S. Dept. Agr. 1887 rep. p. 324; Circ. 7, Bot. Div. *Black Rot*, Del. 3 and 6. Ia. 3. Ohio, 14. U. S. Dept. Agr. Bot. Div. 5, 7, 10; Circ. 3 and 6, Bot. Div.; 1887 rep. p. 326; 1888 rep. 334. *Flea-Beetle*, Nebr. 2. *Leaf-Folder*, Ark. 1st rep. p. 122. *Leaf-Hopper*, Can. Exp. Farm, 1887 rep. p. 34. Mass. Hatch, 2. *Mildew*, Del. 3. U. S. Dept. Agr. Bot. Div. 5 and 10; Circ. 3 and 7; 1887 rep. p. 328; 1888 rep. p. 326. *Saw-Fly*, S. C. 1st rep. p. 38. *Scale*, U. S. Dept. Agr. 1888 rep. p. 135. *Septosporium*, U. S. Dept. Agr. 1888 rep. p. 381. *Vine Leaf-Roller*, S. C. 1st rep. p. 37. *Vine-Looper*, Can. Exp. Farm, 1887 rep. p. 35. *White-Rot*, U. S. Dept. Agr. 1887 rep. p. 325.

GREENHOUSE—

Heating, Mass. Hatch, 4 and 6. *Walls*, Mass. Hatch, 4. Minn. 7.

INSECTICIDES—

Ark. 10. Cal. 79. Colo. 6. Dak. 13. Fla. 4. Ia. 5. Kans. 1st rep. p. 165. Maine, 1888 rep. p. 189. Mass. Hatch. 2 and 4. Mich. 39 and 53. Minn. 1888 rep. p. 203. N. J. 46. N. Y. State, 11; 6th rep. p. 96; 7th rep. pp. 144 and 228; 8th rep. p. 333, 358, 362. Ohio, 3 and 8; 7th rep. p. 163. Oregon, 3. Vt. 9 and 12; 2nd rep. pp. 69 and 122. U. S. Dept. Agr. Ent. Div. 13.

JUNEBERRY—

U. S. Dept. Agr. Pomol. Div. 2.

KAKI, OR JAPANESE PERSIMMON—

U. S. Dept. Agr. 1887 rep. p. 642

KALE—

Mich. 48.

LETTUCE, CULTURE AND VARIETIES—

Ala. Canebr. 1. Dak. 5. N. Y. State, 6th rep. p. 326; 7th rep. p. 122; 8th rep. p. 333. Pa. 1888. rep. p. 146.

LETTUCE, DISEASES AND INSECTS OF—

Mildew, Mass. Hatch, 4. *Worm*, Ohio, 7th rep. p. 166.

MELON, MUSK—

Ala. 3. Ala. Canebr. 2 and 6. Colo. 1st rep. p. 142. Fla. 2. Minn. 1888 rep. p. 249. N. Y. Cornell, 15. N. Y. State, 6th rep. p. 318; 7th rep. p. 123. Vt. 2nd rep. p. 108.

MELON, WATER—

Ala. 2. Fla. 2. Minn. 1888 rep. p. 251. N. Y. Cornell, 15. N. Y. State, 6th rep. p. 318; 7th rep. p. 127. Vt. 2; 2nd rep. p. 108.

MELON, DISEASES AND INSECTS OF—

Borer, U. S. Dept. Agr. Ent. Div. 14. *Melon Plant-Louse*, U. S. Dept. Agr. Ent. Div. 14. *Worm*, Ga. 3.

MULBERRY—

Mich. 55. U. S. Dept. Agr. Pomol. Div. 2.

NUTS—

Mich. 55.

OLIVE—

U. S. Dept. Agr. 1887 rep. p. 645.

ONION, CULTURE AND VARIETIES—

Can. Exp. Farm, 2. Colo. 1st rep. p. 118. Dak. 5. Fla. 2. Ind. 18. Mich. 31. Minn. 1888 rep. pp. 225 and 236. Nebr. 6. N. Y. State, 6th rep. pp. 190 and 318; 8th rep. p. 330. Ohio, 6th rep. p. 229.

ONION, DISEASES AND INSECTS OF—

Maggot, Can. Exp. Farm, 1887 rep. p. 23. *Mold*, N. Y. Cornell, 15.

ORANGE—

Fla. 1 and 2. U. S. Dept. Agr. 1887 rep. p. 637.

ORANGE, DISEASES AND INSECTS OF—

Foot-Rot, U. S. Dept. Agr. Ent. Div. 8. *Root-Knot*, U. S. Dept. Agr. Ent. Div. 20. *Scale*, U. S. Dept. Agr. Ent. Div. 15.

PARSNIP—

Can. Exp. Farm, 2.

PEA, CULTURE AND VARIETIES—

Ala. 1, 3 and 7. Ala. Canebr. 1 and 6. Ark. 2nd rep. p. 97. Can. Exp. Farm, 2. Colo. 1st rep. p. 122. Dak. 5. Ind. 18. Kans. 1st rep. p. 256. La. 16. Maine, 24; 1888 rep. p. 129. Minn. 1888 rep. p. 230. Nebr. 6. N. Y. Cornell, 15. N. Y. State, 6th rep. p. 330; 7th rep. p. 131; 8th rep. p. 318. Ohio, 2; 6th rep. p. 236. Pa. 1888 rep. p. 146. Vt. 2nd rep. p. 107.

PEA, DISEASES AND INSECTS OF—

Weevil, Can. Exp. Farm, 1888 rep. p. 56. Colo. 6. Mo. 6.

PEACH, CULTURE AND VARIETIES—

Ala. Canebr. 2. Can. Exp. Farm, 1888 rep. p. 55. Fla. 1 and 4. Mass. Hatch, 1 and 2. Mich. 55. N. Y. State, 8th rep. p. 338 and 340. U. S. Dept. Agr. 1887 rep. p. 634; 1888 rep. p. 574 and 580.

PEACH, DISEASES AND INSECTS OF—

Borer, Ark. 3. Fla. 2. S. C. 1st rep. p. 37. *Curculio* (See under Plum). *Leaf-Curl*, Del. 3. *Root-Knot*, Ala. 9. Fla. 2. U. S. Dept. Agr. Ent. Div. 20. *Rust*, Tex. 1st rep. p. 39. *Spotting*, Ind. 19. *Yellowows*, Del. 3. N. Y. State, 5th rep. p. 135. U. S. Dept. Agr. Bot. Div. 9; 1888 rep. p. 393.

PEAR, CULTURE AND VARIETIES—

Ala. 3. Can. Exp. Farm, 1887 rep. p. 55; 1888 rep. p. 82. Colo. 1st rep. p. 92. Dak. 4. Fla. 1. Ia. 3. Mass. Hatch, 2. Mich. 55. Minn. 3. N. Y. State, 8th rep. p. 338. U. S. Dept. Agr. Pomol. Div. 2; 1888 rep. pp. 572 and 579.

PEAR, DISEASES AND INSECTS OF—

Blight, N. Y. State. 2. *Blight Beetle*, Can. Exp. Farm, 1887 rep. p. 31. *Codlin Moth* (see under Apple). *Leaf-Blight*, N. Y. Cornell Exp. Sta. 15. U. S. Dept. Agr. 1888 rep. p. 357; Circ. Bot. Div. 8. *Slug*, Colo. 6. Maine, 1888 rep. p. 176.

PEPPER—

Colo. 1st rep. p. 136. Mich. 31. Nebr. 6.

PERSIMMON, JAPANESE, OR KAKI—

U. S. Dept. Agr. 1887 rep. p. 642.

PLUM, CULTURE AND VARIETIES—

Ala. 3. Can. Exp. Farm, 1887 rep. p. 55; 1888 rep. p. 3. Fla. 81. Ia. 4. Mass. Hatch, 2. Mich. 55. Minn. 5. U. S. Dept. Agr. Pomol. Div. 2; 1887 rep. p. 634; 1888 rep. pp. 573 and 585.

PLUM, DISEASES AND INSECTS OF—

Curculio, Del. 4. Fla. 2. Ia. 5. Ind. 25. Maine, 1888 rep. p. 178. Mich. 39 and 53; Rep. Bd. Agr. 1887, 40. N. Y. Cornell, 3. N. Y. State, 8th rep. p. 358. Ohio, 3, 4, 6, 8 and 13; 7th rep. p. 134. U. S. Dept. Agr. Ent. Div. 14; 1888 rep. p. 57. *Leaf-Fungus*, N. Y. State, 5th rep. p. 293; 6th rep. p. 347. *Pockets*, U. S. Dept. Agr. 1888 rep. p. 366. *Rust*, Tex. 1st rep. p. 38. *Wart or Knot*, Mass. Hatch, 6.

POMELO—

U. S. Dept. Agr. 1887 rep. p. 642.

POTATO, CULTURE AND VARIETIES—

Ala. 1 and 7. Ala. Canebr. 1, 2 and 6. Ark. 1st rep. p. 59; 2nd rep. p. 27. Can. Exp. Farm, 2. Colo. 4 and 7; 1st rep. p. 100. Fla. 1. Ind. 15 and 18. Kans. 1st rep. p. 226. Ky. 16 and 22. La. 11 and 16. Md. 2. Maine 24; 1888 rep. p. 123. Mass. Hatch, 4. Mass. State, 6th rep. p. 121. Mich. 31 and 48. Minn. 1, 5, and 7; 1888 rep. pp. 82 and 230. Nebr. 6. N. Y. State, 11; 6th rep. p. 26 and 76; 7th rep. p. 158; 8th rep. p. 321. Ohio, 2; 6th rep. p. 196; 7th rep. p. 116. Pa. 1888 rep. p. 41. R. I. 5. Vt. 13; 2nd rep. p. 93 and 110. Wis. 13 and 17.

POTATO, DISEASES AND INSECTS OF—

Beetle, Can. Exp. Farm, 1888 rep. p. 67. Dak. 13. Del. 4. Ohio, 8. S. C. 1st rep. p. 40. *Rot*, Ia. 3. Mass. Hatch, 6. Ohio, 13. Tenn. 2 Vol. II. Vt. 2nd rep. p. 121. U. S. Dept. Agr. Bot. Div. Circular 4; 1887 rep. p. 331; 1888 rep. p. 337. *Scab*, Maine 1888 rep. p. 148. Mass. State, 6th rep. p. 307; 7th rep. p. 224.

PUMPKIN—

Ark. 2nd rep. p. 104. Minn. 1888 rep. p. 253. N. Y. State, 6th rep. p. 243. Vt. 2nd rep. p. 114.

QUINCE—

Mich. 55.

QUINCE, DISEASES AND INSECTS OF—

Curculio, N. Y. State, 6th rep. p. 315. *Leaf-Blight*, N. Y. Cornell, 15. Ohio, 14.

RADISH—

Ala. Canebr. 6. Ark. 2nd rep. p. 101. Can. Exp. Farm, 2. Mich. 40. N. Y. State, 6th rep. p. 146. Ohio 6th rep. p. 227. Pa. 1888 rep. p. 149.

RASPBERRY CULTURE AND VARIETIES—

Ala. 1, 2 and 4. Can. Agr. Coll. 27. Can. Exp. Farm, 1888 rep. p. 56. Mass. Hatch, 2. Mich. 55. Minn. 3. N. Y. State, 6th rep. p. 335; 7th rep. p. 231; 8th rep. p. 308. Ohio, 2 and 5; 6th rep. p. 253; 7th rep. p. 111. U. S. Dept. Agr. Pomol. Div. 2; 1888 p. 589.

RASPBERRY, DISEASES AND INSECTS OF—

Anthracoise, U. S. Dept. Agr. 1887 rep. p. 357. *Borer*, Ohio 11. *Saw-fly*, Colo. 6. Ohio, 8.

RHUBARB—

Fla. 1. Ohio, 13.

ROOT-KNOT OR GALLS—

Ala. 9. Fla. 2. U. S. Dept. Agr. Ent. Div. 20.

ROSE, DISEASES AND INSECTS OF—

Black-Spot, Mass. 6. *Leaf-Blight*, Mass. Hatch, 4. *Leaf-Hopper*, Ohio, 13. *Leaf-Spot*, U. S. Dept. Agr. 1887 rep. p. 366; 1888 rep. p. 364. *Mildew*, Mass. Hatch, 4. *Rust*, U. S. Dept. Agr. 1887 rep. p. 369.

ROSE-BEETLE OR ROSE-CHAFFER—

Del. 4. Ohio, 7th rep. p. 150.

SEEDS, GERMINATION AND TESTING OF—

Ark. 2nd rep. p. 92. Can. Exp. Farm, 2. Dak. 4. Del. 5. Kans. 1st rep. p. 337. Maine, 1888 rep. p. 136. Mich. 31 and 40. Mo. 6. N. C. 63 and 67. N. Y. Cornell, 7 and 15. N. Y. State, 6th rep. p. 39. Ohio, 6th rep. p. 283. Oregon, 2. Penn. 4 and 8. S. C. 2; 1st rep. p. 58. Vt. 12; 2nd rep. p. 122.

SPINACH—

N. Y. State, 6th rep. p. 325.

SQUASH, CULTURE AND VARIETIES—

Ark. 2nd rep. p. 104. Mich. 48. Minn. 1888 rep. p. 253. N. Y. Cornell, 15. N. Y. State, 6th rep. pp. 243 and 323. Vt. 2nd rep. p. 115.

SQUASH, DISEASES AND INSECTS OF—

Borer, U. S. Dept. Agr. Ent. Div. 14. *Bug*, Colo. 6. S. C. 1st rep. p. 26. U. S. Dept. Agr. Ent. Div. 14.

STRAWBERRY, CULTURE AND VARIETIES—

Ala. 1 and 4. Ark. 7 and 11; 2nd rep. p. 82. Can. Agr. Coll. 37. Can. Exp. Farm, 5. Fla. 2. Mass. Hatch, 2 and 6. Mich. 31 and 55. Minn. 3. N. Y. State, 7th rep. p. 229; 8th rep. p. 298. Ohio, 2, 5 and 11; 6th rep. p. 245; 7th rep. p. 103. Tenn. 4. Vol. II. U. S. Dept. Agr. 1888 rep. p. 588.

STRAWBERRY, DISEASES AND INSECTS OF—

Blight, Del. 3. N. Y. Cornell, 14. U. S. Dept. Agr. 1887 rep. p. 334. *Mildew*, N. Y. State, 6th rep. p. 333, *Root-Louse*, Ohio, 13. *Weevil*, Can. Exp. Farm, 1887 rep. p. 37.

SWEET POTATO—

Ala. 3. Ark. 2nd rep. p. 91. Ga. 2 and 3. N. Y. State, 8th rep. p. 326. Tex. 1st rep. p. 40.

TOMATO, CULTURE AND VARIETIES—

Ala. 2 and 7. Ala. Canabr. 2 and 6. Ark. 2nd rep. p. 100. Can. Exp. Farm, 2. Colo. 1st rep. p. 133. Dak. 5. Kans. 1st rep. p. 271. La. 16. Mich. 31 and 48. Nebr. 6. N. J. 63. N. Y. Cornell, 10. N. Y. State, 6th rep. pp. 279 and 328; 7th rep. p. 138; 8th rep. p. 327. Ohio, 2; 6th rep. p. 231. Pa. 1888 rep. p. 150.

TOMATO, DISEASES AND INSECTS OF—

Aphis, U. S. Dept. Agr. Ent. Div. 14. *Borer*, U. S. Dept. Agr. Ent. Div. 14. *Black-Rot*, U. S. Dept. Agr. 1888 rep. p. 339. *Blight*, U. S. Dept. Agr. Bot. Div. Circular 4; 1887 rep. p. 331; 1888 rep. p. 347. *Worm*, Del. 4. Mich. 42. U. S. Dept. Agr. Ent. Div. 14.

TURNIP, CULTURE AND VARIETIES—

Ala. 3. Can. Exp. Farm, 2. Mass. State, 6th rep. p. 139. N. Y. State, 6th rep. p. 168.

TURNIP, DISEASES AND INSECTS OF—

Aphis, Can. Exp. Farm, 1887 rep. p. 19. *Flea-Beetle*, Can. Exp. Farm, 1887 rep. p. 18. N. Y. State, rep. p. 150.

WINDBREAKS—

N. Y. Cornell, 9.

2. *Books of 1889, Exclusive of the Reports of Organizations.*

- Baker, J. G. Handbook of Bromeliaceæ. London.
 Barnard, Charles. My Handkerchief Garden. New York.
 Bois. Le Petit Jardin. Paris.
 Castle, L. Chrysanthemum Annual.
 Castle, L. Orchids. London (?).
 Crrevon. Les Fougères Rustiques. Geneva.
 Cranston, John. Cultural Directions for the Rose. 7th ed. London (?).
 Cultivato de los Rosales en Macetas. Madrid.
 Dyer, T. F. Thistleton. The Folk-Lore of Plants. New York (American edition).
 Ellwanger, George H. The Garden's Story; or, Pleasure and Trials of an Amateur Gardener. New York.
 Fitzgerald. Australian Orchids. Vol. II, part 3. Sydney.
 Flood. Garden Annual for 1890. London.
 Godefroy and Brown. Cyripédiées.
 Harkness, John. Practical Rose-Growing. Bradford, England.
 Jaeger, H. Gartenkunst und Gärten Sonst und Jetzt. Berlin.
 Knaggs, H. Valentine. Onions and Cress. London (?).
 Maiden, J. H. Useful Native Plants of Australia. London and Sydney.
 Nederlandse Orchidophilen Club. Catalogue of Orchids.
 Nicholson, George. The Illustrated Dictionary of Gardening. A Practical and Scientific Encyclopædia of Horticulture for Gardeners and Botanists. Vol. IV and Supplement. London and New York.
 Nutting, W. R. California Views in Natural Colors. San Francisco.
 Ormerod, Eleanor A. Report of Observations of Injurious Insects and Common Farm Pests During the Year 1888. London.
 Paul, William. The Rose Garden. 9th edition. London.
 Pax. Monographische Übersicht Über die Arten und der Gattung Primula.
 Petzold, E. Die Landschaftsgärtnerei. 2d edition. Leipzig.
 Robinson, W. English Flower Garden. 2d edition. London.
 Roe, E. P. The Home Acre. New York.
 Simkins, James. The Pansy and How to Grow It. London.
 Sweet, Alex. Villa and Cottage Gardening. London.
 Veitch and Sons, James. Manual of Orchidaceous Plants. Part IV, Cyripedium. Part V, Masdevallia and Allied Genera. London.
 Ward, H. Marshall. Diseases of Plants. London.
 Watson, W. Cactus Culture for Amateurs. London.
 Watson, W., and Bean, W. Orchids, their Culture and Management. Parts 1-7. London.
 Weeks & Co., John. Horticultural Pocket Book and Diary. Chelsea.
 Wickson, E. J. California Fruits and How to Grow Them. San Francisco.
 Wickson, E. J. The Vacaville Early Fruit District. San Francisco.
 Wilks, W., and Barron. British Apples. London.

3. *Horticultural Periodicals of the World.*

NORTH AMERICA.

This list includes all the periodicals which are strictly horticultural. Many agricultural papers publish horticultural departments, and a few, of which the *Florida Dispatch* and *Northwest Horticulturist*, *Agriculturist* and *Stockman* are examples, give particular attention to horticultural matters.

American Farm and Horticulturist. Lakewood, Ohio. *Quart.*
 American Florist. Chicago. *Semi-monthly*
 American Garden. New York. *M.*
 California Fruit Grower. San Francisco. *W.*
 Canadian Horticulturist. Grimsby, Ontario. *M.*
 Citrograph. Redlands, Cal.
 Floral Instructor. Ainsworth, Ia. *M.*
 Florists' Exchange. New York. *W.*
 Fruit and Grape Grower. Charlottesville, Va. *M.*
 Fruit and Vegetable Grower. Cheswold, Del. *M.*
 Fruit Growers' Journal. Cobden, Ill. *Semi-monthly.*
 Fruit Trade Journal, New York. *W.*
 Garden and Forest. New York. *W.*
 Green's Fruit Grower. Rochester. *Quart.*
 Horticultural Art Journal. Rochester. *M.*
 Journal of the Columbus Horticultural Society. Columbus, O. *Quart.*
 Mayflower. Queens, N. Y. *M.*
 Orchard and Garden. Little Silver, N. J. *M.*
 Park's Floral Magazine. Fannetsburg, Pa. *M.*
 Pilot Point Horticulturist. Pilot Point, Texas. *M.*
 Popular Gardening. Buffalo. *M.*
 Seed Time and Harvest. La Plume, Pa. *M.*
 Southern Horticultural Journal. Denison, Texas. *Semi-monthly.*
 Trade Journal and International Horticulturist. New York. *M.*
 Vick's Magazine. Rochester. *M.*
 Vineyardist. Penn Yan, N. Y. *Semi-monthly.*

ENGLAND.

Amateur Gardening. London.	Garden Horticultural Gazette. Manchester.
Botanical Magazine. London.	Gardener. London.
Floral Magazine. London.	Gardeners' Chronicle. London.
Floral World and Garden Guide. London.	Gardener's Magazine. London.
Florist and Pomologist. London.	Gardening Illustrated. London.
Fruit Farm Review.	Gardening World. London.
Fruit Trade Journal. London.	Horticultural Record. London.
Garden. London.	Horticultural Times. London.
Garden Almanack. London.	Journal of Horticulture. London.

IN FRENCH.

- Annales de l' Horticulture. Brussels.
Annuaire Général d' Horticulture. Toulouse.
Belgique Horticole (La). Gand (Ghent).
Bulletin d' Arboriculture. Ghent.
Bulletin d' Arboriculture, de Floriculture, et de Culture Potagère. Gand (Ghent).
Bulletin de la Fédération des Sociétés d' Horticulture de Belgique, publié par le Ministère de l' Agriculture. Gand.
Bulletin de l' Horticulture. Clermont (Oise).
Bulletin de la Société Horticole, Viticole et Forestière de Sens. Auxerre.
Bulletin de la Société d' Horticulture de Bongival. Saint-Germain-en-Laye.
Bulletin du Cercle Floral d' Anvers. Anvers.
Bulletin du Syndicat des Viticulteurs de France. Paris.
Bulletin Horticole (Le). Huy.
Bulletin Mensuel de la Société d' Horticulture Pratique du Rhone. Lyons.
Chasse et Pêche, Acclimation et Élevage. Organ of the Royal Society of St. Hubert. Brussels.
Flore des Serres et Jardins de l' Angleterre. Gand (Ghent).
Horticulteur, L' Mons.
Jardin (Le). Argenteuil.
Jardin de la France. Tours.
Journal d' Agriculture et d' Horticulture. Bordeaux.
Journal de Horticulture Pratique. Paris.
Journal de Vulgarisation de l' Horticulture. Paris.
Journal des Roses. Paris.
Illustration Horticole, L'. Brussels.
Lindenia, Iconographie des Orchidées. Brussels.
Orchidophile, L'. Argenteuil.
Lyon Horticole. Lyons.
Moniteur d' Horticulture, Arboriculture, Viticulture, Sciences, Arts et Industries Horticoles. Paris.
Revue de l' Horticulture Belge et Étrangère. Ghent.
Revue Horticole. Paris.
Revue Horticole, Viticole, et Apicole de la Suisse Romande. Geneva.

IN GERMAN.

- Berliner Blätter für Botanik, Gärtnerei und Landwirthschaft. Berlin.
Deutsche Gärten-Zeitung. Leipzig.
Deutscher Garten. Berlin.
Deutscher Garten-Kalendar. Berlin.
Deutsches Magazin für Garten-und Blumenkunde. Stuttgart.
Freyhoff's Garten und Ackerbau-Zeitung. Oranienburg.
Gärtner. Berlin.
Garten-und Blumenfreund. Cassel.
Garten-und Blumenzeitung. Hamburg.
Gartenflora. Berlin.
Hamburger Garten-und Blumen-Zeitung. Hamburg.
Illustrierte Monatshefte für des Gesamt-Interessen des Gartenbaues. Munich.

HORTICULTURAL PUBLICATIONS (*in German*), continued.

- Illustrierte Garten-Zeitung. Stuttgart.
 Monatsblatt für Gartenbau. Kiel.
 Monatsschrift des Gartenbauvereins zu Darmstadt. Darmstadt.
 Monatsschrift für Obst und Weinbau. Frauenfeld.
 Nachrichten aus dem Gebiete des Gartenbaues, der Landwirthschaft, Fish-
 erei und Jagd. Vilshofen and Hacklberg.
 Obstbau. Stuttgart.
 Obstgarten. Klosterneuburg bei Wien (Vienna).
 Obstdeutscher Anzeiger für Gartenbau. Thorn.
 Pomologische Monatshefte. Stuttgart.
 Praktische Obstzüchter. Klosterneuburg bei Wein (Vienna).
 Practische Ratgeber im Obst-und Gartenbau. Frankfurt á. d. O.
 Rheinische Blätter für Obst-Wein-und Gartenbau. Strassburg.
 Rheinische Gartenschrift. Karlsruhe Vereinigte Frauendorfer Blatter.
 Frauendorf.
 Rosen-Zeitung. Frankfort-on-the-Main.
 Wiener Illustrierte Garten-Zeitung. Vienna. (Journal of the Imperial
 Horticultural Society.)
 Zeitschrift für Obst-und Gartenbau. Leipzig.

IN ITALIAN, SPANISH, PORTUGUESE.

- Bulletino della Societa Toscana d' Horticultura. Florence.
 Frutta e Vino. Milan.
 Giardini. Milan.
 Giardinere. Milan.
 Jornal de Horticultura Practica. Oporto.
 L' Orticoltura Genovese. Genoa.
 O' Floricultor. Oporto.
 Revista de Horticultura. Rio de Janiero.
 Revista Horticolgoica. Barcelona.
 Rivista Orticola. Pallanza.

MISCELLANEOUS.

- Dansk Havetidende. Copenhagen.
 Gyümölcsészeti és Konyhakertészeti Füzetek. Budapest.
 Het Neederlandsche Tuinboublad. Arnhem.
 Journal of the Board of Viticulture. Victoria, Australia.
 Kertészeti Füzetek. Budapest.
 Nép Kortésze. Budapest.
 Sadovodstvo. Moscow.
 Sempervirens; Gronewegen. Amsterdam.
 Tidning för Trädgordsodlare. Stockholm.

CHAPTER XI.

NECROLOGY OF 1889.



FIG. 50. ANDREW J. CAYWOOD.

ANDREW J. CAYWOOD.

BY W. C. CAYWOOD.

Andrew J. Caywood was borne in Orange County, New York, in August, 1819, and died at Marlboro, N. Y., Jan. 13th,

1889. He was the youngest of eight children. His father, who was a farmer, died when he was quite young. He continued at farming until 22 or 23 years of age, when feeling the need of a better education than his former opportunities had afforded, he attended the Amenia (N. Y.) Seminary for two years, making special studies of botany and geology. At 27 years of age he married and bought a small farm in Ulster county and began the fruit and nursery business. He planted the first vineyards and peach orchards for market purposes in Ulster county, and by his enthusiasm induced neighbors to do likewise; and principally through his efforts, Ulster county is now the foremost fruit producing section in the east. At the same time he commenced the crossing of fruits and planting the seeds, with a view of improving on existing varieties, and to this branch he devoted most of his energy and means for the balance of his life, each year having thousands of seedlings to discard after cultivating and watching them for from three to six years. From the first planting of the seed he was thirty years in producing the Marlboro raspberry by crossing and re-crossing the seedlings of six generations.

The named fruits he has originated are the Walter, Modena, Hudson, Duchess, Lily, Ulster, Poughkeepsie, White Concord, Nectar and Metternich grapes; Cetywayo and Mammoth Bush strawberries, Marlboro and Crystal raspberries, and Minnewaska blackberry, besides some eighty varieties of grapes, raspberries, currants, pears, cherries, etc., which are numbered, many of which give promise of much value. He always selected the best of native varieties for his experiments, never intermixing any foreign blood, as he believed that only pure natives could withstand the diversities of our climate. All of the fruits he has disseminated are the best of their class, and although he did not accumulate riches, he has left something which will last longer, and keep him in memory of all who enjoy one of nature's best gifts—good fruit.

He was a contributor to the horticultural press for years, and was a member of the American Pomological Society, and all other leading horticultural societies of the country, and from its foundation, of the Poughkeepsie Scientific Society, now Vassar Bros. Institute.

JOHN HENDERSON.

After a long and painful illness John Henderson passed away on Tuesday, December 17, the immediate cause of death being heart failure. With him horticulture loses one of its noblest representatives, loved and honored by all who enjoyed the privilege of his friendship as a Christian and a gentleman.

Mr. Henderson was born in London, England, December 5, 1818, where he received a classical education, taking a prize in Greek scholarship at the age of 15. He came to America in 1856, and settled in Flushing, on Long Island, which continued to be his home until 1888. He soon became an authority in horticulture, making a specialty of roses. He delivered the first horticultural lecture ever given in the Cooper Institute, for which he received a silver medal. He was a life member of the New York Horticultural Society and the American Institute, constantly officiating as judge at the exhibitions of both bodies, and was also prominent in the Society of American Florists and Nurserymen's Association. He retired from active business last year, taking a long trip to the Pacific Coast for the benefit of his health, which was far from robust at the time. On his return he removed to Brooklyn, where he resided until his death.

During his long residence in Flushing, Mr. Henderson was identified with all public and philanthropic work. The Flushing Hospital, close to his nursery, is a monument to his benevolence, he having largely endowed it, and given the land on which it stands. He was president of the electric railway and vice-president of the Flushing Savings Bank.

Mr. Henderson was an accomplished linguist, speaking four modern languages with fluency, apart from his acquaintance with the classics. He made frequent trips abroad, both to the Continent and to his home country, for which he always felt a warm regard.

Mr. Henderson was naturally a prominent figure at all horticultural gatherings in and around New York. His slight figure and calm, benevolent face, framed in silvery hair, was always greeted with affectionate good will, and his suave dignity of manner and unvarying courtesy gained him the respect and regard of all who met him. He was a perfect gentleman of the old school, genial, upright and brave, with the courage of his convictions. He leaves a widow and two daughters.—*New York Times*.

JOHN HENDERSON

Came to Jersey City and begin business in a small way in forcing the finer kinds of vegetables for the New York market, a business of which he knew nothing, but his energy and strong common sense soon enabled him to equal and surpass most of his contemporaries. He gradually drifted from this business to that of florist, where he was more at home, for his early training in his father's firm of E. G. Henderson & Sons, Wellington Road, London, had made him an adept in all florist operations, so that by the time he had been in business five years he became noted as growing the best plants and flowers sent into the city of New York. Probably no man ever lived who saw quicker the way to develop the best qualities of plants than our old friend. He not only originated many varieties and developed the merits of others, but many valuable methods of culture were evolved

from his close observation and fertile brain, from which hundreds of your readers are now reaping the benefit without knowing to whom they were first indebted for such knowledge.

Although like most business men he had reverses, yet he successfully weathered them all, and two years ago, having amassed a fortune, he sold out his immense rose growing establishment in Flushing, N. Y., to a stock company.—*P. H., in American Florist.*

Tribute to the memory of John Henderson, prepared by C. L. Allen, and adopted by the New York Florists' Club.

Another good man has gone. Another page in history has been filled with the record of a noble life, closing with the tribute we now place upon his tomb. John Henderson's name is imperishably written in the history of American floriculture, and as indelibly engraved on the hearts of all who truly knew him. Cradled in the lap of wealth, endowed by nature with a love for the beautiful and good, educated at the fountain of English learning, visited in manhood's brightest years by the vicissitudes of fortune, he came among us poor but respected, and has departed from us rich and respected, bequeathing to his many friends gifts by example of honor, integrity, manly pride and virtue. His peculiarly fine moral qualities, his single-minded, straightforward manner, and his genial kindness, together with his confidence in his fellow men, were adorned by rare intelligence and high moral culture.

In his intercourse with his fellow men he was never affectionate, rarely confiding, but always superior. He could not freely mingle with the masses, because he scorned petty ways and many of the social customs that strongly tend to destroy individual worth and to undermine character. He loved quietness, pure thought, pleasant associations, the endearments of home, and abhorred every manner of vice and hypocrisy. When he professed friendship, he meant pure friendship, free from dross and unalloyed with selfishness.

While his ambition in his business relations was only limited by his strength, he was most temperate in his desires, his strongest being duty to his family, simplicity of life, unostentation, and to be associated in every good work with severely candid, unselfish, honest men.

Modesty was one of the virtues that adorned his character. While his mind was richly stored with that which was beautiful, true and good, with practical knowledge, it could not reveal itself except to his small circle of choice friends. With strangers he had no communion. To the general public, or to a large assemblage, he could not convey his thoughts.

HENRY SHAW.

Henry Shaw, the greatest philanthropist who has devoted his talents and wealth to the promotion of botany and horticulture in the New World, died at his home, St. Louis, in August. His greatest monument is the Missouri Botanic Garden, which is mentioned elsewhere in this volume. To the maintenance and extension of these gardens he left a magni-

ficent fortune. The following tribute to his memory is given by the Board of Commissioners of Tower Grove Park :

“Henry Shaw, born in Sheffield, England, July 24th, 1800, died at his residence, Tower Grove, August 25th, 1889. He came to St. Louis in 1819, engaged actively in business for more than twenty years, amassed a large fortune during an active and honorable career, and retiring about the year 1840, devoted his time to travel, study and other preparations for the scientific pursuits and public work which he subsequently undertook. Returning to St. Louis in the year 1848, he commenced the execution of his matured purpose—the establishment of a Botanic Garden for the adornment of the city of his home, the enjoyment of its citizens, the cultivation of taste and the advancement of science. He erected his country residence within the Garden grounds, and personally attended to all steps necessary in the development of his noble design. In a few years the Garden grew into order and beauty, and finally matured into one of the most complete institutions of the kind in the New or Old World. He found his pleasure in this pure and elevating task, but the ulterior design, steadily adhered to, was the benefit of all classes of society, and the creation for the use of the present and future generations of an institution directly ministering to the growth of the city, and in aid of higher tastes and manners and the spiritual elevation of society.

“In the year 1868 he deeded, as a gift to the city, the land embraced in Tower Grove Park, the only conditions being that the city should provide means for the work of improvement, for the annual maintenance of the same, and that a strip surrounding the Park should be leased for villa residences, the revenues from which should go towards the support of the Botanic Gardens. The actual land so dedicated to public purposes was 276 acres, and he designed the plan of the Park, the work of improvement being carried out under his personal supervision—all these difficult and valuable services being rendered gratuitously to the public. He lived to see the Park practically completed, and he also donated for its ornamentation the beautiful statues of Humboldt, Shakespeare and Columbus, and the six busts on the lawns surrounding the Music Pavilion. His chief enjoyment was the Park and Garden, and the spectacle of the people of the city visiting the lovely scenes he had created was to him a bright and unending pleasure.

“In addition to these remarkable acts of philanthropy and public spirit, he was the benefactor of various institutions of charity and learning, and an active patron of botanical science. Among his recent acts was the creation and endowment of a Chair of Botany in connection with Washington University and the publication of the Botanical Papers of Dr. George Engelmann, edited by Professor Asa Gray, of Harvard, assisted by Professor William Trelease, of Washington University, and distributed to scientific bodies throughout the world by the Smithsonian Institution.

“By his last will and testament the Missouri Botanic Gardens are placed upon a substantial and immutable basis. His whole estate, less only individual bequests, is created an endowment fund for their perpetual maintenance, under the management of a Board of Trustees.

“The fortune which Henry Shaw acquired in St. Louis he has thus given back to public uses in the direction of the furtherance of science, the eleva-

tion of taste and the enjoyment of the public. This is a life worthy of the respect and affection of all classes of society, and entitled to everlasting honor and remembrance from the community he strove so untiringly to benefit."

Mr. Shaw is remembered in botanical science by *Agave Shawii*, which the late Dr. Engelmann named in his honor.



FIG. 51. JAMES CASSIDY.

JAMES CASSIDY.

James Cassidy, professor of botany and horticulture in the Agriculture College of Colorado, died at his home at Fort Collins, Colorado, November 21st. The following account of his life and work is adapted from a tribute prepared by Frank J. Annis, secretary of the Colorado Agricultural College:

James Cassidy was born near London, England, August 5th, 1847. At

the age of twelve he was left an orphan, and while it is apparent that he had the advantages of a fine preparatory school while a lad, there is no evidence that he secured any of the benefits of an academic or collegiate training. It is well established that the orphan school of London furnished about all the instruction which he received, with the possible exception of special work which he may have done in the night schools of Manchester, while employed at his trade. It is certain that at a very early age he was placed where he acquired a thorough knowledge of floriculture and landscape gardening, as he is found at the age of eighteen in the employ of Rollison & Sons, leading nurserymen near London, and afterwards in the Royal Botanical Gardens at the same place.

Upon coming to America, he secured employment as a florist and gardener for General Howland, near New York. He remained in New York until about 1870, when he returned to England, and spent a year in practical work and study. When he returned to America, he placed himself under the employment of Peter Henderson, where he remained until March, 1874, when he was sent to the Michigan State Agricultural College, upon the recommendation of Mr. Henderson, to take the position of florist and gardener in that institution. Here he remained for nine years, gaining the esteem of the officers and students.

In January, 1883, he was called to the State Agricultural college of Colorado, as professor of botany and horticulture, and in a short time placed himself in the front ranks of those engaged in industrial training in this state. Horticulture by irrigation was a new field to him, but with industry and perseverance he entered upon the discharge of his duties, and soon made himself practically master of the problem. He identified himself with the leading horticultural societies of the state, at one time serving as secretary of the Northern Colorado Horticultural Association. He contributed many valuable papers to the proceedings of these associations, and they were always commended for their scientific and practical character.

During the years 1885 and 1886 he conducted experiments with potatoes and the growing of some of the finer varieties of tobacco. The results of these investigations appeared in a finely prepared report submitted to the State Board of Agriculture in December, 1886, and published in the report of the secretary for that year. Prior to that time he had done considerable general work in the study of native grasses of the state, as well as the general flora and noxious weeds.

In February, 1888, upon the organization of the agricultural experiment station, he was elected horticulturist and botanist of the station, and then it was that his line of original investigations began to take definite form and scope. In the early history of his department there had been no distinct line of work provided by the Board, and the subjects were largely of his own choice. His first contribution to the station work was in the form of Bulletin No. 4, on "Potatoes and Tobacco," published in February, 1888. The matter in this bulletin covered experiments extending over three or four years and enabled him to draw some satisfactory conclusions. Bulletins 6 and 7 were from his pen, the former upon "Insects and Insecticides," the latter upon "Potatoes and Sugar Beets."

During the last four or five years he had been making a special study of the native grasses and forage plants of this state. Last summer he spent about forty days on a trip to North, Middle and Egeria parks, making

large collections of native grasses and forage plants. He had about completed the manuscript for the bulletin on the native grasses at the time of his death. He had in preparation a work on the flora of Colorado; also on the noxious weeds which give so much trouble on the farm and garden. His collection and studies of the insect fauna of the state were considerable.

In 1888 Mr. Cassidy received a gratuitous degree of Bachelor of Science from the Michigan Agricultural College, and a year later he received the degree of Master of Science from his own institution.

He was an unobtrusive, modest but capable man.

WILLIAM CHORLTON.

William Chorlton, author of "The Grape Grower's Guide," died at his home on Staten Island, August, 1889. He was born in Manchester, England, in 1812. He was apprenticed to Mr. Fraser, a Scotch gardener at Manchester, and later he was gardener to P. M. James, a banker of his native city. Mr. Chorlton came to America in 1848, working the first year with Isaac Buchanan, a florist in New York and Astoria. In 1849 he became head gardener for the late John C. Green, New Brighton, Staten Island. Here he remained 18 years. In 1854 he wrote the work on grapes.

Mr. Chorlton went into business for himself in 1867, at West Brighton, as a general florist. Two years later he retired, turning his business over to his son-in-law. Samuel Henshaw became his successor at Mr. Green's.

He had varied talents, which he cultivated for personal gratification. He was somewhat of a poet, and he painted in water colors. He was an occasional contributor to the local press and the horticultural journals. His book was successful, for the time in which it appeared, and it is still in demand by those who grow grapes under glass.

AUSTIN M. HALE.

Adapted from a sketch by L. B. Pierce, before the American Association of Nurserymen.

Austin M. Hale, the introducer of the Hale's Early peach, died at his home in Magadore, Ohio, in February, 1889. He was born in Suffield, Portage Co., Ohio, in 1814. His father and mother came from New England in 1806 and settled on a large tract of land in Suffield.

Through this tract runs one of the principal tributaries of the Cuyahoga river, which received the name of Hale's brook, and on an elevated situa-

tion overlooking this creek four miles below in the adjoining county of Summit, Austin M. Hale, at the age of 17, purchased a piece of land and started in a small way the growing of budded and grafted fruit trees. His father had for many years made it a pastime and recreation to bud and graft and collect varieties, so Austin was not only familiar with methods of propagation, but had a fine specimen orchard at hand from which to procure scions.

In 1853 Mr. Hale took into partnership Dr. Mendall Jewett, who remained with him until 1860, when he removed to Middlebury, six miles west of Magadore, where he went into the nursery business with Dennis Hine, establishing a nursery that was finally crowded out by the growth of the city of Akron. After the dissolution of the partnership between Hale and Jewett, Mr. Hale took into partnership his two sons, then just attaining their majority, and the business was pushed with vigor, the annual sales of trees grown on the place reaching \$4,000 and upwards. 200 acres of excellent land were added to the estate and the boys turned farmers, while Mr. Hale continued the business alone until his death, having lived nearly 58 years in his home overlooking the little village of Magadore.

Mr. Hale built himself a monument more enduring than marble in the introduction of Hale's Early peach. He learned in the autumn of 1852 of an extremely early peach in Randolph, some eight miles east of his nursery. He made some investigation, and on July 7, 1853, he drove over to see this new peach, but was extremely disappointed to find that it had ripened and gone. Just why it ripened so much earlier than it afterward did, which is about the 20th of July in average seasons at Magadore, does not appear, but there is no doubt about the fact that it ripened that year about the 4th of July. The original tree was owned by a German named Moore, who said he raised it from a pit brought from Germany by himself six years before. Soon after, Mr. Hale took buds and set them in his nursery and the following winter (a cold one) killed the original tree, and thus it happened that Mr. Hale's enterprise alone saved to the world this peach, which was an advance of nearly three weeks in earliness over Early Tillotson, at that time the earliest known peach. The following year, Dr. Jewett, Mr. Hale's partner, whose instincts were those of a physician and amateur horticulturist more than a nurseryman, gave away buds to several parties, and thus it went out of Mr. Hale's control and soon after fruited in several places. It at once sprang into popular favor, and M. B. Bateham named it Hale's Early, although it was staked in the Hale & Jewett's nursery as Early German.

Mr. Hale collected nearly 100 varieties of peaches upon his place and about the some of apples. Among the rarer apples always kept in stock by Mr. Hale and now to be found in many orchards in Summit and Portage counties, were Western Beauty (also called Merton and Summer Rambo), Star, White Baldwin, Upson's Huron, Weaver Sweet and Bronson Sweet.

Mr. Hale was a genial, intelligent conversationalist, but a man of very decided views. He was a strong abolitionist and kept a prominent station on the underground railroad, giving shelter and aid to fleeing slaves when it was a criminal offense to do so. Stephen Foster and wife, Abby Kelly, Parker Pillsbury, Henry C. Wright, Maurice Robinson, and other prominent abolitionists, were personal friends and sometimes visitors at his home. Later in life Mr. Hale was an ardent prohibitionist.



FIG. 52.

HEINRICH GUSTAV REICHENBACH.

(Cut from Gardeners' Chronicle.)

Professor Reichenbach, the recognized leader in orchidology, died May 6th. He was born in Leipsig, Jan. 3, 1823. His graduation essay was on the origin and structure of orchid pollen. This was published in 1852, from which time his talents were devoted to orchid study. From 1863 to the time of his death he held the professorship of botany and the directorship of the botanic gardens at Hamburgh.

“Since the death of Dr. Lindley, in November, 1865, Professor Reichenbach had been universally recognized as the orchid king. He had studied orchids since 1841, and was a most devoted and painstaking historian of the order, whose descriptions of new species and varieties were always eagerly anticipated, whose identification of plants sent to him for that purpose was always accepted without question. For many years past he took a leading part at most of the great horticultural and botanical congresses held in Europe, and was one of the vice-presidents of the congress held in London in connection with the memorable International Horticultural Exhibition held in 1866. But for indisposition he would have been present also at the Orchid Conference held at South Kensington in 1885; but the great and valuable services he had rendered to orchid growers were not forgotten in his absence, and he was awarded one of the Veitch Memorial Medals, placed at the disposal of the Conference Committee by the trustees.

Though orchids were the special object of his affections—and he had amassed an extensive collection of typical specimens in his herbarium, which we hope will be secured for Kew—the professor contributed largely to our knowledge of the plants of Central Europe. In his own special line he was a veritable Triton among minnows, and his loss will be severely felt for some time to come.”—*The Gardening World*.

“It must not, however, be supposed from our remarks that Professor Reichenbach was exclusively an orchidographer. He is best known to horticulturists in this field, but botanists have to thank him for the zealous collaboration he gave to his father’s grand undertaking, the *Icones Floræ Germanicæ et Helveticæ*—a work devoted to the description and illustration of the plants of Central Europe, and of which Heinrich Gustav Reichenbach, the younger, edited the later volumes, and illustrated them with his own hand, contributing no fewer than 1,500 drawings. The first volume of this extensive and valuable publication which Professor Reichenbach edited, was, naturally enough, that devoted to the Orchids of Europe. It bears the title *Tentamen Orchidographiæ Europææ*, and is dated 1851. ‘For ten years,’ says the Professor in the preface of the volume, ‘I had devoted myself to the study of orchids.’ Since 1841, then, our Professor had most diligently studied orchids, often in association with Lindley, who repeatedly acknowledged his obligations to the subject of this notice.

“In consequence, it is scarcely possible to take up a set of volumes of periodical botanical literature, German, French, or English, or any work devoted to the enumeration of the floras of distant lands, without meeting traces of the Professor’s industry and research. Our own columns in particular have been enriched with very numerous descriptions of the orchids that have been from time to time introduced into cultivation. Of separate publications we may mention the well known *Xenia Orchidacea*, which has appeared in occasional fascicles from 1851, with about 900 drawings from the Professor’s pencil, and the *Observations on the Orchids of Central America*. Professor Reichenbach is also the author of the synopsis of orchid lore contained in the sixth volume of Walper’s *Annals*.

“Professor Reichenbach always took a lively interest in horticultural exhibitions, both on the Continent and in this country, and was frequently called on to act in the capacity of judge, especially where orchids or new plants were concerned. At the several Horticultural and Botanical Congresses Professor Reichenbach generally took a prominent part.’ —*The Gardeners’ Chronicle*.

Professor Reichenbach’s collection of specimens and drawings is now the property of the Imperial Hof Museum, in Vienna, that institution having accepted the peculiar terms of the will. The will provides that the specimens are to be sealed up for a quarter of a century, a provision which has called forth regret and disappointment from the scientific world. This provision of the will reads as follows :

“My herbarium and my botanical library, my instruments, collection of seeds, etc. accrue to the Imperial Hof Museum in Vienna, under the condition that the preserved orchids and drawings of orchids shall not be exhibited before twenty-five years from the date of my death have elapsed.

Until this time my collection shall be preserved in sealed cases. In the event of the Vienna Institution declining to observe these conditions, the collection falls under the same conditions to the Botanical Garden at Upsala. Should the last-mentioned institution decline the legacy, then to the Grayean Herbarium in Harvard University, Cambridge, Mass. If declined by that institution, then to the Jardin des Plantes, at Paris, but always under the same conditions, viz., of being sealed up for twenty-five years, in order that the inevitable destruction of the costly collection, resulting from the present craze for orchids, may be avoided."

* *
*

CAPT. J. H. DRUMMOND, of Glen Ellen, California, died December 20th. He was a well known viticulturist, and for many years he labored to advance the wine interests of California.

* *
*

GABRIEL MARC, a prominent local horticulturist, of Woodside, N. Y., died early in the year.

* *
*

The committee on obituaries of the Society of American Florists reports the following deaths since the fourth meeting (August, 1888), not all of which occurred in the present year: Harry S. Garrow, Pittsburgh, Penn.; H. B. Morse, Natick Mass.; H. J. McGall, Orange, N. J.; D. Wilmot Scott, Galena, Ill.; John Craig, London, Ontario.

* *
*

ROBERT MARNOCK.—The English journals announce the death, in his ninetieth year, of Robert Marnock, the foremost landscape-gardener who has appeared in England during the second half of this century, and one of the best exponents of the natural style. He served his apprenticeship as a gardener and found his first public employment in designing the Sheffield Botanic Garden, of which he became the first curator—not a bad training for a landscape-gardener, and one which led to his selection, in 1839, to lay out the garden of the Royal Botanic Society in Regent's Park in London. This established his reputation, and he has since been kept busy in the practice of his profession until his retirement a very few years ago. Marnock was strong in artistic feeling and in his practical knowledge of plants; and here was the secret of his success. The artist and the gardener worked together, and his creations

were gardens gracefully and tastefully arranged, but gardens in which plants were always the principal and controlling feature. It never fell to his lot to make any great urban pleasure ground, or to design one of those broad landscapes which tax the highest creative skill of the artist, but in his particular field Robert Marnock was, in his day, without a rival. As a man he was singularly modest and attractive.—*Garden & Forest*, Dec. 11.

* *
*

DR. WARD died Dec. 18th, at Southampton, England. He was a well known grower of orchids, and he will be remembered in connection with the beautiful *Dendrobium Wardianum*.

* *
*

MILES JOSEPH BERKELEY, the eminent cryptogamic botanist, died at Sibbertoft, near Market Harborough, England, on July 30th, at the age of 86. His services in the knowledge of plant diseases are inestimable.

* *
*

J. A. MCKENZIE, the well known landscape gardener and surveyor of Epping Forest, England, died during the year.

* *
*

M. SAGOT. A botanist who was well known in France for researches in the flora of French Guiana, and his numerous essays on the cultivation and acclimation of tropical plants.

* *
*

DON SEBASTIAN VIDAL, died July 28. Señor Vidal was the Director of the Botanic Garden at Manilla, and inspector of the Forest Department of the Philippine Islands.

* *
*

PIERRE BERNEDE, a well known rose grower of Bordeaux. Among the roses which he has sent out are the following: Teas; *Comtesse de Labarthe*, *Madame de Tartas*, *Rosomane Hubert*. Hybrid Remontants; *Mademoiselle Juliette Doucet*, *Mademoiselle Louise Boyer*, *J. A. Escarpit*, *Madame Daurel*, *Madame de Selve*, *Mademoiselle Jeanne Bonnet*.

* *
*

FELIX BONCENNE, died February 13 at Fontenay-le-Comte, Vendée, France, in his 83rd year. A well known writer,

author of *Traite d' horticulture*, used in the public schools of France, President of the horticultural society of Fontenay-le-Comte, and long a contributor to *Revue Horticole*.

* *
*

PIERRE MOREL died early in the year. He was for more than thirty years director of the horticultural establishment at Lyons.

* *
*

C. F. MARTINS, director of the Botanic Gardens, Montpellier, since 1851, one of the oldest botanists in France, and the author of numerous scientific papers and works. He was 83 years of age.

* *
*

J. E. MICHAUD, for many years connected with the distinguished firm of Vilmorin, Andrieux et Cie., Paris, giving particular attention to the department of grains and seeds. He died in his 63rd year.

* *
*

M. QUIHOU, formerly the chief of the famous Jardin d' Acclimatation of the Bois de Boulogne, Paris, a life-long horticulturist, died January 29th, in his 68th year.

* *
*

M. GAULIN, head of the greenhouses of the Park Tete-d' Or, of Lyons, and well known through his culture and hybridization of agaves and other plants.

* *
*

HENRY VICTOR CONTURIER, a well known nurseryman of Saint-Michel-Bougival, Seine-et-Oise, France, died June 15th in his 70th year.

* *
*

LOUIS DELRUE-SCHREVENS.—President of the Royal Society of Horticulture of Tournay, Belgium, died during the year.

CHAPTER XII.

HORTICULTURE IN OTHER LANDS.

1 Horticulture in Paraguay.

BY DR. THOMAS MORONG.

Scientific horticulture in Paraguay does not exist. In fact, nearly all the cultivation of the soil to be seen here, whether in the field or the garden, is on a limited scale, and accomplished by the rudest instrumentalities. Not that the land is infertile, that it lacks any element of soil or atmosphere necessary to produce various and abundant crops, but its people are little acquainted with the arts of agriculture or the improved methods and implements employed in Europe and North America. Besides this, the population is sparse and scattered. Probably the inhabitants do not number to-day over 200,000, and at least nine-tenths of the country is a wilderness.

The best cultivated farms and gardens are to be found in or near the cities and towns, the principal of which are about fifteen in number, Asuncion, the capital, being the largest, and estimated to contain 20,000 or 25,000 inhabitants. We must look to the emigrant colonies, now three in number, and the estancias of foreign residents to be seen here and there in the country districts, for most of the improvements which have been made in agriculture and horticulture of late years. The native Paraguayans, who live for the most part in mud cabins and unenclosed yards, depend merely upon indigenous growths and the old Indian style of cultivation.

The common fruits, which thrive with very little culture, are numerous and excellent. The first and most important of these

is the orange, of which there are many varieties, both sweet and sour. One of these, I am told, is called the "Mandarin," probably a misnomer for "Tangierine," a well-known variety with a loose, flaccid rind and insipid juice. There are two kinds of this, one very large and one quite small, both of them esteemed in Paraguay as remedies for the "chucho," a form of fever and ague common in the country. Still another variety, with rather small fruit and insipid taste, is regarded by some persons as indigenous, but that remains to be proved. The sweet orange (*Citrus Aurantium*) it is supposed was introduced into the country some three hundred years since by the Jesuits. The fruit is large, very sweet, juicy and luscious, and the tree may be raised from the seed or cuttings without need of grafting. After it is once planted it grows without the least care, and is productive for thirty years or more. The orange tree in Paraguay often attains a height of sixty feet or more, and when well developed and covered with its white, fragrant blossoms and fruit in all stages, and its deep green, glossy leaves, it is one of the most beautiful objects in nature.

Allied to the orange is the lime (*Citrus Limetta*), which bears a sweetish fruit nearly as large as the orange, and the lemon (*C. Limonium*), of which, likewise, there are several varieties, the best of which has a small, ovate, smooth, thin-skinned, fragrant, juicy fruit, containing only two or three, and sometime no seeds. The large, thick and rough-skinned lemon of the Mediterranean region does not seem to occur in this country. The citron (*Citrus medica*) is also common in the gardens, yielding a fruit of fine quality. I have seen specimens for sale in the market which measured six inches or more in diameter. The orange is used principally for the table, but its juice is sometimes expressed as a flavor for drinks and ice-creams. So far as I know, no use is made of it for cooked dishes. Of the citron, sweetmeats and jellies are sometimes made, but it is little valued in Paraguay.

Second in rank to the orange is the banana, which grows luxuriantly, and with but very little cultivation, all over the country. There are numerous varieties, the most palatable of which that has come under my observation being a small fruit not over three inches in length, with a smooth, green rind and nearly seedless.

The pineapple (*Ananassa sativa*) is equally common, and

when fully ripened is of first-rate quality. The leafy tops of the apples are set out in rows, and soon take root and develop into stems one to three feet in height and producing a fresh fruit at the summit.

The guava (*Psidium pomiferum*) is very common in the wild state, and often planted in gardens. It yields a fruit about the size of an apple, with a sweet, reddish pulp and numerous seeds, and is frequently put up in cans as a preserve or jelly. Birds and animals are very fond of it.

The *Carica Papaya*, or *mamona*, as it is commonly called in Paraguay, or, occasionally, *papaw*, is another garden fruit which is very common throughout the country. This is a small tree, twenty or twenty-five feet high, that bears clusters of fruit in the axils of the lower leaves. The fruit is as large as an orange when ripe, but quite insipid in taste. It is rarely served upon the table and never employed in cookery, so far as I can learn.

The peach is frequently cultivated, but unless in exceptional situations and given especial care, its fruit is small, hard and nearly worthless. The same may be said of the grape, so far as my own observation goes. I have often bought the grapes which are offered for sale in the Asuncion market and in the towns along the line of the railway, but have never yet seen any that I regard as worth the eating. Still, it must be said that the grape has hardly been given a fair trial in Paraguay, and conflicting accounts are given in regard to the success which attends its culture. Some estancieros tell me that they have succeeded in getting good grapes, while others have entirely failed. "The Emigrant's Guide Book," an official publication of the Paraguayan government, states that the vine flourishes here, that "*magnificent* raisins" have been made of the grapes, and that experiments show that good wine might be made from them, all of which statements are rather *coulcur de rose* than true in fact. The grape is not a native of the country, and the probable truth about it is that the soil is too dry and sandy and the climate too hot for the grape ever to do well here, except on a limited scale. As to getting *magnificent raisins*, or any raisins at all, I am exceedingly skeptical.

What is true of the grape is equally true of the pear, the apple, the quince, the apricot, the plum and the almond.

Many attempts have been made by foreign residents to raise these fruits in Paraguay, but with indifferent success.

The fig, on the contrary, is one of the fruits which takes kindly to the soil of this country and thrives finely. I see it occasionally in the gardens, but although it grows into a large shrub and bears abundant and excellent fruit, no attempts are made to cultivate it upon any extended scale or to produce dried figs. In time the culture of the fig may become profitable, as the long summers, hot sun and moist atmosphere of Paraguay seem peculiarly adapted for fig drying.

Of the smaller fruits, such as gooseberries, raspberries, blackberries, currants, blueberries and cranberries, rather abortive efforts have been made to raise the first three only, the others never. I am told that strawberries have been raised in some localities of fair quality, but I have seen none and do not believe that either soil or climate is suitable for strawberry culture.

I find growing wild two edible-fruited eugenias and one styrax. The fruits are about as large as plums and are sold in the markets. *Eugenia cauliflora*, a purple fruit, and *Styrax reticulata*, a yellow fruit, are both shrubs and are worth a trial in the United States. The other eugenia, with a yellow fruit, is a very large tree and hardly worth an experiment. The purple one is known as *Iba-viyu*, and is called *Myrtus guaviyu* by Parodi, in his catalogue of Paraguayan plants.

Much might be said of tobacco, cotton, sugar cane, rice and coffee, all of which do so admirably in Paraguay, but these belong to the field rather than the garden.

Of vegetables, the most commonly cultivated and valuable plant for table supply is the *mandioca* or *manioc*, or *cassava*, as it is called in some books. This is a soft-stemmed shrub some five or six feet in height, consisting of two species very similar in general appearance, the one with poisonous juice and known as "*mandioca brava*" (*Manihot utilissima* of botanists), and the other with innocuous juice, popularly called "*mandioca dulce*" (*Manihot Aipe*). The root or esculent portion is from one to three feet in length and from one to three inches in thickness, covered with a brown epidermis, with a white, juicy, granulated interior. For sale in the market, the root is taken when about the size of a parsnip or carrot, or else broken into pieces about a foot long. Either species may be

used as an esculent, if care is taken to grate or grind the root finely, to express the juice thoroughly and to dry the meal in the sun or a kiln, a process which entirely removes all the deleterious principles from the poisonous species. Both of them are used to manufacture starch and flour, and the *mandioca dulce* is universally used as a table vegetable, being boiled like the parsnip, which it somewhat resembles in taste. The boiled root is often put in soups, or sliced in chips and fried like the "Saratoga chips" of the potato in our country, and forms a very palatable article of food. In the form of flour, it is finely pulverized and made into bread, called "*chipa*," or else dried in lumps, when it becomes the tapioca of commerce. In preparing the chipa bread, the mandioca flour is mixed with a little ground rice, cheese and coriander seed, made up into rolls or rings and baked in an oven. It is the common bread of the country, and when fresh not at all inferior to the bread made of wheat flour. In fact, it subserves all the purposes for which wheat flour is used. I have eaten delicious sponge cake made of it, and it answers equally well for all kinds of pastry.

Next to mandioca as an article of food is corn, or "*maiz*," as it is commonly called here, which is largely cultivated in gardens over the country. This, however, is not the glossy-grained maize or Indian corn of New England, but more like the white corn of our southern states. Apparently it has become mixed with a yellow variety, as in color the ears are spotted or blotched with yellow, and they are considerably smaller than those of the southern corn. When eaten, the ears are either roasted before the fire or the kernels are ground into meal or broken up in a mortar and made into bread, much in the same manner as the chipa. Chipa and maiz bread are the staple food of the native Paraguayans. Sweet corn, such as we have in the United States, I have never seen here, although there is no reason why it might not grow.

Potatoes of all kinds are easily produced in the market gardens. The Irish potato is everywhere cultivated, but whether owing to the character of the soil or the lack of attention (probably the latter), it is much inferior in size and quality to the potato of our country. Small potatoes, not much larger than a marble, and somewhat watery, are frequently exposed in the markets for sale and put upon the restaurant tables. Sweet potatoes and yams do much better. The finest sorts

may be raised here, but such poor culture is given them that they are generally of an inferior character. In cultivation the people throw the joints of the vines into plowed furrows or dibbled beds, and then leave them to come up and live as they can. In table use they are either roasted in hot ashes or stewed or fried in slices.

Pea-nuts (*Arachis hypogæa*) are another garden product very common in Paraguay. The soil and climate are well calculated to produce first-rate qualities, but like everything else here, they suffer for want of generous treatment. The farmers of North Carolina would hardly be willing to father such starving pea-nuts as are found in the markets of Asuncion. Strangely enough, too, nobody in Paraguay seems to have caught the idea of roasting the nuts, and they are eaten by the people in the raw state. Occasionally I meet a family from the United States who have taught their servants how to roast the pea-nut, but they cannot induce the natives to eat it. Evidently the Paraguayan gustatory organs need to be educated!

Melons thrive well here, although little attention is paid to them. The water-melon might be raised in quantities, and of the finest quality, but those actually raised by the people are small and somewhat musty in flavor. One of the chief faults in gardening among Paraguayans is that they will pluck their produce long before it is ripe. They do this even in the case of the orange, and were it not that the orange tree yields such an abundance of fruit and for many months in succession, we should never be able to obtain it well ripened. The water-melon, of course, stands no chance under such a practice. I have occasionally, in the way of experiment, bought samples in the market, and though the melons were pronounced by the vendors "*linda, linda*" (beautiful, beautiful), I have always been obliged, after tasting, to toss them into the street. The muskmelon receives a better treatment, and one may obtain in its season fine examples of this fruit, as good as any grown in the United States. The little green cantaloupe so common in Maryland has, apparently, not found its way to Paraguay. The watermelons, muskmelons, pumpkins and squashes are all, evidently, the European and North American forms. The cucumber is the same, but it is not common. There are some gourds, out of which the people make *mate* and drinking vessels.

"Green garden sauce," as they call it in New England, of

various kinds, is the principal product of the market gardens in the vicinity of the towns. Nearly all kinds grow continuously the year round. Peas and beans are largely cultivated. The peas are usually quite small, resembling the variety which we call bush or early peas. Both the field bush bean and the large climbing bean are raised, and are used both as string and as shelled beans. Tomatoes, turnips, onions, egg-plants, beets, pumpkins, squashes, carrots, cabbages, cauliflowers and turnip-radishes abound, but, as a rule, of small and inferior kinds. The people seem to have no idea of the numerous and improved varieties of these vegetables which are known to the gardeners of our country.

As salads, I find in use lettuce, endive, parsley, chickory and a water-cress known popularly as "*berro*." By far the best of these is the lettuce, of which two forms, the curled and the smooth-leaved, occur. The cabbages would hardly draw a prize at our agricultural shows, as they rarely develop into heads, or, at least, into heads bigger than a base ball. The leaves are sometimes prepared in the form of what we call a "boiled dinner," but for the greater part they are chopped up and used in soups under the name of "*verdura*," or "green stuff."

Asparagus is also raised to a limited extent, and cooked and eaten as in our country. I hear also that foreign residents have endeavored to raise celery, but invariably without success.

As to ornamental gardening in Paraguay, not much can be said. The country has hardly progressed far enough for that. Such a thing as a public square or garden, decorated with ornamental shrubbery and flowering plants, is probably not to be found in any of the cities or towns. In Buenos Aires there are some very handsome, well-laid out public gardens, which are a mass of rich bloom throughout the warm weather, but nothing of the sort in Asuncion. The nearest approach to it that I have seen is the plaza, or great market square in the heart of Asuncion. One half of this is an open sand bank, generally occupied by a miscellaneous collection of donkeys, with large panniers strapped across their backs, in which the market women have brought their fruits and vegetables to market, and strange looking ox-carts bearing charcoal, fuel, wood, bales of alfalfa, thatching-grass and other articles. The other half of the plaza is enclosed by an unsightly wire fence, along two sides of which

grow a few stunted orange trees, cocoa palms and Araucarian pines, the latter being one of the few exotic trees which have been introduced into the country. A solitary Mexican agave is all that adorns the other two sides. The interior of the enclosure is a mere waste of sand, partially covered with stunted grass. This caricature, which might have become a thing of beauty if ever finished, is, I am informed, one of the many essays of Lopez, who attempted, some 30 years ago, to erect public buildings and to form public gardens similar to those which he had seen in his European travels. The war between Paraguay and the allies interrupted his projects, and since his day no efforts have been made either to complete his designs or to beautify the city with other works of the kind.

The plazas of other Paraguayan towns and villages—and all of them are constructed with a central square, in which stands a church, surrounded at a considerable distance by the shops and dwelling-houses, a plan invariably adopted by the early Jesuit settlers of the country—are uneven squares of land, covered with poverty-stricken grasses, upon which horses, donkeys and cattle graze at will.

A few of the “quintas” or country residences of gentlemen, indicate some attempt at “grounds.” The most that is done in this line, however, is to set out rows of flowering shrubs in an irregular manner by the sides of the walks and fences. The shrubs seen in such gardens are, many of them, peculiarly beautiful, the flowers being of the most showy kinds, but no care is taken to arrange them artistically. The favorite sorts are exotic acacias, euphorbias, daturas, the *Meli Azedarach*, here called the “Tree of Paradise,” jessamines and oleanders. The native vines, shrubs and trees, of which there are numerous species, many of them possessing charming foliage and flowers, are seldom cultivated. Now and then there may be seen a transplanted vine belonging to the order *Asclepiadaceæ* or *Convolvulaceæ*, climbing over trellises in front of dwelling-houses, and occasionally a native shrub or tree by the garden fences. Of bedding flowers, little else is to be seen, except the petunia, zinnia, marigold, tuberose, coxcomb and the four-o’clock, but these will grow spontaneously after having been once planted, and they are usually left to straggle about at will.

I am bound to say, in passing, that there is a single instance of a more pretentious character in Asuncion. This is a small

front garden laid out in walks and triangular beds, in which are growing several European flowers, such as larkspur, catch-fly, gilliflower and the like, but I fear that this is the only instance of the kind in Paraguay.

I am told that the ants, whose name here is legion, devour the roots of herbaceous flowers, and that they are apt to die off in the sandy soil and under the summer heats, so that it is of little use to sow annual flower seeds, but I am inclined to think that, with a good protection of tree and shrubbery shade, these difficulties might be overcome. Certainly, lawns might easily be made, as there are several indigenous grasses well adapted for that purpose, and rain is common enough in the country to keep them green; but I do not remember to have seen one.

In rambling over the country, I come occasionally upon rough garden hedges made of cactus or agaves, or, most commonly, of a very thorny and bushy shrub which bears a large purple flower, resembling a camellia, here called *amapola*; but such regular, close-clipped hedges as those of the arbor-vitæ in the States are unknown. The arbor-vitæ would not probably live here, but the osage-orange, the buckthorn and other species employed for hedging at home might do so. Certainly, rose hedges might easily be grown, as the rose thrives admirably in Paraguay. The very choicest varieties for color, size and perfume that our conservatories and gardens exhibit will live out of doors all the year, growing into large shrubs, and what is more, this plant does not seem to be attacked here by the slug or any other insect. It is a great wonder to me that the queen of the garden seems to be so little prized in a land so admirably adapted to its culture.

The most hopeful experiment in the way of parks and ornamental gardening which has come under my notice is the estate of Herr Mangels, for many years German consul in Paraguay. This gentleman has purchased a large tract of land about a league from Asuncion, erected a handsome castle-like mansion upon it, and laid out several hundred acres in a park and gardens. He is experimenting with good success in the culture of various native and foreign fruits, plants and flowers, and although his grounds are still in a rough state and not laid out with much artistic taste, yet they serve to show the possibilities of floriculture and arboriculture in this country when skillfully treated. I saw in his garden fine large trees of the

India-rubber tree of India (*Ficus elastica*), the Araucarian pine, the date palm of Africa, and quite a number of the beautiful epiphytes of Paraguay clinging to trees upon the grounds, or to the sides of the buildings. There, too, he has the sandalwood of India, the Yerba-maté (a native of Paraguay), the sterculia nut and many herbaceous plants of equal interest.

As emigration increases in this country and men of means and taste multiply, it may be hoped that such estates as this will become common, and that there will be more progress in horticulture, practical and ornamental. At present, as may be seen from this sketch, all these things are in their infancy. The cultivation of the soil, as a general thing, is crude and irregular. The methods are poor, the tools are poor, and no standards of taste and skill are set before the people. It looks now as though emigration and colonization from abroad were to be the main avenues through which the resources of the country are to be developed and the tastes of the native population stimulated and refined.

2. *Trees and Fruits on the "Palm Hills" of India.**

BY REV. S. B. FAIRBANK.

The Palani mountain tops share in the south-west monsoon, which lasts from June to October, and which is the means of watering the western part of India. But they are at the eastern part of the Animalai mountains (the mountains of Cochin and Travancore) and get more rain from the north-east monsoon, which lasts from October to December inclusive, and so this is called the rainy season. This year no rain fell here in January and February, but it began in March and has fallen plentifully in every month since. In some years not less than three inches of rain has fallen in every month of the year.

The soil is disintegrated gneiss and vegetable deposit. There is so much sand in it that it does not form mud, even when thoroughly saturated. But in most places, by digging a few feet, we find a yellow clayey soil which makes excellent mortar, and the houses are built of stone with this clay for mortar. There is no lime in the soil, and that, when required,

* The "Palm Hills," or Palani mountains, are located in the south-western part of India in the Madras Presidency. Mr. Fairbank, an American missionary, has lived for over forty years in the neighborhood of the Palanis, mostly at Ahmednagar, in the Deccan.—L. H. B.

is brought up from the plains on the heads of carriers or on pack-horses. As yet, there is no carriage road made up the hillside. The soil and climate are finely adapted for the growth of trees.

Most of the great plateau on the hill top, which is some 30 by 10 miles in extent at the higher elevation of 5,500 to 7,500 feet, is covered with grass. There are small groves of the primeval trees. These are called *Sholas* or *Kanals*. The *Kodai Kanal* (*i. e.* "umbrella grove") is a mile long by a quarter to a third of a mile wide. The *Peria* (great) *Shola*, four miles to the east of the *Kodai Kanal*, is two miles long by a mile wide. Then there is a lower plateau called the "Lower Palanis," which is some 15 by 20 miles in extent, and was covered with trees. Much of it has been cleared for the cultivation of coffee, tea, cardamons, bananas, etc. Some of the old trees have been left, and there are immense ones of cinnamon (*Cinnamomum iners*), nutmeg (*Myristica*), olive (*Eleocarpus oblongus*), jack-fruit (*Artocarpus*), jambul (*Eugenia*), two kinds of black-wood (*Dalbergia*), teak (*Tectona*), sal (*Shorea*), four kinds of tetranthera (belonging to the *Lauraceæ*), two monoceras (of the *Eleocarpaceæ*), sandal-wood (*Santalum album*), bamboos, palms (*Caryota*, *Borassus* and *Cocos*), chanepa (Magnolia tribe), etc. I have said that some of these are immense: they are the cinnamon, monocera, olive, jambul, etc. The people cut the teak, sal, black-wood, venga (*Pterocarpus*), and others that are more valuable for timber, before they become very large.

The trees in the groves on the upper plateau are good for fuel, but are little used for timber. Large groves are being formed of the Australian eucalypti and acacias. These grow with great rapidity, and seem to find the soil and climate more congenial than those of their native Australia. The blue-gum (*Eucalyptus globulus*) grows fastest and becomes the largest of these trees. One from a seed which I planted in the spring of 1887 is now 20 feet high and 22 inches in girth at the ground. It is now gaining more than a foot in height each month. One that was planted in 1853, a seedling of one year old, had become when I first saw it, in 1886, an immense tree, measuring 9 feet 4 inches in girth at a yard above the ground. There were two others planted at the same time in the same yard, each of which measured 9 feet in girth. They have been cut and the stumps dug out. But the largest one is still growing, and is

17½ feet in girth, a yard above the surface of the ground. When the stump of a cut blue-gum is left, it sends up sprouts, and one of these will form a tree of the size of the one cut in a year or two less than the original seedling required to reach that size.

I think that the wood of the blue-gum, especially of older trees, is good for the purposes to which white pine is applied. The trees grow straight, and are frequently without a limb, when 10 or 12 years old, to the height of 40, 50 and 60 feet. For timbers for the roof of a house, or where it is not exposed to dampness, it is unexceptionable.

The red-gum (*Eucalyptus obliqua*) forms a smaller tree, but the wood is preferred to that of the blue-gum for timber. Less of it is grown than of the blue-gum.

The wattle (*Acacia melanoxylon*) also grows rapidly, and to the height of 75 or 80 feet, and in some places to 100 feet, and to 4 feet girth, as straight as an arrow. The wood was expected to be good for making furniture; it was said to be used for that purpose in Australia, whence it came. But here it is used only for fuel and for posts, etc.

The "acacia" (*Acacia decurrens*) grows any way but straight. It is hard to find a stick that is straight for 15 feet in length. The wood is excellent—heavy, tough, durable, and does not split when seasoning.

These two acacias spread rapidly by shoots from the roots and by seeds. There were originally but three, so an old resident told me, in a grove of them that now covers more than 10 acres. The whole grove is the progeny of those three trees. The shoots from the roots of *Acacia decurrens* come up as thickly as those of hazel in a hazel patch in Illinois.

We need to grow the jarra or yarrah (*Eucalyptus rostrata*), and one man says that he has young plants of it growing. The Australians are said to value it the most highly of their woods, because when used for docks the teredo does not bore into it.

The fruit trees of the temperate zone usually do well on the Palanis. The apples and pears that have been introduced are in good bearing. I brought many kinds of American fruit trees here last year, and they are promising. There is a large hard pear called the cooking-pear, with a fruit that often weighs two pounds. It furnishes admirable stocks for other pears, grows rapidly from cuttings, and has become very

abundant on the hills. There is also a kind of small apple that has become fairly abundant. It throws up shoots from its roots, which are dug up and used as seedling apples are used in the United States. The cooking-pear furnished me with abundant juicy stocks, and I found it easy to propagate my American pears by budding on them. A little Bartlett pear furnished me in April with 32 buds. These were inserted in the shoots of the cooking-pear and all grew. They made shoots in two months from one foot to two and a-half feet long.

In August I used some buds from these shoots, and they are (October) growing, bearing two or three leaf buds to shoots three inches long. These are the grandchildren of that little Bartlett pear tree—two generations in five months. The temperature varies very little through the year here. The thermometer does not rise at Kodai Kanal above 75 degrees Fahr., and except in low places by the lake, I have never seen the thinnest ice formed. So, I think I could secure the fourth generation from that Bartlett pear in one year in my open nursery.

I had trouble in finding stocks of apple and peach in sufficient quantity for my purpose. The apple seeds I have tried have not germinated, and but few of the peach pits. I tried them cracked and uncracked; but one day a neighbor said that peach trees would grow here from cuttings. I hastened to put out a lot of peach cuttings and they are growing finely, and will be big enough to bud when I come here again next March. I put out apple and lemon cuttings at the same time, and they also are growing. This year has been an unusually rainy one, and so very favorable to the sticking and growing of cuttings. But I think that cuttings from all the hard-wood fruit trees of the temperate and torrid zones may develop into trees here; so that stocks will be provided for budding; or the branches of good fruit trees may be cut in pieces and grown into trees, just as we treat roses.

I have a hedge of our hedge-rose that will soon protect my garden. I selected the cuttings in March and April. The mass of shoots is now two feet wide and two feet high. I nip the tips to thicken the hedge, and after it gets larger, the lower branches will fade and then become black under the shade. But they will not rot. They will remain like barbed wire, and if the hedge is carefully trimmed from the first, fowl will not be able to get through it, nor any animal to get over it when it is two

years old. The plant is a cluster rose, with a dozen or twenty light rose-colored flowers in a cluster, and is in blossom all the year round. Our raspberries, too, especially *Rubus Molluccanus*, which has large undivided leaves and is covered with hooked thorns, make good hedges.

Then we have *Pithecolobium dulce*, a leguminous tree, with two thorns to the axil of each leaf that are sharp as needles and that remain permanently. This put out with the plants four or five inches apart makes an impervious hedge. If uncut, the butts of the trees will come together, for a full grown tree becomes a foot in diameter. This makes the strongest of hedges; one which cannot be passed without cutting away some of the trees with an ax.

We have three kinds of wild raspberries. One is probably *Rubus racemosus*, or a variety of *R. lasiocarpus*, and another is *R. Molluccanus*. The latter bears a black and sour berry that is good for cooking, but is unfit to eat raw unless it is very ripe. One has a yellow fruit with a vinous flavor, and the whole plant is covered with a pruinose bloom. Another resembles your wild black-cap, but it spreads by suckers and never by rooting tips. It gives promise, for it has as good flavor as any raspberry I ever tasted.



INDEX

	Page.		Page.
Acacia decurrens in India	242	Budd, Professor, on plums	18
— melanoxyton in India	242	Cabbage, Index to	206
Acer sacharrinum columnare	38	— List of	111
Alabama, Bulletins of	193	California, Bulletins of	194
American Florists, Society of	87	— Fruits of	12
Animal-Gun, Self-acting	180	— horticulture, Tendencies in	26
Apple in India	242-243	Canada, Bulletins of	194
— Index to	205	Canker-worm, Index to	206
Apple-picker, Cook's	183	Carica Papaya in Paraguay	233
Apple-seed separators	182	Carrot, Index to	206
Apples, Crop of	9	— List of	113
— Shipment of	10	Casava	24
Apricot	19	Cassidy, James, Obituary of	222
— from China	30	Catalogue of kitchen garden veg-	
— Index to	205	etables	106
Arkansas, Bulletins of	194	Cauliflower, Index to	206
Arsenites for the plum curculio	63	— List of	113
— table of experiments	68	Caywood, Andrew J., Obituary	
Artichoke, List of	108	of	217
Asparagus in Paraguay	237	Celeriac, List of	114
— Index to	205	Celery, Index to	207
— List of	108	— List of	114
Association, Florists' Hail	89	Cemetery Superintendents, As-	
Bag-worm, Index to	205	sociation of	92
Banana	23	Cherries for Iowa	18
— in Paraguay	232	— for Southern Iowa	18
Barrel, Ventilated	183	Cherry, Index to	207
Bean, Index to	206	Chicory, List of	114
— List of	108	Chinese lilac	38
Beet, Index to	206	Chinese or Sand pear	30
— List of	110	Chorlton, William, Obituary of	224
— Mangel Wurzel and Sugar	110	Chrysanthemum, National So-	
Berkeley, Miles Joseph, Obitu-	229	ciety	89
ary of	229	— notes, by Edwin Lonsdale	41
Bernède, Pierre, Obituary of	11	— Original large-flowered	40, 41
Berries, Crop of	206	— shows of 1889, by John Thorpe	46
Blackberry, Index to	206	— Society, Show of	46
Black-knot, Index to	241	Chrysanthemums, Brief history	
Blue-gum in India	229	of	39
Boncenne, Felix, Obituary of	213	— New, by John Thorpe	51
Books, List of	164	— of 1889, by H. P. Walcott	53
Botanical gardens, List of	83	— to be sent out	44, 45
Botanic Gardens, Missouri	111	Cider and Vinegar-Makers' As-	
Brussels Sprouts, List of	111	sociation	92

	Page.		Page.
Citrus Aurantium in Paraguay	232	Flower support	191
— Limetta in Paraguay	232	Forbes, Experiments of	67
— Limonium in Paraguay	232	Frost protectors	181
— medica in Paraguay	232	Fruit car, Maxfield	184
Clematis Davidiana	39	— crops in general	9
Colorado, Bulletins of	195	— ladder	176
Conturier, Henry Victor, Obitu- ary of	230	Fruits, California	12
Cook, Experiments with curculio	65	— List of	96
— on Paris green	64, 68	— Northeast	19
Copper label	181	— Oriental	28
Coquillet, Mr., on breeding <i>Ve-</i> <i>dolia cardinalis</i>	62	— Southern, The newer	21
Corn, pop, List of	114	Fumigator, Simple English	188
— sweet, Index to	207	Gaulin, M., Obituary of	230
— List of	115	Georgia, Bulletins of	196
— salad, (<i>Fetticus</i> .) List of	116	Ginko biloba fastigiata	38
Cranberries, Crop of	11	Girdler, Vine	176
Cranberry, Index to	207	Gooseberry, Index to	208
Cress, List of	116	Grape-hoe	174
Crops, Fruit	9	Grape, Crop of	11
Cucumber, Index to	207	— Index to	208
— List of	116	— in Paraguay	233
Curculio, Arsenites for	63	— Niagara	24
— Experiments with	65, 69	Green-house, Cat-guard for	186
Currant, Index to	207	— Index to	208
Cut-worm, Index to	207	Guava	23
Dakota, Bulletins of	195	— in Paraguay	233
Dandelion, List of	117	Gun, self-acting animal	180
Date, Index to	208	Hail, Florists' Association of	89
Delaware, Bulletins of	195	Hale, Austin M., Obituary of	224
Department of Agriculture, work of	71	Henderson, John, Obituary of	229
Directories, List of	156	Hill, E. G., on newer roses	55
Drummond, Capt. J. H., Obitu- ary of	228	Hill & Co., varieties of chrysan- themums	45
Economic entomology	61	History of chrysanthemums	39
Egg-plant, Index to	208	Horticultural literature	193
— List of	117	— work of experiment stations	75
Endive, List of	117	Horticulture, Tendencies in Cal- ifornia	26
Entomology, Economic	61	Horticulturists, List of	162
Eucalyptus globulus in India	241	Hoskins, Dr., List of fruits	20
— obliqua in India	242	— on grapes	20
— rostrata in India	242	Hot-bed frame	184
Eugenia cauliflora in Paraguay	234	Hydrangea paniculata grandi- flora	39
Experiment stations, Horticul- turists of	162	— vestita	39
— Work of	75	Hydrant, Home made	180
Fiber plants	24	Icerya Purchasi	62
Figs	22	Illinois, Bulletins of	196
Fig in California	26	India, Trees and fruits in	240
— in Paraguay	234	Indiana, Bulletins of	196
Florida, Bulletins of	195	Insects	59
— peaches, by G. L. Taber	25	Insect ravages, Laws for	69
— orange combine	14	Insecticides, Index to	208
Florists' Hail Association	89	Introductions of 1889	96
Flower, National	82	Iowa, Bulletins of	196
— pot, Improved	192	Jamaica Indian sorrel	24
		Japanese oranges	31
		— plums	30

	Page.		Page.
Juneberry, Index to	208	Olive	23
Kaki, Index to	208	— Index to	209
Kale, Index to	208	Onion drag	174
— List of	117	Onion, Index to	209
Kansas, Bulletins of	196	— List of	121
Kentucky, Bulletins of	197	Orange, Crop of	11
Kohl Rabi, List of	118	— in Paraguay	232
Laburnum pendulum	39	— Index to	200
Ladder for fruit	176	— industry	15
Lady-birds	62, 63	— wrapping machine	184
Lawn edger, Lightning	181	Oranges	22
Leek, List of	118	— Japanese	31
Lettuce, Index to	209	Oregon, Bulletins of	201
— List of	118	Organizations	13
Lonsdale, Edwin, on chrysan- themums	41	Oriental fruits	28
Louisiana, Bulletins of	197	— — List of	31
Maine, Bulletins of	197	Ornamental gardening, Tenden- cies in	33
Maiz in Paraguay	235	— plants, List of	96
Mandioca in Paraguay	234	Ornamentals, by F. L. Temple	34
Marnock, Robert, Obituary of	228	Ornamentals	19, 33
Martins, C. F., Obituary of	230	Paraguay, Horticulture in	231
Maryland, Bulletins of	197	Paris green	64
Massachusetts, Bulletins of	197	Parsley, List of	122
McKenzie, J. A., Obituary of	229	Parsnip, Index to	209
McMillan, Essay by	34	— List of	123
McNeill pea	24	Pathology, Vegetable	59
Measures and Weights, Irregu- larities in	80	Payne, Harman C., on chrysan- themums	39
Melon, Index to	209	Pea, Index to	209
Melons in Paraguay	236	— List of	123
Michaud, J. E., Obituary of	235	Pea-nuts in Paraguay	236
Michigan, Bulletins of	197	Peach, Index to	210
Minnesota, Bulletins of	198	— in Paraguay	233
Missouri botanic gardens	83	Peaches	19
Missouri, Bulletins of	198	— Chinese	29
Mole trap	179	— Crop of	10
Morel, Pierre, Obituary of	230	— Florida, by G. L. Taber	25
Mulberry, Index to	209	— Varieties of for the South	21
Musk melon, List of	120	Pear, Chinese or Sand	30
Mustard, List of	121	— in India	242
Myrica rubra	31	— Index to	230
Naming of vegetables	78	Pears for prairie states	17
Nasturtium, List of	121	Pennisetum sp.	24
National and educational inter- ests	71	Pennsylvania, Bulletins of	201
National flower discussion	82	Pepper, Index to	210
National societies for 1889	86	— List of	125
Nebraska, Bulletins of	198	Periodicals, List of	214
New Jersey, Bulletins of	199	Persimmon, Index to	210
New York, Bulletins of	199	— Japanese	23, 29
North Carolina, Bulletins of	200	Pineapple	9
Northeast, Fruits for	19	— in Paraguay	232
Nuts, Index to	209	Pinus Strobus zebrina	39
Nurserymen, Association of	91	Pithecolobium dulce in India	244
Nurserymen, List of	169	Plant diseases	59
Ohio, Bulletins of	200	— — laws to control	69
Okra, List of	121	— portraits of 1889	141
		— protector	177

	Page.		Page.
Plant stand, Harris' iron . . .	191	Roses . . .	55
— support . . .	191	Rubus Molluccanus in India . . .	244
Plow, Pearce's orchard gang . . .	174	— racemosus in India . . .	244
Plum, Apricot . . .	30	Sage, List of . . .	136
— curculio, Arsenites for . . .	63	Sagot, M., Obituary of . . .	229
— Experiments with . . .	66	Salads in Paraguay . . .	237
— Index to . . .	210	Salix vitellina . . .	39
— Japanese . . .	30	Salsify, List of . . .	136
— for prairie states . . .	18	Schrevels, Louis Delrue, Obitu- ary of . . .	235
— for the south . . .	22	Scuffle-hoe . . .	174
Pomegranate . . .	23	Seeds, Index to . . .	211
Pomelo, Index to . . .	210	Seedsman, List of . . .	169
Post bar, Eclipse . . .	176	Seed-planter, Tracy's . . .	191
Potato, Index to . . .	210	Seed separators, Apple . . .	182
— in Paraguay . . .	235	Seed testers . . .	181
-- List of . . .	125	Seed Trade Association . . .	94
— sorter . . .	183	Shaw, Henry, Obituary of . . .	220
— Crop of . . .	12	Shrubs and trees for cold north . . .	16
— Imports of . . .	13	Societies, National . . .	86
Pot collar . . .	192	Society American Florists . . .	87
— washer . . .	190	— Directories of . . .	157
Prairie states, Apples and pears for . . .	17	Solanum Guatemalense . . .	23
— — Plums for	18	Sorrel, List of	137
Prices and yields of 1889 . . .	9	South Carolina, Bulletins of . . .	201
Propagating case, portable . . .	190	South, The newer fruits of . . .	21
— tank	188	Spinach, Index to . . .	212
Propagator, Zinc	190	— List of	137
Protective Association, Florists' . . .	90	Squash, Index to . . .	212
Pruner for prickly bushes . . .	176	— List of	137
Pruning shears . . .	176	Strawberries, Crop of . . .	11
Prunus Hattan . . .	30	— Index to	212
— platycarpa . . .	30	Strawsonizer	177
— Simoni	30	Styrax reticulata in Paraguay . . .	234
Psidium Guineense . . .	23	Sweet potato, Index to . . .	212
— pomiferum in Paraguay . . .	233	— List of	138
Pumpkin, Index to . . .	211	Syringa Japonica	37
— List of	135	— ligustrina Pekinensis pendula . . .	38
Pyrus Malus Parkmanni . . .	38	— oblata	38
Quihou, M., Obituary of . . .	230	— villosa	38
Quince, Index to . . .	211	Taber, G. L., on Florida peaches . . .	25
Radish, Index to . . .	211	Temple, F. L., on ornamentals . . .	34
— List of	135	Tennessee, Bulletins of	201
Rape, List of	136	Texas, Bulletins of	201
Raspberry, Index to . . .	211	Thorpe, John, chrysanthemum show	46
— in India	244	— new chrysanthemums	51
Reasoner, E. N., on southern fruits	21	Tobacco trough	188
Red-gum in India	242	Tomato, Index to	212
Reichenbach, Heinrich Gustav, Obituary of	226	— List of	138
Rhode Island, Bulletins of . . .	201	Tools	174
Rhubarb, Index to	211	Trees and shrubs for the cold north	16
— List of	136	Trowel, Cleves' angle	177
Robinca pseudacacia mimosæ- folia	39	Turnip, flat, List of	139
Root-knot, Index to	211	— Index to	212
Rose, Index to	211	— Ruta-baga, List of	139
		United States, Bulletins of	201

	Page.		Page.
Vedolia cardinalis	62	Vinegar-Makers' Association	92
Vegetables, Catalogue of .	106	Virginia, Bulletins of . . .	204
Vegetable crops in general	12	Walcott, H. P., chrysanthemums	
Vegetables, List of	96	of 1889 . . .	53
Vegetable pathology	59	Ward, Dr., Obituary of . . .	229
Vegetables, Rules for naming	78	Waterer, H., varieties of chrys-	
Ventilator, Automatic	185	anthemums . . .	44
— Cheap	186	Watermelon, List of . . .	149
— shaft support	185	Weed on arsenites . . .	65, 66
— Wind-tight . . .	184	Weights and measures, Irregu-	
Vermont, Bulletins of . . .	204	larities in . . .	80
Vidal, Don Sebastian, Obituary		Windbreaks, Index to . . .	212
of . . .	229	Wisconsin, Bulletins of . . .	204
Vine girdler	176	Yields and prices of 1889 . . .	9

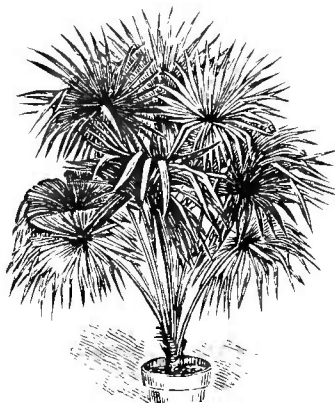

Devolva à
Biblioteca da "Luiz de Queiroz"
na última data fixada



ORIENTAÇÕES PARA O USO

Esta é uma cópia digital de um documento (ou parte dele) que pertence a um dos acervos que fazem parte da Biblioteca Digital de Obras Raras e Especiais da USP. Trata-se de uma referência a um documento original. Neste sentido, procuramos manter a integridade e a autenticidade da fonte, não realizando alterações no ambiente digital – com exceção de ajustes de cor, contraste e definição.

1. Você apenas deve utilizar esta obra para fins não comerciais. Os livros, textos e imagens que publicamos na Biblioteca Digital de Obras Raras e Especiais da USP são de domínio público, no entanto, é proibido o uso comercial das nossas imagens.

2. Atribuição. Quando utilizar este documento em outro contexto, você deve dar crédito ao autor (ou autores), à Biblioteca Digital de Obras Raras e Especiais da USP e ao acervo original, da forma como aparece na ficha catalográfica (metadados) do repositório digital. Pedimos que você não republique este conteúdo na rede mundial de computadores (internet) sem a nossa expressa autorização.

3. Direitos do autor. No Brasil, os direitos do autor são regulados pela Lei n.º 9.610, de 19 de Fevereiro de 1998. Os direitos do autor estão também respaldados na Convenção de Berna, de 1971. Sabemos das dificuldades existentes para a verificação se uma obra realmente encontra-se em domínio público. Neste sentido, se você acreditar que algum documento publicado na Biblioteca Digital de Obras Raras e Especiais da USP esteja violando direitos autorais de tradução, versão, exibição, reprodução ou quaisquer outros, solicitamos que nos informe imediatamente (dtsibi@usp.br).